

SHOCKS, STRUTS, CARTRIDGES & GASLIFTS

2018-2019



Torre

Parts and Components

Torre Parts and Components manufactures and distributes quality branded parts and components into the African market and operates across four distinct market segments namely, Automotive, Commercial, Off Highway and Industrial. Established in 1948, the company owns or represents a significant basket of well-known brands which include **Gabriel, Autocom, Echlin, VDO, ACSA-Mag, Textar, MagBrakes, SKF, Permatex Warn, Hi-Lift, Vision-X, Truck-Lite, Puisi, Pneumax, Raasm and Liquip.**

Based in City Deep in Johannesburg, with manufacturing operations in the Western Cape and Port Elizabeth, **Torre Parts and Components** employs some 500 people dedicated to its sales, marketing, warehousing, manufacturing and distribution operations, serving a network of customers throughout Africa.

Torre Parts and Components is both ISO9001 and ISO14001 certified as well as being an SABS certified company with a variety of supply contracts to both the aftermarket and original equipment markets.



Torre

Industries

Torre Industries Ltd is a Johannesburg Stock Exchange Listed industrial group that provides equipment, parts, financing and support services to its customers in selected high growth markets.

Torre's business is the value added sale and rental of branded capital equipment, the distribution of high quality aftermarket parts, the delivery of critical support services and the provision of financing solutions in support of our customer's expansion programmes.

Torre Industries is highly focused on the expansion and optimisation of our existing subsidiaries. In addition to our organic growth strategy, we are committed to a systematic acquisition strategy with all target companies operating in identified market sectors in which **Torre** seeks to operate. They must have an established market position with the inherent ability to grow sustainable earnings and cash flow once they become part of the Torre group.

The **Torre** business model has already evolved from one that was driven primarily by acquisitive growth to one that is focused on organic initiatives, with acquisitions as an additional growth engine. Over time it is expected that the growth attributable to acquisition activity will continue to decrease as a proportion of the overall growth of the business.

IntelPart

Your Online Catalogue and
Purchasing Solution



www.intelpart.com
www.torreparts.com

 **Torre**
Parts and Components
Experience The Support



IntelPart is your gateway to **Torre Parts and Components** complete range of Automotive, Commercial, Off-Highway and Industrial products at your fingertips. **IntelPart** offers the latest product, technical and cross reference information when and where you need it most.

The **IntelPart** online catalogue and ordering interface is fast, secure giving your business the benefit of sourcing, procuring and supplying parts from **Torre Parts and Components** and offers numerous features to assist in product search, order generation and saving regularly ordered parts. **IntelPart** also allows you to enter your entire order and will automatically place, process and release your order for delivery with **Torre Parts and Components**, making it your one stop online parts partner.

IntelPart gives you the option to track and trace your order, reprint invoices and delivery notes when and where required.

The ease of **IntelPart**'s dynamic search functionality in locating and identifying required parts is simple. 20 easily identifiable product categories simply guide you to refine your search to those parts you require or you can simply locate parts by part number, vehicle application or cross reference. The intelligent keyword search features will streamline the way you order parts. A key feature of **IntelPart** is that it gives you real time pricing and availability!





The ever-changing needs of your business is what drives IntelPart to continually update and meet your expectations.

- 22 000 parts listed
 - Dynamic, Real-time Search and Referencing
 - New Product Listings
 - Special Offers
 - Clearance Sale Deals
 - Quick Orders
 - My Lists (Favourite orders builder)
 - My Frequently Ordered Items
 - Customer Quote Builder
 - Account Status and Overview
- To register, simply log on to www.intelpart.com or contact your **Torre Parts and Components** sales representative for a demo.

www.intelpart.com

How to use the Catalogue	2
--------------------------	---

SHOCKS, STRUTS & CARTRIDGES

	Overview	7
	Product Range	8
	Vehicle Listing	13
	• Passenger Vehicles	14
	• Heavy Commercial Vehicles (HCV)	45
	Parts Listing	59
	Parts Finder	123
	Technical Information	153
	• Key to Mounting Codes	154
	• How to Measure Extended and Collapsed Lengths	154
	• How to Protect your Struts	154
	• Technical guide to drawings	155
	• Removal and fitment of shocks	156
	• Removal and fitment of struts	157
	• Parts Listing	158

GASLIFTS & STEERING DAMPERS

	Product Range and General Information	176
	Gas Filling Machine	178
	Gaslifts Custom Range	179
	Vehicle Listing	180
	Parts Listing	182
	Parts Finder	185
	Technical Information	185
	• Universal Gaslifts	185
	• Extended & Collapsed Lengths	186
	Steering Dampers	191

TERMS & CONDITIONS

Warranty Policy	192
Processing a Warranty	193
Brands of Torre Parts and Components	195

HOW TO USE THE CATALOGUE

VEHICLE LISTING

Vehicle make sorted in alpha-numeric order

Vehicle model sorted in alpha-numeric order

Model derivative sorted in alpha-numeric order

Vehicle or shock specific information (refer to the fitment guide on page 6)

Front part numbers

Icon indicates shock type. Refer to page 5 for more details

Rear part numbers

The first part number is for the left hand side and the second part number for right hand side

Model	Derivative	Year	Vehicle Type	Note # (pg 6)	FRONT				REAR				GASLIFT		
					Shock Info	Part #	L/R	Range	Shock Info	Part #	L/R	Range	Front	Rear	
ALFA ROMEO															
147	1.6, 2.0 (937)	01-10				G51231	L	Gas Ryder							
						G51231	R	Gas Ryder		69919	← →	Gas Ryder			
Alfetta, Giulietta, Super	Incl. (159i, 1600, 1800, GT 1.8, 2000, 2000 GTV)	73-86		14		G45666	← →	Technomatic		G45667	← →	Technomatic		4521 Left	4522 Right
AUDI															
A3	50mm Strut Body. All (8P1) – Excl. Quattro, Sport Susp. & S3.	03-12				44602	← →	Technomatic		G45715	← →	Technomatic			
						70546	← →	Gas Ryder		69507	← →	Gas Ryder			
A3	50mm Strut Body. Sportback (8PA) Excl. Quattro, Sport Susp. & S3	05-12				70546	← →	Gas Ryder		69507	← →	Gas Ryder			

Vehicle introduction year to replacement year. For open ended periods (19...) search by model, not period

Vehicle type. Refer to page 5 for more information

Fitment position (L – Left, R – Right) or both sides (← →)

Range options available for the same vehicle model. The first listed is the preferred brand and those that follow are the alternatives.

PARTS LISTING

Part numbers in alpha-numerical order

Product range

Icon and figure indicates shock type. Refer to page 5 for more details

Refer to vehicle listing keys as per above

Vehicle or shock specific information (refer to page 6)

Part #	Range	Superceding Part #/Status	Product Type	Make	Model	Derivative	Year	Position	L/R	Note # (pg 6)
14024	Steering Damper		15	Toyota	Landcruiser	FJ62, BJ60, BJ75	83-99	Front		
				Toyota	Landcruiser	HZJ 80	90-98	Front		4
19021	Technomatic		8,5	Austin, Morris	Mini	Excl. Hydrolastic Susp.	59-85	Front	← →	
				Austin, Morris	Mini	Incl. Cooper	59-80	Front	← →	
				Austin, Morris	Mini	Incl. Mk III	61-79	Front	← →	5
19290	Technomatic		13,2	Toyota	1200	LDV	78-82	Rear	← →	
35117	Technomatic		1,1	Renault	Laguna	I (Excl. Station Wagon)	96-00	Front	← →	

HOW TO USE THE CATALOGUE

PARTS FINDER

Reference to brands, trademarks or manufacturers part numbers are for reference and identification purposes only

Part #	Manufacturer	Gabriel		Model/Year/Side
		Primary	Alternative	
R1000	Monroe	G45006		
R1581	Monroe	G45418		
R1581	Monroe	G63423		
343185	KYB	G45122		
343187	KYB	G45860		Rear Left
343367	KYB	G56116	G45872	
721573	Gabriel Europe	35018		Rear Right
721574	Gabriel Europe	35094		Rear Left
721583	Gabriel Europe	55872		

- Manufacturers part numbers in alpha-numerical order
- Alternative part manufacturers
- The primary recommended alternative
- An additional recommended alternative
- Additional information



















TECHNICAL INFORMATION – Extended and collapsed lengths

Collapsed Length	Extended Length	Upper Mounting	Lower Mounting	Shock Type			Part #
				Fig	Icon	Code	
GABRIEL GAS RYDER							
MACPHERSON STRUT – WITHOUT SPRING SEAT							
297	489	M12x1.25x23	B	1,2		RE/RE	55802
SPRING SEAT SHOCK ABSORBERS – STUD UPPER, U BRACKET LOWER							
422	672	S	UB	3,3		SS/UB	69082
436	580	S	UB	3,3		SS/UB	69087
459	580	S	UB	3,3		SS/UB	651097
GABRIEL® HEAVY DUTY							
SHOCK ABSORBERS – STUD UPPER AND LOWER							
199	303	S	S	5		S/S	83233
SHOCK ABSORBERS – STUD UPPER, RUBBER EYE LOWER							
318	506	S	RE20	6,1		S/RE	83454



- Type of damper by figure number, icon and code (refer to page 163 for more information)
- Damper part numbers
- The listings are segmented by range
- The different type of dampers in each range are listed by type
- The dampers are listed by their fully collapsed lengths
- Length of damper when fully extended
- Mounting Code at the top of the damper – refer to list in technical section
- Damper part number

HOW TO USE THE CATALOGUE

KEY DESCRIPTIONS – Icons

	All models		Electronically adjustable suspension
	Passenger Car/Sedan (4 door)		Sport suspension
	Hatchback/Fastback		Self levelling suspension
	Estate/Station wagon	L / Left	Left hand side
	Coupe	R / Right	Right hand side
	Convertible	← →	Both Left and Right Hand Side
	LCV/Pick-up/Bakkie	Excl.	Excluding
	Panel van/Commercial	Incl.	Including
	Minibus	Susp.	Suspension
	MPV	Part #	Part number
	SUV	Fig 1	Gabriel® MacPherson Strut
	Panel van/Truck	Fig 2	Gabriel® MacPherson Cartridge
	Chassis Cab	Fig 3	Gabriel® Springseat Shock Absorber
	Truck	Fig 4 to 13	Gabriel® Shock Absorbers
	Trailer	Fig 14	Gabriel® Gaslift®
	Bus	Fig 15	Gabriel® Steering Damper

Refer to technical guide to drawings on page 171 for more information

	Gabriel® MacPherson strut		Eye and stud shock absorber
	Gabriel® MacPherson cartridge		Eye and barpin shock absorber
	Gabriel® Springseat shock absorber		Eye and special mounting shock absorber
	Stud and barpin shock absorber		Barpin and stud shock absorber
	Stud and stud shock absorber		Barpin and eye shock absorber
	Stud and eye shock absorber (with or without dust cover)		Gabriel® Gaslift®
	Stud and special mounting shock absorber		Gabriel® Steering damper
	Eye and eye shock absorber		

HOW TO USE THE CATALOGUE

FITMENT GUIDE INSTRUCTION NOTES*

Note	Fitment Guide
1	Fit 2.5mm spacer either side lower sleeve front mounting
2	For rear use 414075 for lower mounting
3	For rear use sleeve 414164 and 414081 – top and bottom
4	Imported Beetle front use 19289, remove bar pin, fit 404702 + 414167
5	Remove lower sleeve
6	Remove top front shock bushing – fit 404702 plus 414167 remove sleeve lower mount
7	Re-use rear lower mounting bushes
8	Re-use rear lower mounting bushes. Using G45874 OR 61242 upside down does not work
9	Re-use spring seat upper mounting and bump rubber for rear shock
10	Use 414371 retainer (M48 x 1.0) for front
11	Use existing rear mounting
12	Use existing upper front mounting
13	Use existing upper rear assembly
14	Use existing upper rear mounting
15	Use kit 140729 for rear
16	Use kit 144028 x 2 for front and rear mountings
17	Use retainer 414334 with RS2000

Note	Fitment Guide
18	Use retainer 414363 (M48 x 1.5) when replacing Bilstein O.E. front units. Use existing upper rear mounting
19	Use sleeve 414167 lower for rear mounting
20	Use sleeve 414167 upper and lower for rear
21	When replacing struts with welded brake brackets use 414480 & 414481 brackets for rear
22	With rear lower eye mounting
23	With rear lower mounting bracket
24	Only fits applications with one pin at the bottom strut mounting
25	Re-use spring seat, upper mounting and bump rubber for rear shock
26	76042 for models with 25mm rubber bushes upper and lower. 76017 for models with 20mm sleeves upper and lower
27	77022 with Neway ARD 125/244 air suspension. 77018 with Hendrickson TA 460 air suspension
28	O.E. 16-13947-000 or 6913260400 for 85319 and O.E. 16-13957-000 or 680339 for 85724
29	Some use G56102 with 16mm eyes
30	Use 20mm spacer on lower mounting
31	Use 4 x 401754 rubber bushes
32	Use rubber bush 414323 x 2 for front and rear
33	Refer to fitment instructions located inside the box

* Should a fitment guide number not be specified, please revert to the standard fitment instructions on pages 156 and 157



OVERVIEW

Gabriel designs, engineers and manufactures shock absorbers for both the South African and international markets.

Gabriel's state of the art manufacturing facility (based in Retreat, Cape Town) houses its own product development, engineering and manufacturing divisions whereby products is designed and manufactured to the highest quality standards and distributed throughout the African continent.

All genuine Gabriel products are comprehensively tested by a team of qualified engineers and Gabriel's comprehensive range of shock absorbers are specifically designed and engineered to suit local South African conditions.

The Gabriel range includes:

- Gas and hydraulic shock absorbers
- MacPherson struts and cartridges
- Steering dampers
- Gaslifts®
- Accessories

The Gabriel product range is supplied through its wide distribution network under the following well known brands:

- Gabriel® Gas Rider™,
- Gabriel® Safari™
- Gabriel® Safari HDP™
- Gabriel® Technomatic™
- Gabriel® Fleet Ryder®
- Gabriel® Gaslifts®

Drivers who use Gabriel shock absorbers comment on the smooth ride of their vehicles, however shock absorbers are not just for comfort – their primary purpose is to keep the wheels in contact with the road surface. Shock Absorbers also affect the steering, handling and braking of your vehicle, which is why they are vital for your safety.

Our years of research and testing have resulted in Gabriel developing shock absorbers that are firm enough to prevent the wheels from leaving the road surface, but also flexible enough to ensure that the occupants are not directly subjected to the vehicle's forces.

Gabriel shock absorbers limit the bounce of the wheels by controlling the rate at which the suspension springs compress and extend. In doing so, the shock absorbers help maintain traction and control of the body, as well as the pitch and roll of the car during cornering, braking and acceleration. With more accurate control and steering, Gabriel shock absorbers enhance safety through good road holding.







PRODUCT RANGE

PRODUCT FEATURES AND BENEFITS

Product Area	Product Type	Product Feature and Benefits	Brand:						
			Vehicle Type:	Passenger vehicles, MPV & SUV		MPV, SUV, LDV, MCV & Older Passenger Cars		MCV, HCV	Vehicle & Industrial
			Range:	Premium Range	Standard Range	On & Off Road Range	On & Off Road Heavy Duty Range	Heavy Duty Truck and Bus Range	Vehicle & Industrial Gas Stay Range
Design Type	Shock Absorber	Designed for all types of vehicles	✓	✓	✓	✓	✓		
	Spring Seat	Designed for mainly passenger and SUV's	✓	✓	✓	✓			
	Gaslift	Designed for automotive and industrial applications						✓	
	Twin Tube	Designed for all types of vehicles	✓	✓	✓	✓	✓		
	Mono Tube	Designed for mainly SUV's and MPV's	✓		✓	✓			
	MacPherson Struts	Designed for mainly passenger vehicles	✓	✓					
Suspensions	Standard	The vast majority of vehicles in South Africa	✓	✓	✓	✓	✓		
	Air Suspensions	A limited amount of vehicles in South Africa					✓		
	Raised	Specialist vehicle applications, mainly custom 4x4's				✓			
Bore Size	Working Cylinder Bore Size (mm)	The larger the bore size the better the energy dissipation	27/30/32/36	27/32	32	35/41/46	41/52	19/22	
Oil	Custom Formulated Oil	Specially formulated oil to meet Gabriel's specifications	1200 C	1200 C	1200 C	1800 C	1200 C	80°C	
Gas and Pressures	Hydraulic	Standard feature on most shocks		✓			✓		
	Low Pressure gas	Gives a faster response time and less chance of the oil foaming		✓	✓			Variable pressure	
	Nitrogen infused	Gives a much faster response time and less chance of the oil foaming	✓	✓	✓	✓			
	High Pressure	Gives exceptional ride control and a quicker response time	✓			✓			
Bushing	Natural Rubber	Designed to match original equipment durability properties	✓	✓	✓	✓	✓		
	Polyurethane	Designed to exceed original equipment durability properties			✓	✓			
Seals	Viton or rubber rod seals	Designed to withstand high operating temperatures	✓	✓	✓	✓			
	Single lip rod seals	Designed as a standard feature with good wear properties	✓		✓		✓	✓	
	Multi lip rod seals	Specifically designed for better sealing and longer life expectancy	✓	✓	✓		✓		
	Rubber o-ring piston seals	Designed as a standard feature with good wear properties	✓						
	PTFE band o-ring piston seals	Specifically designed for reducing friction and providing longer product usage	✓	✓	✓				
	Cast iron o-ring piston seals	Specifically designed for reducing friction and providing longer product usage				✓	✓		
Rods and Product Finishing	Chrome plated & trication of zinc phosphate shaft (piston rod)	Highest quality finish on rods to reduce wear and protect against rust	✓	✓	✓	✓	✓	✓	
	Sintered (combination of metals) metal rod guides	Standard feature on most Gabriel shocks	✓	✓	✓				

PRODUCT RANGE

PRODUCT FEATURES AND BENEFITS

Product Area	Product Type	Product Feature and Benefits	Brand:	     					
			Vehicle Type:	Passenger vehicles, MPV & SUV		MPV, SUV, LDV, MCV & Older Passenger Cars		MCV, HCV	Vehicle & Industrial
			Range:	Premium Range	Standard Range	On & Off Road Range	On & Off Road Heavy Duty Range	Heavy Duty Truck and Bus Range	Vehicle & Industrial Gas Stay Range
Additional Design Criteria	Cast iron piston ring	Allows for greater durability in high operating temperatures than the alternative Teflon type ring				✓	✓		
	Teflon DU piston band insert	Designed to reduce friction between the rod and rod guide	✓	✓	✓				
	Bump Stop support	Designed to stop metal to metal contact and such damage to the shock	✓	✓					
	Strike Plate bump stop support	Designed to stop metal to metal contact and such damage to the shock		✓	✓				
	Velocity sensitive valving	Specifically designed to adjust the ride and handling performance based on differing factors such as road surface and speed	✓			✓			
	Hydraulic lock	Designed to prevent metal to metal contact under full extension and such damage to the shock				✓			
	360° Reinforce welded mounts	Increased weld strength for extreme conditions as opposed to 180 and tack welds				✓			
	Solid machined eye rings	Provides for stronger and more durable mountings as opposed to split types	✓			✓			
Colouring	White	Electrostatically applied paint (cosmetic)		✓	✓			✓	
	Black	Electrostatically applied paint (cosmetic)	✓				✓	✓	
	Green	Electrostatically applied paint (cosmetic)				✓			
Dust Covers	Metal	A Standard feature that protects your product from damage	✓	✓	✓		✓		
	Rubber/Plastic	A Standard feature that protects your product from damage	✓	✓		✓			
Accreditation	ISO 9000	Piece of mind that our quality production standards are met (International)	✓	✓	✓	✓	✓	✓	
	ISO 14001	Piece of mind that our quality production standards are met (International)	✓	✓	✓	✓	✓	✓	
	SABS	Piece of mind that our quality production standards are met (local RSA)	✓	✓	✓	✓	✓	✓	
Warranty Period	Standard - Time (Years)	Gabriel quality guarantee	3	3	3	3	1	1	
	Standard - Distance (Km)	Gabriel quality guarantee	Unlimited	Unlimited	Unlimited	Unlimited	20 000	Unlimited	
	Extended 3 to 5 Year	Gabriel quality guarantee	✓	✓	✓	✓			

PRODUCT RANGE

GABRIEL® GAS RYDER™

The Gabriel Gas Ryder Series offers an extensive range of South African shock absorbers, spring seat shock absorbers, MacPherson struts and MacPherson cartridges for passenger cars, sports cars, station wagons, small LCV's, MPV's and SUV's.

With the unique nitrogen gas-pressured dynamic response design, Gabriel Gas Ryder gives both an exceptional ride as well as a quicker response time compared to ordinary shock absorbers – the ultimate in both comfort and safety.

Allowing for greater ride control and performance, comfort and ultimately safety, the Gabriel Gas Ryder and its Gabriel warranty delivers up to its historical South African pedigree and provides for total driving peace of mind.



GABRIEL® GAS RYDER™ STRUT



GABRIEL® GAS RYDER™ SPRING SEAT



GABRIEL® GAS RYDER™ SHOCK



GABRIEL® GAS RYDER™ CARTRIDGE

GABRIEL® TECHNOMATIC™

The Gabriel Technomatic Series offers an extensive range of robust and genuine South African shock absorbers, spring seat shock absorbers, MacPherson struts and MacPherson cartridges for today's passenger cars. Station wagons, MPV and LCV applications for use on both tar and gravel road surfaces.

Providing a firm yet comfortable ride with a fast response time, the Gabriel Technomatic Series and its Gabriel warranty delivers up to its historical South African pedigree and provides for total driving peace of mind.



GABRIEL® TECHNOMATIC™ STRUT CARTRIDGE



GABRIEL® TECHNOMATIC™ STRUT



GABRIEL® TECHNOMATIC™ SPRING SEAT



GABRIEL® TECHNOMATIC™ SHOCK

PRODUCT RANGE

GABRIEL® SAFARI™

The Gabriel Safari Series offers an extensive range of genuine, robust large bore South African oil and gas shock absorbers catering for the demanding requirements of today's light commercial, heavy passenger vehicles, station wagon, South African taxi's, SUV and MPV applications both on and off-road.

Allowing for greater ride control, comfort and ultimately safety, the Gabriel Safari Series and its Gabriel warranty delivers up to its historical South African pedigree and provides for total driving peace of mind.



GABRIEL® SAFARI™ SPRING SEAT SHOCK



GABRIEL® SAFARI™ GAS SHOCK

GABRIEL® SAFARI HDP™

The Gabriel Safari HDP is a genuine robust, technologically advanced, big bore shock absorber specifically designed and manufactured in South Africa to cater for the heavy-duty performance requirements of today's SUV, 4x4 and light commercial applications.

Allowing for greater ride control and increased comfort over other comparative shock absorbers in the market, the Gabriel Safari HDP and its 3 year unlimited kilometer warranty delivers up to its historical Gabriel pedigree and also sets a new standard for performance based shock absorber applications.



GABRIEL® SAFARI HDP™ SHOCK



GABRIEL® SAFARI HDP™ SPRING SEAT SHOCK





VEHICLE LISTING – SHOCKS, STRUTS & CARTRIDGES PASSENGER & LIGHT COMMERCIAL VEHICLES

The Vehicle Listing section is an easy to use vehicle reference to all Gabriel part numbers, product ranges and technical information according to the specific vehicle make, model, derivative and year: This Includes all passenger cars, MPVs, SUVs, 4X4s, Pick-ups, Trucks and Busses.

The product ranges that are highlighted in this section include the Gabriel Gas Ryder™, Safari™, Safari HDP™, Technomatic™, Fleet Ryder® and Heavy Duty Shocks, Struts and Cartridges.

Where a vehicle is referenced to more than one part number/range of Gabriel product, please refer to the section at the beginning of the catalogue (beginning on page 7) where we define the main features, benefits, placement and warranty of each range offered.

The preferred part number/range for each application listing is always listed at the top with preferred alternatives below.

Section Content	Page
 Passenger & Light Commercial Vehicles	14
 Heavy Commercial Vehicles	45



A

Model	Derivative	Year	Vehicle Type	Fitment Guide# (pg 6)	FRONT			Rear				GASLIFT		
					Shock Info	Part #	L/R	Range	Shock Info	Part #	L/R	Range	Front	Rear
ALFA ROMEO														
147	1.6, 2.0 (937)	01-10			†	G51231	↔	Gas Ryder						
155	2.0	96-98							⊖	69919	↔	Gas Ryder		
155	2.5	96-98							⊖	69919	↔	Gas Ryder		
156	2.0 Twin Spark (932) (Excl. ⚡) (→VET0116245)	97-98			†	G51217	↔	Gas Ryder						
					†	G51217	↔	Gas Ryder						
156	2.5 V6 (932) ⚡ (VET0116246→)	98-06			†	G51231	↔	Gas Ryder						
156	2.5 V6 (932) ⚡ (→VET0116245)	97-98			†	G51231	↔	Gas Ryder						
Alfetta, Giulietta, Super	Incl. (159i, 1600, 1800, GT 1.8, 2000, 2000 GTV)	73-86			±	G45666	↔	Technomatic	+	G45667	↔	Technomatic		
Other	Incl. Giulia	66-77			⊖	G45122	↔	Technomatic						
AUDI														
80	B1 (1600 GL, GLS)	75-81			/	44602	↔	Technomatic	⊖	G45715	↔	Technomatic		
100, 200	C2	77-84		14	/	61303	↔	Gas Ryder	⊖	36853	↔	Technomatic		
100, 200	Excl. Coupe (C1)	72-74		12					⊖	36854	↔	Technomatic		
100, 200	Excl. Coupe (C1)	75-77		12					⊖	36854	↔	Technomatic		
400, 500	C3, C4	83-94		14	/	61303	↔	Gas Ryder	†	69072	↔	Gas Ryder	4081	
A3	50mm Strut Body. All (8P1) – Excl. Quattro, Sport Susp. & S3.	03-12			†	70546	↔	Gas Ryder	⊖	69507	↔	Gas Ryder		
A3	55mm Strut Body. All (8P1) – Excl. Quattro, Sport Susp. & S3.	03-12			†	70640	↔	Gas Ryder	⊖	69507	↔	Gas Ryder		
A3	50mm Strut Body. Sportback (8PA) Excl. Quattro, Sport Susp. & S3.	05-12			†	70546	↔	Gas Ryder	⊖	69507	↔	Gas Ryder		
A3	55mm Strut Body. Sportback (8PA) Excl. Quattro, Sport Susp. & S3.	05-12			†	70640	↔	Gas Ryder	⊖	69507	↔	Gas Ryder		
A3	Excl. S3 (8L1)	98-03			†	55872	↔	Gas Ryder	⊖	61262	↔	Gas Ryder		
A4	1.8, 2.4, 2.6, 2.8 Excl. Quattro (B5 model)	94-01			†	69087	↔	Gas Ryder	†	G51023	↔	Gas Ryder		
A4	Quattro Excl. Sport Susp. (B5)	94-01			†	69087	↔	Gas Ryder						
A4	Excl. Sport Susp. (B6 model)	01-05			†	69101	↔	Gas Ryder	⊖	61298	↔	Gas Ryder		
A4	Avant & Quattro (Sport Susp.) (Excl. All Road, S4 & RS4 – B7 model)	05-08							⊖	62003	↔	Gas Ryder		
A4	B7 model (Excl. Sport Susp.)	05-08			†	69101	↔	Gas Ryder	⊖	62024	↔	Gas Ryder		
A4	B8 model (Excl. Sport Susp., Quattro & S4)	08 on			†	69119	↔	Gas Ryder	⊖	62057	↔	Gas Ryder		

VEHICLE LISTING

Shocks, Struts, Gaslifts & Cartridges – Passenger

ALFA ROMEO



A

Model	Derivative	Year	Vehicle Type	Fitment Guide# (pg 6)	FRONT				Rear				GASLIFT	
					Shock Info	Part #	L/R	Range	Shock Info	Part #	L/R	Range	Front	Rear
AUDI (CONT...)														
A6	Incl. Avant. Excl. Quattro (C4)	94-97		14	/	61303	↔	Gas Ryder	†	69072	↔	Gas Ryder		
A6	Excl. & Quattro (C5)	97-04			†	651101	↔	Gas Ryder	⊖	69946	↔	Gas Ryder		
A6	Quattro (C5)	97-04			†	651101	↔	Gas Ryder						
A6 – C6 (Type 4F)	All Excl. Air Susp.	04-11							⊖	62034	↔	Gas Ryder		
AUSTIN, MORRIS														
Mini	Excl. Hydrolastic Susp.	59-85			⊖	19021	↔	Technomatic	⊖	19022	↔	Technomatic		
Mini	Incl. Cooper	59-80			⊖	19021	↔	Technomatic	⊖	19022	↔	Technomatic		
Mini	Incl. Mk III	61-79			⊖	19021	↔	Technomatic	⊖	19022	↔	Technomatic		
BMW														
1 Series	E87 5-Door (Excl. Sport Susp. & 135i)	04-11			†	70577	L	Gas Ryder	†	69102	↔	Gas Ryder		
					†	70578	R	Gas Ryder	†	69102	↔	Gas Ryder		
1 Series	E81 3-Door (Excl. Sport Susp. & 135i)	07-11			†	70577	L	Gas Ryder	†	69102	↔	Gas Ryder		
					†	70578	R	Gas Ryder	†	69102	↔	Gas Ryder		
1 Series	E82 Coupe (Excl. Sport Susp. & 135i)	08 on			†	70577	L	Gas Ryder	†	69102	↔	Gas Ryder		
					†	70578	R	Gas Ryder	†	69102	↔	Gas Ryder		
1 Series	E88 Cabriolet (Excl. Sport Susp. & 135i)	08 on			†	70577	L	Gas Ryder	†	69102	↔	Gas Ryder		
					†	70578	R	Gas Ryder	†	69102	↔	Gas Ryder		
2 Series	1502, 2002 Ti Lux (E10)	66-77							⊖	36857	↔	Technomatic		
2 Series	1802, 2002 (E10)	68-75			⊖	645532	↔	Technomatic	⊖	645861	↔	Technomatic		
3 Series	E30 Series (Excl. iS & Cabriolet)	83-91		14	/	44085	↔	Technomatic	⊖	36857	↔	Technomatic	4060	
3 Series	E36 Series Imported 320i, 325i, 325td (Long Stud) (Excl. M-series)	91-92			†	70587	L	Gas Ryder	⊖	61248	↔	Gas Ryder	4270	4269
					†	70588	R	Gas Ryder	⊖	61248	↔	Gas Ryder		
3 Series	E36 Series (Excl. M3)	91-99			†	55834	L	Gas Ryder	⊖	61248	↔	Gas Ryder	4270	4269
					†	55835	R	Gas Ryder	⊖	61248	↔	Gas Ryder		
3 Series	E36 Series (Imported 4 cyl. models)	91-99							⊖	61248	↔	Gas Ryder	4270	4269
									⊖	61248	↔	Gas Ryder		
3 Series	E36 Series (Imported 6 cyl. models)	91-99							⊖	61248	↔	Gas Ryder	4270	4269
									⊖	61248	↔	Gas Ryder		
3 Series	E36 Cabriolet	93-99			†	55834	L	Gas Ryder	⊖	61248	↔	Gas Ryder		
					†	55835	R	Gas Ryder	⊖	61248	↔	Gas Ryder		
3 Series	E46 Series (Excl. M3, + Touring) one pin at the bottom strut mounting	99-05		24	†	70508	L	Gas Ryder	⊖	61248	↔	Gas Ryder		
					†	70509	R	Gas Ryder	⊖	61248	↔	Gas Ryder		
3 Series	E90 Series (Excl. M3,)	05-12			†	70577	L	Gas Ryder	†	69102	↔	Gas Ryder		
					†	70578	R	Gas Ryder	†	69102	↔	Gas Ryder		
3 Series	E91 Series	05-12							†	69102	↔	Gas Ryder		
									†	69102	↔	Gas Ryder		



BMW

VEHICLE LISTING

Shocks, Struts, Gaslifts & Cartridges – Passenger

B

Model	Derivative	Year	Vehicle Type	Fitment Guide# (pg 6)	FRONT				Rear				GASLIFT	
					Shock Info	Part #	L/R	Range	Shock Info	Part #	L/R	Range	Front	Rear
BMW (CONT...)														
3 Series	E92 Series	07-14			⚡	70789	R	Gas Ryder	⊕	69102	↔	Gas Ryder		
					⚡	70790	L	Gas Ryder	⊕	69102	↔	Gas Ryder		
3 Series	E93 Series	07 on			⚡	70577	R	Gas Ryder	⊕	69102	↔	Gas Ryder		
					⚡	70578	R	Gas Ryder	⊕	69102	↔	Gas Ryder		
5 Series	E12 Series	74-76			/	44601	↔	Gas Ryder						
5 Series	E12 Series	76-85		18	/	44601	↔	Gas Ryder	⚡	51309	↔	Technomatic		
5 Series	E28 Series (Excl. M5)	85-89		14	/	61914	↔	Gas Ryder	⚡	62352	↔	Gas Ryder		
5 Series	E34 Series (Excl. , M5)	89-96		14	/	61302	↔	Gas Ryder	⚡	62353	↔	Gas Ryder		
5 Series	E39 Series (520i, 523i, 525i, 525TDS, 528i, 530i, 530D) (Excl.)	96-04			⚡	G35228	↔	Gas Ryder	⚡	G51216	↔	Gas Ryder		
5 Series	E39 Series (535i, 540i) (Excl.)	96-04			⚡	G35227	↔	Gas Ryder	⚡	G51216	↔	Gas Ryder		
5 Series	E60 Series	04-10			⚡	70815	R	Gas Ryder	⊕	69121	↔	Gas Ryder		
					⚡	70814	L	Gas Ryder	⊕	69121	↔	Gas Ryder		
7 Series	E23 Series (Excl.)	77-86		18					⚡	62351	↔	Gas Ryder	4061	
7 Series	E32 Series	87-94			/	61302	↔	Gas Ryder					4060	
X3	E83 2.5i, 3.0i, 2.0d and 3.0d	04-10			⚡	70642	L	Gas Ryder	⊕	62021	↔	Gas Ryder		
					⚡	70643	R	Gas Ryder	⊕	62021	↔	Gas Ryder		
X5	E53 3.0i, 3.0d, 4.4iV8, 4.8 V8 4X4	01-07			⚡	70542	L	Gas Ryder	⊕	61292	↔	Gas Ryder		
					⚡	70543	R	Gas Ryder	⊕	61292	↔	Gas Ryder		
Z3	E36/4 (E36/7 roadster) (E36/8 coupé)	98-03							⊕	69948	↔	Gas Ryder		
									⊕	69948	↔	Gas Ryder		
CAM														
Inyathi	Minibus	07 on			⊕	G56244	↔	Safari	⊕	G56245	↔	Safari		
CHANA														
Star	Bakkie, Panel Van, Minibus (Incl. Maxi Star)	06 on			⚡	35953	L	Technomatic	⊕	G45896	↔	Technomatic		
					⚡	35954	R	Technomatic	⊕	G45896	↔	Technomatic		
CHERY														
QQ3	0.8, 1.1 (S11)	08 on			⚡	35955	L	Technomatic	⊕	36875	↔	Technomatic		
					⚡	35956	R	Technomatic	⊕	36875	↔	Technomatic		
Tiggo	All	08 on			⚡	70628	L	Gas Ryder						
					⚡	70629	R	Gas Ryder						

VEHICLE LISTING

Shocks, Struts, Gaslifts & Cartridges – Passenger

CHEVROLET

















































C

Model	Derivative	Year	Vehicle Type	Fitment Guide# (pg 6)	FRONT				Rear				GASLIFT	
					Shock Info	Part #	L/R	Range	Shock Info	Part #	L/R	Range	Front	Rear
CHEVROLET														
2500, 3800, 4100	2.5, 3.8, & 4.1 Estate	75-78			⊥	G45212	↔	Technomatic	⊕	G45399	↔	Technomatic		
2500, 3800, 4100	2.5, 3.8, & 4.1 Sedan	72-78			⊥	G45212	↔	Technomatic	⊕	G45489	↔	Technomatic		
Aveo	T200 (Kalos) Hatch Gen 1	02-11			⚡	35941	L	Technomatic	⊕	36866	↔	Technomatic		
					⚡	35942	R	Technomatic	⊕	36866	↔	Technomatic		
C Series	C10, C20	63-73			⊕	G56106	↔	Safari	⊕	G56107	↔	Safari		
C Series	C10, C20	74-83			⊕	G56106	↔	Safari						
C Series	C30	63-73			⊕	G56106	↔	Safari	⊕	G56126	↔	Safari		
C Series	C30	74-83			⊕	G56106	↔	Safari						
Chevelle	Mk I	64-70			⊥	G45466	↔	Technomatic						
Cruze	(J300) Gen 2	09 on			⚡	70706	L	Gas Ryder	⊕	62052	↔	Gas Ryder		
					⚡	70707	R	Gas Ryder	⊕	62052	↔	Gas Ryder		
El Camino	Incl. El Toro	71-72			⊥	G45255	↔	Technomatic	⊕	G56118	↔	Safari		
					⊥	G45255	↔	Technomatic	⊕	G45533	↔	Technomatic		
El Camino	Incl. El Toro	72-78			⊥	G45532	↔	Technomatic	⊕	G45534	↔	Technomatic		
Firenza	Coupe	71-78		2	⊕	G45447	↔	Technomatic	⊕	G45533	↔	Technomatic		
Luv	Faster	73-78			⊕	G45535	↔	Technomatic	⊕	G56116	↔	Safari		
					⊕	G45535	↔	Technomatic	⊕	G45006	↔	Technomatic		
Nomad	LDV	75-78			⊕	G45447	↔	Technomatic						
Optra (Lacetti)	1.6 & 1.8 (Mk I)	02 on			⚡	70563	L	Gas Ryder	⚡	70566	L	Gas Ryder		
					⚡	70564	R	Gas Ryder	⚡	70565	R	Gas Ryder		
Spark	M200, M250	06-10			⚡	70800	L	Gas Ryder	⊕	62089	↔	Gas Ryder		
					⚡	70801	R	Gas Ryder	⊕	62089	↔	Gas Ryder		
Spark	M300 (Excl. Lite)	10 on			⚡	70596	L	Gas Ryder	⊕	G45897	↔	Technomatic		
					⚡	70597	R	Gas Ryder	⊕	G45897	↔	Technomatic		
Spark (Matiz)	Spark (M100, M150)	03-05			⚡	G35295	L	Gas Ryder	⊕	69431	↔	Gas Ryder		
					⚡	G35300	R	Gas Ryder	⊕	69431	↔	Gas Ryder		
Utility	Montana LDV	11 on			⚡	70757	↔	Gas Ryder	⊕	G56278	↔	Safari		
CHEVROLET/OPEL														
Ascona, Chevair	(C)	82-85			⚡	44615	↔	Technomatic	⊕	G45839	↔	Technomatic		4080
Ascona, Chevair	(Short strut) (C)	84-86							⊕	G45839	↔	Technomatic		4080
Ascona, Chevair	B, (Mk I Cavalier)	76-82							⊕	G45489	↔	Technomatic		



C

Model	Derivative	Year	Vehicle Type	Fitment Guide# (pg 6)	FRONT				Rear				GASLIFT	
					Shock Info	Part #	L/R	Range	Shock Info	Part #	L/R	Range	Front	Rear
CHRYSLER														
Voyager	Gen I (Incl. Grand Voyager) (Excl. )	86-95							☉	G63690	↔	Gas Ryder		
Voyager	Gen II (Incl. Grand Voyager) (Excl. )	95-00				G55697	↔	Gas Ryder	☉	G63690	↔	Gas Ryder		
Voyager	Gen III (Incl. Grand Voyager) (Excl. )	01-07							☉	G63690	↔	Gas Ryder		
CITROEN														
Xsara	Mk 2 (Incl. Picasso Excl. VTS) (1.4, 1.6, 2.0, 2.0HDI)	00-07							☉	69965	↔	Gas Ryder		
DAEWOO														
Cielo	Nexia	95-98		14		61909	↔	Gas Ryder	☉	G45874	↔	Technomatic		
						44607	↔	Technomatic	☉	G45874	↔	Technomatic		
Espero	Aranos	95-99		14		61909	↔	Gas Ryder	☉	G45874	↔	Technomatic		
						44607	↔	Technomatic	☉	G45874	↔	Technomatic		
Lanos	Sens	97-03		14		61909	↔	Gas Ryder	☉	G45874	↔	Technomatic		
						44607	↔	Technomatic	☉	G45874	↔	Technomatic		
Matiz	Spark (M100)	99-03				G35295	L	Gas Ryder	☉	69431	↔	Gas Ryder		
						G35300	R	Gas Ryder	☉	69431	↔	Gas Ryder		
DAIHATSU														
Charade	Incl. Coupe (G11)	83-87							☉	G45861	↔	Technomatic		
Sirion	1.3, 1.5 (Mk II) (Boon)	05-10				70700	↔	Gas Ryder	☉	62040	↔	Gas Ryder		
Terios II	4X2, 4X4	6/06 on			☉	70695	↔	Gas Ryder	☉	62038	↔	Gas Ryder		
DODGE (CHRYSLER)														
Dodge	Caliber	06 on				70711	L	Gas Ryder		69117	↔	Gas Ryder		
						70712	R	Gas Ryder		69117	↔	Gas Ryder		
Dodge Husky	LDV	74-78		3					☉	G45006	↔	Technomatic		
FIAT														
124	Station Wagon	69-77							☉	G45006	↔	Technomatic		
125	Sedan	69-75							☉	G45423	↔	Technomatic		
132	1.6GL, 1.6GLS, 1.8GLS (Argenta)	79-81							☉	G45810	↔	Technomatic		
Palio	Expresso Panel Van	02 on				70583	↔	Gas Ryder	☉	62005	↔	Gas Ryder		
Palio	Type 1X	00-01				G35214	↔	Gas Ryder	☉	61270	↔	Gas Ryder		
Palio	Type 2H	02 on				70583	↔	Gas Ryder	☉	62005	↔	Gas Ryder		
Palio	Weekend (Type 2G)	02 on							☉	69919	↔	Gas Ryder		
Palio	Weekend (Type PY)	00-01				G35214	↔	Gas Ryder	☉	69919	↔	Gas Ryder		
Punto	Mk II	04-12				70710	↔	Gas Ryder						
Seicento	600	99-03				G35279	↔	Gas Ryder	☉	69921	↔	Gas Ryder		

VEHICLE LISTING

Shocks, Struts, Gaslifts & Cartridges – Passenger

FIAT



F

Model	Derivative	Year	Vehicle Type	Fitment Guide# (pg 6)	FRONT				Rear				GASLIFT	
					Shock Info	Part #	L/R	Range	Shock Info	Part #	L/R	Range	Front	Rear
FIAT (CONT...)														
Siena	Siena II	02 on							⊖	61270	↔	Gas Ryder		
Siena	Type 2A	00-02			⚡	G35214	↔	Gas Ryder	⊖	61270	↔	Gas Ryder		
Strada	3/4 ton LDV (Mk II)	05 on			⚡	70594	↔	Gas Ryder	⊖	G56258	↔	Safari		
Uno	Incl. Turbo (Series 2)	90-06			⚡	55854	↔	Gas Ryder	⊖	61241	↔	Gas Ryder		4063
Uno	Panel Van (Series 2)	90-06			⚡	55854	↔	Gas Ryder	⊖	61241	↔	Gas Ryder		
FORD														
Bantam	1.3	83-86			⚡	35816	↔	Technomatic	⊖	G45875	↔	Technomatic		
Bantam	1.6	83-86			⚡	35816	↔	Technomatic	⊖	G45875	↔	Technomatic		
Bantam	1.4	86-94			⚡	35844	↔	Technomatic	⊖	G45875	↔	Technomatic		
Bantam	1.6	86-94			⚡	35844	↔	Technomatic	⊖	G45875	↔	Technomatic		
Bantam	1.3	94-02			⚡	35927	↔	Technomatic	⊖	G45878	↔	Technomatic		
Bantam	1.6	94-02			⚡	35927	↔	Technomatic	⊖	G45878	↔	Technomatic		
Bantam	1.8D	02			⚡	70510	↔	Gas Ryder	⊖	G45878	↔	Technomatic		
Bantam	1.3	03-06			⚡	70510	↔	Gas Ryder	⊖	G45878	↔	Technomatic		
Bantam	1.6	03-06			⚡	70510	↔	Gas Ryder	⊖	G45878	↔	Technomatic		
Bantam	1.3	06 on			⚡	70510	↔	Gas Ryder	⊖	G45878	↔	Technomatic		
Bantam	1.6	06 on			⚡	70510	↔	Gas Ryder	⊖	G45878	↔	Technomatic		
Capri	Mk I	69-73			⚡	44516	↔	Technomatic	⊖	36854	↔	Technomatic		
Corsair	1.6	64-66							⊖	36854	↔	Technomatic		
Corsair	1.6, 2.0	66-69							⊖	36854	↔	Technomatic		
Cortina	Mk I	64-66							⊖	36854	↔	Technomatic		
Cortina	Mk II	67							⊖	36854	↔	Technomatic		
Cortina	Mk II	68-70							⊖	36854	↔	Technomatic		
Cortina	Mk III	71-77			⊖	G45503	↔	Technomatic	⊖	G45520	↔	Technomatic		
Cortina	Mk III, IV	71-78		20	⊖	G56153	↔	Safari	⊖	G45418	↔	Technomatic		
Cortina	Mk III, IV LDV	71-78		20	⊖	G56153	↔	Safari	⊖	G56103	↔	Safari		
Cortina	Mk IV	77-80			⊖	G45503	↔	Technomatic	⊖	G45520	↔	Technomatic		
Cortina	Mk IV LDV	78-80			⊖	G56153	↔	Safari	⊖	G56156	↔	Safari		
Cortina	Mk V Estate	80-83			⊖	G45837	↔	Technomatic	⊖	G45520	↔	Technomatic		
Cortina	Mk V LDV	80-82			⊖	G56160	↔	Safari	⊖	G56156	↔	Safari		
Cortina	Mk V LDV	83-86			⊖	G56160	↔	Safari	⊖	G56159	↔	Safari		
Cortina	Mk V Sedan	80-83		14	⊖	G45837	↔	Technomatic	⊖	G45838	↔	Technomatic		
Courier	4X2 (Standard Susp.)	86-06			⊖	G56173	↔	Safari	⊖	G56116	↔	Safari		
					⊖	G45871	↔	Technomatic	⊖	G45872	↔	Technomatic		
Courier	4X4, 4X2 Hi-Trail (Raised Susp.)	86-06			⊖	G556233	↔	Safari HDP	⊖	G578014	↔	Safari HDP		
					⊖	G56169	↔	Safari	⊖	G56170	↔	Safari		



FORD

VEHICLE LISTING

Shocks, Struts, Gaslifts & Cartridges – Passenger

F

Model	Derivative	Year	Vehicle Type	Fitment Guide# (pg 6)	FRONT				Rear				GASLIFT	
					Shock Info	Part #	L/R	Range	Shock Info	Part #	L/R	Range	Front	Rear
FORD (CONT...)														
Escort	Mk I	68-73			/	44505	↔	Technomatic	⊖	G45413	↔	Technomatic		
Escort	Mk I 1100, 1300	70-75			/	44505	↔	Technomatic	⊖	G45413	↔	Technomatic		
Escort	Mk I 1600, GT	70-75			/	44516	↔	Technomatic	⊖	G45413	↔	Technomatic		
Escort	Mk I, II	74-81			/	44505	↔	Technomatic	⊖	G45413	↔	Technomatic		
Escort	Mk II	75-81		17	/	44505	↔	Technomatic	⊖	G45742	↔	Technomatic		
Escort	Mk III Fwd L, GL, GLE	81-86			/	35816	↔	Technomatic	/	55802	↔	Gas Ryder		4063
					/	35816	↔	Technomatic	/	35817	↔	Technomatic		
Escort	Mk III Fwd XR3, Sport	81-86			/	35816	↔	Technomatic	/	55802	↔	Gas Ryder		4064
					/	35816	↔	Technomatic	/	35817	↔	Technomatic		
Escort	Mk V, VI, VII	95-99			/	G35146	↔	Gas Ryder	/	G51082	↔	Gas Ryder		
					/	G35146	↔	Gas Ryder	⊖	69423	↔	Gas Ryder		4272
Everest	4X2 & 4X4	09-15			⊖	G56222	↔	Safari						
F Series	F100	65-67			†	G56119	↔	Safari	⊖	G56102	↔	Safari		
F Series	F100	68-69			⊖	G56123	↔	Safari	⊖	G56102	↔	Safari		
F Series	F100	70-81		5	⊖	G56123	↔	Safari	⊖	G56118	↔	Safari		
F Series	F250 4X2	65-67			†	G56119	↔	Safari	⊖	G56102	↔	Safari		
F Series	F250 4X2	68-69			⊖	G56123	↔	Safari	⊖	G56102	↔	Safari		
F Series	F250 4X2	70-81		5	⊖	G56123	↔	Safari	⊖	G56118	↔	Safari		
F Series	F250 4X4	68-77			†	G45667	↔	Technomatic						
F Series	F250 4X4	78-81							⊖	G56155	↔	Safari		
F Series	F350	67-81			⊖	G56123	↔	Safari	⊖	G56102	↔	Safari		
Fiesta	Mk IV (Excl. 1.6 RSi 3-door) (Sleeve eye) (Facelift)	99-03		22	/	55865	↔	Gas Ryder	/	69095	↔	Gas Ryder		4063
Fiesta	Mk IV (Excl. 1.6 RSi 3-door) (U Bracket)	97-99		23	/	55865	↔	Gas Ryder	/	69082	↔	Gas Ryder		
Fiesta	Mk V Hatch & Sedan	04-08			/	70567	L	Gas Ryder	⊖	61299	↔	Gas Ryder		4322
					/	70568	R	Gas Ryder	⊖	61299	↔	Gas Ryder		
Fiesta	Mk VI	08 on			/	70600	L	Gas Ryder	⊖	62009	↔	Gas Ryder		
					/	70601	R	Gas Ryder	⊖	62009	↔	Gas Ryder		
Figo	1.4	10 on			/	70567	L	Gas Ryder	⊖	61299	↔	Gas Ryder		
					/	70568	R	Gas Ryder	⊖	61299	↔	Gas Ryder		
Focus	Mk I Hatch & Sedan	98-04			/	G35296	L	Gas Ryder	⊖	69422	↔	Gas Ryder		4316
					/	G35307	R	Gas Ryder	⊖	69422	↔	Gas Ryder		
Focus	Mk II Hatch & Sedan (Excl. 2.5 RS & ST)	04-11			/	70584	L	Gas Ryder	⊖	G45894	↔	Technomatic		
					/	70585	R	Gas Ryder	⊖	G45894	↔	Technomatic		
Focus	Mk III Hatch & Sedan (Excl. 2.5 ST & RS)	11 on			/	70771	L	Gas Ryder	⊖	62073	↔	Gas Ryder		
					/	70772	R	Gas Ryder	⊖	62073	↔	Gas Ryder		

VEHICLE LISTING

Shocks, Struts, Gaslifts & Cartridges – Passenger

FORD



F

Model	Derivative	Year	Vehicle Type	Fitment Guide# (pg 6)	FRONT				Rear				GASLIFT	
					Shock Info	Part #	L/R	Range	Shock Info	Part #	L/R	Range	Front	Rear
FORD (CONT...)														
Granada	Mk I, Mk II	72-86			☐	G45503	↔	Technomatic	⊥	G45651	↔	Technomatic		
Husky	Minibus, LDV, Panel Van	85-98			⊥	G56185	↔	Safari	☉	G56102	↔	Safari		
					⊥	G45466	↔	Technomatic	☉	G45051	↔	Technomatic		
Ikon	(B3)	00-06		22	⚡	55865	↔	Gas Ryder	⚡	69095	↔	Gas Ryder		
Ikon	Mk V Hatch & Sedan	07 on			⚡	70567	L	Gas Ryder	☉	61299	↔	Gas Ryder		
					⚡	70568	R	Gas Ryder	☉	61299	↔	Gas Ryder		
Ka	1.3 (Mk I)	05-09			⚡	G35326	↔	Gas Ryder	⚡	G51275	↔	Gas Ryder		
Laser, Meteor, Tracer	Familia	69-76							⊥	G45078	↔	Technomatic		
									⊥	G45078	↔	Technomatic		
Laser, Meteor, Tracer	KC/KE, GC	86-91			⚡	35832	↔	Technomatic	⚡	55804	↔	Gas Ryder		4087
					⚡	35832	↔	Technomatic	⚡	35833	↔	Technomatic		
Laser, Meteor, Tracer	KF/KH	91-01			⚡	55825	↔	Gas Ryder	⚡	55804	↔	Gas Ryder		4087
					⚡	35848	↔	Technomatic	⚡	35833	↔	Technomatic		
Mondeo	Mk II	96-01			⚡	G35189	↔	Gas Ryder	⚡	G35112	↔	Gas Ryder		
Mondeo	Mk II (Excl. self levelling)	96-01			⚡	G35189	↔	Gas Ryder						
Ranchero	Falcon	69-76							⊥	G56105	↔	Safari		
									⊥	G45078	↔	Technomatic		
Ranger	4X2 (Standard Susp.)	86-06			☉	G56173	↔	Safari	☉	G56116	↔	Safari		
					☉	G45871	↔	Technomatic	☉	G45872	↔	Technomatic		
Ranger	4X4, 4X2 Hi-Trail (Raised Susp.)	86-06			☉	GS56233	↔	Safari HDP	☉	GS78014	↔	Safari HDP		
					☉	G56169	↔	Safari	☉	G56170	↔	Safari		
Ranger	4X2 (Standard Susp.)	07-12			☉	G56235	↔	Safari	☉	G56228	↔	Safari		
Ranger	4X4, 4X2 Hi-Trail (Raised Susp.)	07-12			☉	GS56233	↔	Safari HDP	☉	GS78014	↔	Safari HDP		
					☉	G56222	↔	Safari	☉	G56223	↔	Safari		
Ranger	4X2 (Standard Susp.)	12-15			⚡	G56290	↔	Safari	☉	G56291	↔	Safari		
Ranger	4X4, 4X2 Hi-Trail (Raised Susp.) T6	12-15			⚡	GS46013	↔	Safari HDP	☉	GS78032	↔	Safari HDP		
					⚡	G56276	↔	Safari	☉	G56277	↔	Safari		
Sapphire	1.6, 2.0, 2.3, 3.0 (Incl. XR6, Excl. XR8 & Estate)	83-93			⚡	35842	↔	Technomatic	☉	G45860	↔	Technomatic		
Sierra	1.6, 2.0, 2.3, 3.0 (Incl. XR6, Excl. XR8 & Estate)	83-93			⚡	35842	↔	Technomatic	☉	G45860	↔	Technomatic		4080
Sierra	1.6, 2.0, 2.3, 3.0 Estate	83-93			⚡	35842	↔	Technomatic	⊥	G45858	↔	Technomatic		4080
Spectron	Minibus, Van	91-03			⊥	G45876	↔	Technomatic	☉	G56186	↔	Safari		4131
					⊥	G45876	↔	Technomatic	☉	G45870	↔	Technomatic		
Taurus	17M, 20M	61-73		19					☉	G45423	↔	Technomatic		
Telstar	Incl. TX5	93-99			⚡	55843	L	Gas Ryder	⚡	55845	↔	Gas Ryder		4502
					⚡	55844	R	Gas Ryder	⚡	55845	↔	Gas Ryder		
Triton	0510, 0610	85-87			☉	55088	↔	Safari	☉	G56102	↔	Safari		
					☉	55211	↔	Safari						



G

Model	Derivative	Year	Vehicle Type	Fitment Guide# (pg 6)	FRONT				Rear				GASLIFT	
					Shock Info	Part #	L/R	Range	Shock Info	Part #	L/R	Range	Front	Rear
GWM														
GWM	2.2, 2.8TDi (4X2)	07 on			⊥	G45862	↔	Technomatic	⊗	G45870	↔	Technomatic		
Steed	4X2	08 on			⊥	G45904	↔	Technomatic	⊗	G45905	↔	Technomatic		
Steed 5	4X2	08 on							⊗	G45905	↔	Technomatic		
HILLMAN														
Vogue, Hunter	Incl. Sceptre, Arrow	67-77							⊗	36854	↔	Technomatic		
Vogue, Hunter	Safari	67-77							⊗	G45051	↔	Technomatic		
HONDA														
Ballade	Mk II	82-84			⊥	35830	↔	Technomatic						
Ballade	Mk III 130, 150, 150i (SC9) (Civic)	84-88		14	⊥	55810	↔	Gas Ryder	⊥	69067	↔	Gas Ryder		
Ballade	Mk IV 150, 160i (SH4) (Civic)	89-92			⊥	69075	↔	Gas Ryder	⊥	69076	↔	Gas Ryder		
Ballade	Mk IV 160i (SH4) (Civic)	87-89		14					⊥	69067	↔	Gas Ryder		
Ballade	Mk V 150, 160i (SR4) (Civic)	92-96			⊥	69079	↔	Gas Ryder	⊥	69076	↔	Gas Ryder		
Ballade	Mk VI 150i, 160i, 180i Excl. Vtech (Civic)	96-01			⊥	69084	↔	Gas Ryder	⊥	G55910	↔	Gas Ryder		
Civic	Mk VI	96-01			⊥	69084	↔	Gas Ryder	⊥	G55910	↔	Gas Ryder		4289
Civic	Mk VII Hatch	01-05			⊥	70648	L	Gas Ryder	⊥	G51298	↔	Gas Ryder		
					⊥	70649	R	Gas Ryder	⊥	G51298	↔	Gas Ryder		
Civic	Mk VII Sedan	01-05			⊥	70648	L	Gas Ryder	⊥	G51298	↔	Gas Ryder		
					⊥	70649	R	Gas Ryder	⊥	G51298	↔	Gas Ryder		
Civic	Mk VIII Sedan	06-11			⊥	70598	L	Gas Ryder	⊗	62011	↔	Gas Ryder		
					⊥	70599	R	Gas Ryder	⊗	62011	↔	Gas Ryder		
CR-V	Mk II 4X4 2.0, 2.2D (RD4, RD5, RD6, RD7)	02 on			⊥	70612	L	Gas Ryder	⊗	69104	↔	Gas Ryder		
					⊥	70613	R	Gas Ryder	⊗	69104	↔	Gas Ryder		
CR-V	Mk III RD6	07-12			⊥	70718	L	Gas Ryder	⊥	69120	↔	Gas Ryder		
					⊥	70719	R	Gas Ryder	⊥	69120	↔	Gas Ryder		
CR-V	RD1-RD3	95-01			⊥	G51255	↔	Gas Ryder	⊥	G51256	↔	Gas Ryder		
Fit	Gen 1 (GD1)	07 on			⊥	70749	L	Gas Ryder	⊗	61296	↔	Gas Ryder		
					⊥	70750	R	Gas Ryder	⊗	61296	↔	Gas Ryder		
Jazz	1.4Dsi, 1.5 Gen 1 (Fit)	03-07			⊥	70610	L	Gas Ryder	⊗	61296	↔	Gas Ryder		
					⊥	70611	R	Gas Ryder	⊗	61296	↔	Gas Ryder		
Jazz	Gen 2 (Fit)	08-13			⊥	70715	L	Gas Ryder	⊥	62058	↔	Gas Ryder		
					⊥	70716	R	Gas Ryder	⊥	62058	↔	Gas Ryder		
Odyssey	RA1-RA5	97-99			⊥	G55877	↔	Gas Ryder	⊥	G55821	↔	Gas Ryder		
Prelude	Coupe	83-87			⊥	G55723	↔	Gas Ryder						
Prelude	Coupe (Sealed struts Rear)	83-87			⊥	G55723	↔	Gas Ryder						

VEHICLE LISTING

Shocks, Struts, Gaslifts & Cartridges – Passenger

HYUNDAI



H

Model	Derivative	Year	Vehicle Type	Fitment Guide# (pg 6)	FRONT				Rear				GASLIFT	
					Shock Info	Part #	L/R	Range	Shock Info	Part #	L/R	Range	Front	Rear
HYUNDAI														
Accent	LC (Mk II)	00-05			⚡	70624	L	Gas Ryder	⚡	55870	↔	Gas Ryder		
					⚡	70625	R	Gas Ryder	⚡	55870	↔	Gas Ryder		
Accent	MC. 1.6 (Mk3)	05-11			⚡	G54023	L	Gas Ryder	⊖	62016	↔	Gas Ryder		
					⚡	G54024	R	Gas Ryder	⊖	62016	↔	Gas Ryder		
Accent	Mk IV	11 on			⚡	70810	L	Gas Ryder	⊖	62093	↔	Gas Ryder		
					⚡	70811	R	Gas Ryder	⊖	62093	↔	Gas Ryder		
Accent	X3	94-97			⚡	55869	↔	Gas Ryder	⚡	55868	↔	Gas Ryder		
Accent	X3	98-00			⚡	55869	↔	Gas Ryder	⚡	55870	↔	Gas Ryder		
Atoz	Incl. Prime (Mk II)	99 on			⚡	35951	L	Technomatic	⊖	69412	↔	Gas Ryder		
					⚡	35952	R	Technomatic	⊖	36867	↔	Technomatic		
Atoz	Mk I	97-98							⊖	69412	↔	Gas Ryder		
									⊖	69412	↔	Gas Ryder		
Elantra	HD Sedan	06-10			⚡	70793	L	Gas Ryder	⊖	62085	↔	Gas Ryder		
					⚡	70794	R	Gas Ryder	⊖	62085	↔	Gas Ryder		
Elantra	J1 Series (Avante)	91-96			⚡	G55592	↔	Gas Ryder	⚡	G51059	↔	Gas Ryder		
Elantra	J2 & J3 Series (Avante)	96-00			⚡	70519	L	Gas Ryder	⚡	70544	L	Gas Ryder		
					⚡	70520	R	Gas Ryder	⚡	70545	R	Gas Ryder		
Elantra	XD (J4) (Avante)	00-06			⚡	70519	L	Gas Ryder	⚡	70521	L	Gas Ryder		
					⚡	70520	R	Gas Ryder	⚡	70522	R	Gas Ryder		
Getz	3 & 5-door	03 on			⚡	70548	L	Gas Ryder	⊖	61285	↔	Gas Ryder		
					⚡	70549	R	Gas Ryder	⊖	61285	↔	Gas Ryder		
H100	Bakkie, minibus, van	96-05			⊖	G56176	↔	Safari	⊖	G56102	↔	Safari		
					⊖	G45535	↔	Technomatic	⊖	G45051	↔	Technomatic		
i10	Hatch	08 on			⚡	70569	L	Gas Ryder	⊖	62053	↔	Gas Ryder		
					⚡	70570	R	Gas Ryder	⊖	62053	↔	Gas Ryder		
i20	Hatch (Pre-Facelift)	09-13			⚡	70696	L	Gas Ryder	⊖	62086	↔	Gas Ryder		
					⚡	70697	R	Gas Ryder	⊖	62086	↔	Gas Ryder		
iX35	4X2 (Excl. AWD)	10 on			⚡	70691	L	Gas Ryder	⊖	62036	↔	Gas Ryder		
					⚡	70692	R	Gas Ryder	⊖	62036	↔	Gas Ryder		
Matrix	(Lavita) Mini MPV	02 on			⚡	70550	L	Gas Ryder	⚡	70530	L	Gas Ryder		
					⚡	70551	R	Gas Ryder	⚡	70531	R	Gas Ryder		



H

Model	Derivative	Year	Vehicle Type	Fitment Guide# (pg 6)	FRONT				Rear				GASLIFT	
					Shock Info	Part #	L/R	Range	Shock Info	Part #	L/R	Range	Front	Rear
HYUNDAI (CONT...)														
Santa Fe	SM (Mk I)	01-06			↙	70554	L	Gas Ryder	⊖	61289	↔	Gas Ryder		
					↘	70555	R	Gas Ryder	⊖	61289	↔	Gas Ryder		
Sonata	EF (Mk IV)	09.98-03.01			↘	69099	↔	Gas Ryder						
Sonata	EF (Mk IV)	03.01-02.05			↘	69099	↔	Gas Ryder	↘	69100	↔	Gas Ryder		
Sonata	Y3 (Mk III)	95-98			↘	G55673	↔	Gas Ryder	↘	G51186	↔	Gas Ryder		
Terracan	2.9, 3.5	01-09			⊖	61287	↔	Gas Ryder	⊖	61288	↔	Gas Ryder		
Tiburon	RD & RD2	96-01			↘	70519	L	Gas Ryder						
					↘	70520	R	Gas Ryder						
Tucson	All	04-11			↘	70637	L	Gas Ryder	↘	70635	L	Gas Ryder		
					↘	70638	R	Gas Ryder	↘	70636	R	Gas Ryder		
ISUZU														
Frontier	4X4, 4X2	98-02			⊖	G56173	↔	Safari	⊖	55088	↔	Safari		
KB (D-Max), TF Series	(Mk I)	78-80			⊖	G56176	↔	Safari	⊖	G56116	↔	Safari		
					⊖	G45535	↔	Technomatic	⊖	G45006	↔	Technomatic		
KB (D-Max), TF Series	4X2 (Mk II)	80-88			⊖	G45893	↔	Technomatic	⊖	G56186	↔	Safari		
					⊖	G45844	↔	Technomatic	⊖	G45870	↔	Technomatic		
KB (D-Max), TF Series	4X4 (Mk II)	80-88			⊖	G56176	↔	Safari	⊖	G56186	↔	Safari		
					⊖	G45535	↔	Technomatic	⊖	G45870	↔	Technomatic		
KB (D-Max), TF Series	4X2 (Standard Height) (TF)	89-04			⊖	G45893	↔	Technomatic	⊖	G56103	↔	Safari		
					⊖	G45844	↔	Technomatic	⊖	G45008	↔	Technomatic		
KB (D-Max), TF Series	4X4, 4X2 (Raised Height) (TF)	89-04			⊖	G45871	↔	Technomatic	⊖	G45008	↔	Technomatic		
					⊖	G56173	↔	Safari	⊖	G56103	↔	Safari		
					⊖	G556225	↔	Safari HDP	⊖	G578006	↔	Safari HDP		
KB (D-Max), TF Series	4X2 (Standard Height) (P190) (Mk V)	04-13 (Q1)			↘	G56212	↔	Safari	⊖	G56213	↔	Safari		
KB (D-Max), TF Series	4X4, 4X2 (Raised Height) (P190) (Mk V)	04-13 (Q1)			⊖	G556225	↔	Safari HDP	⊖	G578006	↔	Safari HDP		
					⊖	G56214	↔	Safari	⊖	G56215	↔	Safari		
KB (D-Max), TF Series	4X2, 4X4 (Raised Height) (Mk VI)	13 on			↘	G546014	↔	Safari HDP	⊖	G578038	↔	Safari HDP		
WFR, Relay	Fargo	80-95			⊖	G56185	↔	Safari	⊖	G45006	↔	Technomatic		4129

VEHICLE LISTING

Shocks, Struts, Gaslifts & Cartridges – Passenger

IVECO



Model	Derivative	Year	Vehicle Type	Fitment Guide# (pg 6)	FRONT				Rear				GASLIFT		
					Shock Info	Part #	L/R	Range	Shock Info	Part #	L/R	Range	Front	Rear	
IVECO															
Daily	Panel Van 107Kw D (50C15, 65C15, 70C15)	04 on			☉	76208	↔	Fleet Ryder	☉	76209	↔	Fleet Ryder			
Daily	Panel Van 92Kw D (35S13, 50C13)	01-08			☉	76208	↔	Fleet Ryder	☉	76209	↔	Fleet Ryder			
Daily, Turbo Daily	35.10V, 45.10, A45.10, 40.10, 49.12, 59.12	95-00			☉	42772	↔	Technomatic	☉	42773	↔	Technomatic			
Daily, Turbo Daily	45.10, A45.10, 49.10	95-00			☉	42772	↔	Technomatic	☉	42772	↔	Technomatic			
Daily, Turbo Daily	49.10, 49.12, 59.12	...			☉	42772	↔	Technomatic	☉	42772	↔	Technomatic			
Turbo Daily	42.12, 45.12, 54.12, 66.12	...							☉	42773	↔	Technomatic			
JAGUAR															
Jaguar	Mk II	61-69		1	⊖	G45535	↔	Technomatic	⊕	G56119	↔	Safari			
Jaguar	Mk X, 420, 420G, S Type (4 shocks at Rear)	65-72		1	⊖	G45535	↔	Technomatic							
Jaguar	XJ6, XJ12 (4 shocks at Rear) (Series 1, 2 and 3)	70-87			⊖	69677	↔	Gas Ryder							
JEEP (CHRYSLER)															
Jeep	Cherokee (KJ) 2.5D, 2.8D, 3.7	01-07				⚡	G546011	↔	Safari HDP	☉	G556267	↔	Safari HDP		
						⚡	G56262	↔	Safari	☉	G56263	↔	Safari		
Jeep	Cherokee (XJ)	96-01				⊖	G578025	↔	Safari HDP	☉	G556261	↔	Safari HDP		
Jeep	CJ Series (Willys) (CJ5, CJ6, CJ7)	54-86				☉	G56102	↔	Safari	☉	G56116	↔	Safari		
						☉	G45051	↔	Technomatic	☉	G45006	↔	Technomatic		
Jeep	Patriot (Mk)	07 on				⚡	70711	L	Gas Ryder	⚡	69117	↔	Gas Ryder		
						⚡	70712	R	Gas Ryder	⚡	69117	↔	Gas Ryder		
Jeep	Wrangler 4X4 (JK) Incl. Rubicon	07-on				⊖	G556288	↔	Safari HDP	☉	G556289	↔	Safari HDP		
Jeep	Wrangler 4X4 (TJ)	96-06				⊖	G578025	↔	Safari HDP	☉	G578026	↔	Safari HDP		
						⊖	G63721	↔	Gas Ryder	☉	G63722	↔	Gas Ryder		
KIA															
Cerato	Hatch & Sedan	09-13				⚡	70795	L	Gas Ryder	☉	62086	↔	Gas Ryder		
						⚡	70796	R	Gas Ryder	☉	62086	↔	Gas Ryder		
Clarus	2.0 GLX (Credos)	98-06				⚡	35943	L	Technomatic	⚡	35945	L	Technomatic		
						⚡	35944	R	Technomatic	⚡	35946	R	Technomatic		
K2700	Bongo (Gen 3)	00-04				⊖	G56178	↔	Safari	☉	G56103	↔	Safari		
K2700	Bongo (Gen 4)	05 on				⊖	G56251	↔	Safari	☉	G56252	↔	Safari		
Picanto	Mk 1 Incl. '07 & '10 facelift (SA)	04-11				⚡	70569	L	Gas Ryder	⊖	62000	↔	Gas Ryder		
						⚡	70570	R	Gas Ryder	⊖	62000	↔	Gas Ryder		
Picanto	Mk 2 (TA)	11 on								⊖	62084	↔	Gas Ryder		
										⊖	62084	↔	Gas Ryder		



KIA

VEHICLE LISTING

Shocks, Struts, Gaslifts & Cartridges – Passenger

K

Model	Derivative	Year	Vehicle Type	Fitment Guide# (pg 6)	FRONT				Rear				GASLIFT		
					Shock Info	Part #	L/R	Range	Shock Info	Part #	L/R	Range	Front	Rear	
KIA (CONT...)															
Pregio	Bongo	00-04			⊥	G56178	↔	Safari							
Rio	1.3 & 1.6 (DC)	00-03							⊖	61295	↔	Gas Ryder			
Rio	1.3 & 1.6 (DC)	03-06				⌋	70620	L	Gas Ryder	⊖	62015	↔	Gas Ryder		
								R	Gas Ryder	⊖	62015	↔	Gas Ryder		
Rio	Rio 1.4 & 1.6 Gen2 (JB)	06-11				⌋	G54023	L	Gas Ryder	⊖	62016	↔	Gas Ryder		
								R	Gas Ryder	⊖	62016	↔	Gas Ryder		
Sorento	2.5D & 3.5 (Mk I)	02-06				⌋	G45898	L	Technomatic	⊖	G56266	↔	Safari		
								R	Technomatic	⊖	G56266	↔	Safari		
Sorento	2.5D & 3.8 (Mk II)	07-09				⌋	G45898	L	Technomatic						
								R	Technomatic						
Sportage	2.0, 2.0D (Mk I)	93-04							⊖	G63720	↔	Gas Ryder			
Sportage	2.0, 2.7, 2.0D (Mk II)	04-10				⌋	70637	L	Gas Ryder	⌋	70635	L	Gas Ryder		
								R	Gas Ryder	⌋	70636	R	Gas Ryder		
Sportage	4X2 2.0, 2.4 – Gen2 (Excl. AWD)	10 on				⌋	70691	L	Gas Ryder	⊖	62036	↔	Gas Ryder		
								R	Gas Ryder	⊖	62036	↔	Gas Ryder		
LADA															
Niva	VAZ-2121	87-92		16	⊖	G45893	↔	Technomatic	⊖	G56102	↔	Safari			
LAND ROVER															
Defender	109 WB, Series I	54-65			⊖	G56112	↔	Safari	⊖	G56126	↔	Safari			
Defender	109 WB, Series II, III	65-84			⊖	G56112	↔	Safari	⊖	G56113	↔	Safari			
Defender	109, 110 WB forward control	65-83			⊖	G56162	↔	Safari	⊖	G56163	↔	Safari			
Defender	88 WB	54-80			⊖	G56112	↔	Safari	⊖	G56126	↔	Safari			
Defender	90, 110, 130 (Incl. County & LDV)	95 on			⊥	G578007	↔	Safari HDP	⊖	G578039	↔	Safari HDP			
Defender	90, 110, 130 (Incl. County & LDV)	84-94			⊥	G578007	↔	Safari HDP	⊖	G578008	↔	Safari HDP			
Defender	90, 110, 130 (Incl. County & LDV)	84 on			⊥	G56164	↔	Safari	⊖	G56165	↔	Safari			
Discovery	Series I	89-98				⊥	G578007	↔	Safari HDP	⊖	G578008	↔	Safari HDP		
								↔	Safari	⊖	G56165	↔	Safari		
Discovery	Series II. 4.0 V8, 2.5TD5	98-04				⊖	G578029	↔	Safari HDP	⊖	G578030	↔	Safari HDP		
								↔	Safari	⊖	G56247	↔	Safari		
Freelander	Mk I (1.8, 2.0Td4, 2.5 V6)	98-3/07				⌋	70614	L	Gas Ryder	⌋	70616	L	Gas Ryder		
								R	Gas Ryder	⌋	70617	R	Gas Ryder		
Range Rover	Air Susp. (Mk I)	92-96			⊥	G56180	↔	Safari	⊖	G56165	↔	Safari			
Range Rover	Excl. air Susp. (Mk I)	70-96				⊥	G578007	↔	Safari HDP	⊖	G578008	↔	Safari HDP	4205	
								↔	Safari	⊖	G56165	↔	Safari	4205	
MAHINDRA															
Bolero	4X4	05 on			⊖	61282	↔	Technomatic	⊖	61281	↔	Technomatic			
Scorpio	4X2	05 on				⊥	61283	↔	Technomatic	⊖	G45886	↔	Technomatic		
								↔	Technomatic	⊖	G45886	↔	Technomatic		
Scorpio	4X4, 4X2 Raised. (Mk I) 2.2, 2.4D	06 on				⊖	G556264	↔	Safari HDP	⊖	G556265	↔	Safari HDP		
								↔	Safari	⊖	G56204	↔	Safari		

VEHICLE LISTING

Shocks, Struts, Gaslifts & Cartridges – Passenger

MAZDA



M

Model	Derivative	Year	Vehicle Type	Fitment Guide# (pg 6)	FRONT				Rear				GASLIFT	
					Shock Info	Part #	L/R	Range	Shock Info	Part #	L/R	Range	Front	Rear
MAZDA														
323	(BD) Incl. S (non Sealed strut)	81-83		21		35832	↔	Technomatic		35833	↔	Technomatic		
323	(BF) Incl. S, Egi, Sport	82-91				55803	↔	Gas Ryder		55804	↔	Gas Ryder		4087
						35832	↔	Technomatic		35833	↔	Technomatic		
323	(Familia) Incl. Midge & Sting	91-04				55825	↔	Gas Ryder		55804	↔	Gas Ryder		
						35848	↔	Technomatic		35833	↔	Technomatic		
323	RWD (Imported strut)	77-78							⊖	G45810	↔	Technomatic		
323	RWD (local strut)	78-81			/	44535	↔	Technomatic	⊖	G45810	↔	Technomatic		
626	1.8, 2.0 (Mk V), Y5 Sedan	99-03				70654	L	Gas Ryder		70656	L	Gas Ryder		4271
						70655	R	Gas Ryder		70657	R	Gas Ryder		
626	2.0, 2.5 (Incl. MX-6) (Mk IV)	92-98				55843	L	Gas Ryder		55845	↔	Gas Ryder		4071
						55844	R	Gas Ryder		55845	↔	Gas Ryder		
626	Incl. Coupe (Mk II, Mk III) (GC & GD)	83-92				55806	↔	Gas Ryder		55807	↔	Gas Ryder		
626	Zimbabwe model	87-91				G55600	↔	Gas Ryder		G55601	↔	Gas Ryder		
1200, 1300	Familia (Mk II)	72-75							⊕	G45078	↔	Technomatic		
B Series, Drifter, Magnum	4X2 Standard Susp.	86-07			⊖	G56173	↔	Safari	⊖	G56116	↔	Safari		
					⊖	G45871	↔	Technomatic	⊖	G45872	↔	Technomatic		
B Series, Drifter, Magnum	Mk II, III & IV	64-86			⊕	G45212	↔	Technomatic	⊕	G56105	↔	Safari		
					⊕	G45212	↔	Technomatic	⊕	G45078	↔	Technomatic		
B Series, Drifter, Magnum	4X4, 4X2 Hi-Trail (Raised Susp.)	86-07			⊖	G556233	↔	Safari HDP	⊖	G578014	↔	Safari HDP		
					⊖	G56169	↔	Safari	⊖	G56170	↔	Safari		
BT-50	4X2 Standard Susp.	07-12			⊖	G56235	↔	Safari	⊖	G56228	↔	Safari		
BT-50	4X4, 4X2 Raised Susp.	07-12			⊖	G556233	↔	Safari HDP	⊖	G578014	↔	Safari HDP		
					⊖	G56222	↔	Safari	⊖	G56223	↔	Safari		
BT-50	4X2 Standard Susp.	12-15				G56290	↔	Safari	⊖	G56291	↔	Safari		
BT-50	4X4, 4X2 Raised Susp.	12-15				G546013	↔	Safari HDP	⊖	G578032	↔	Safari HDP		
						G56276	↔	Safari	⊖	G56277	↔	Safari		
Demio	Hatch DY	03 on				70816	L	Gas Ryder	⊖	61299	↔	Gas Ryder		
						70817	R	Gas Ryder	⊖	61299	↔	Gas Ryder		
E2000, E2700, E3000	LDV	66-83			⊕	G45667	↔	Technomatic	⊕	G56105	↔	Safari		
					⊕	G45667	↔	Technomatic	⊕	G45078	↔	Technomatic		
E2000, E3000	LDV	67-81			⊕	G45667	↔	Technomatic	⊕	G45078	↔	Technomatic		
Etude	1.6 L (BJ) (Familia)	10/02-04				55888	L	Gas Ryder		55890	L	Gas Ryder		
						55889	R	Gas Ryder		55891	R	Gas Ryder		
Etude	1.6 L (BJ) (Familia)	00-09/02								55890	L	Gas Ryder		
										55891	R	Gas Ryder		
F1000, F1300	LDV	81-86			⊕	G45523	↔	Technomatic	⊕	G56105	↔	Safari		
					⊕	G45523	↔	Technomatic	⊕	G45078	↔	Technomatic		



M

Model	Derivative	Year	Vehicle Type	Fitment Guide# (pg 6)	FRONT				Rear				GASLIFT	
					Shock Info	Part #	L/R	Range	Shock Info	Part #	L/R	Range	Front	Rear
MAZDA (CONT...)														
Familia	BJ	00-04			↙	70741	L	Gas Ryder	↙	70743	L	Gas Ryder		
					↘	70742	R	Gas Ryder	↘	70744	R	Gas Ryder		
Familia	BJE	99-00			↙	70745	L	Gas Ryder	↙	70747	L	Gas Ryder		
					↘	70746	R	Gas Ryder	↘	70748	R	Gas Ryder		
Marathon (Ford Husky)	Van, Bus	92-03			⊥	G45876	↔	Technomatic	⊕	G56186	↔	Safari		4131
					⊥	G45876	↔	Technomatic	⊕	G45870	↔	Technomatic		
Mazda 2	Hatch DE (Demio)	07 on			↙	70600	L	Gas Ryder	⊕	62009	↔	Gas Ryder		
					↘	70601	R	Gas Ryder	⊕	62009	↔	Gas Ryder		
Mazda 3	1.6, 2.0 Excl. 2.3 MPS (Mk I) (BK) (Axela)	04-09			↙	70592	L	Gas Ryder	⊕	G45892	↔	Technomatic		
					↘	70593	R	Gas Ryder	⊕	G45892	↔	Technomatic		
Mazda 6	All Excl. MPS (GG/GY)	03 on			↙	69107	L	Gas Ryder						
					↘	69108	R	Gas Ryder						
Rustler	130, 160	85-86			↙	35816	↔	Technomatic	⊕	G45875	↔	Technomatic		
Rustler	1400, 1600	86-94			↙	35844	↔	Technomatic	⊕	G45875	↔	Technomatic		
Rustler	1300, 1600	94-02			↙	35927	↔	Technomatic	⊕	G45878	↔	Technomatic		
Soho	121 (Sleeved-Eye)	99-06		22	↙	55865	↔	Gas Ryder	↘	69095	↔	Gas Ryder		4063
Soho	121 (U-Bracket)	97-99		23	↙	55865	↔	Gas Ryder	↘	69082	↔	Gas Ryder		
T2000, T3000	LDV, Truck	81-86			⊕	55211	↔	Safari	⊕	G56177	↔	Safari		
T2000, T3000	LDV, Truck	83 on			⊕	55211	↔	Safari	⊕	G56177	↔	Safari		
MERCEDES-BENZ														
114, 115 Series	220, 230, 240D, 280E, 280 (Excl.)	68-77			⊕	61201	↔	Gas Ryder	⊥	55208	↔	Safari		
A Class	(W168) A160, A190, 170CDI	00-04			↙	G35365	↔	Gas Ryder	⊕	69444	↔	Gas Ryder		
A Class	A170, A180Cdi, A200 (W169)	05-12			↙	70659	↔	Gas Ryder	⊕	62030	↔	Gas Ryder		
B Class	(W245) B150, B160, B170, B200, B180 Cdi, B200 Cdi	05-11							⊕	62030	↔	Gas Ryder		
C Class	200, 230E, 240D, 250, 280E, 300D (Excl.) (W123)	77-86			⊕	61202	↔	Gas Ryder	⊥	55208	↔	Safari		
C Class	190 Series (Excl.) (W201)	83-94			↙	55815	↔	Gas Ryder	⊕	69744	↔	Gas Ryder		
C Class	200, 230E, 260E, 300D, 300E (Excl.) (W124)	86-95			↙	55815	↔	Gas Ryder	⊕	69744	↔	Gas Ryder		
C Class	C180, C200, C220, C230, C250 (Excl. C280 & Sport Susp.) (W202)	94-00			⊕	61253	↔	Gas Ryder	⊕	61254	↔	Gas Ryder		
C Class	C280 (W202)	94-00							⊕	61254	↔	Gas Ryder		
C Class	C180, C200, C220CDi, C230, C270CDi, C280, C320CDi, C350 (W203)	00-07			↙	70602	↔	Gas Ryder	⊕	62004	↔	Gas Ryder		
C Class	(CLC 203)	00-11			↙	70808	↔	Gas Ryder	⊕	62092	↔	Gas Ryder		
C Class	C180, C200, C220CDi, C230, C270CDi, C280, C320CDi, C350 (W203)	07 on							⊕	62032	↔	Gas Ryder		
C Class	C180, C200, C220CDi, C230, C250, C250CDi, C300, C320CDi, C350 (W204) (Excl. S/W; AMG; Elec. & Air Susp.)	07-14							⊕	62032	↔	Gas Ryder		

VEHICLE LISTING

Shocks, Struts, Gaslifts & Cartridges – Passenger

MERCEDES-BENZ



M

Model	Derivative	Year	Vehicle Type	Fitment Guide# (pg 6)	FRONT				Rear				GASLIFT		
					Shock Info	Part #	L/R	Range	Shock Info	Part #	L/R	Range	Front	Rear	
MERCEDES-BENZ (CONT...)															
E Class	E230, E250D (W210)	95-99			⊥	69952	↔	Gas Ryder							
E Class	E200, E220D, E280, E280TD, E290TD (Excl. ,) (W210)	95-02			⊥	69952	↔	Gas Ryder	⊥	69966	↔	Gas Ryder			
E Class	E200K, E220 Cdi, E240, E270Cdi, E280, E320Cdi, E350, E500, E320 (Excl. Station Wagon, AMG, Elec. & Air Susp.)	02-09							⊥	62013	↔	Gas Ryder			
E Class	(W212) Excl. Coupe, AMG, (Excl.)	09-15			⌋	70786	↔	Gas Ryder	⊥	62083	↔	Gas Ryder			
S Class	220, 250, 280 (W111 Series)	60-68							⊥	36761	↔	Technomatic			
S Class	190, 200, 230 (W110 Series)	62-67							⊥	36761	↔	Technomatic			
S Class	W108 Series	68-73							⊥	36761	↔	Technomatic			
S Class	280SE, 280S, 350SE (Excl.) (W116 Series)	73-81			⊥	61202	↔	Gas Ryder	⊥	55208	↔	Safari			
S Class	280SE, 300SE, 380SE, 420SE, 500SE, 560SE Incl. SEL & SEC (Excl.) (W126)	81-93			⊥	61202	↔	Gas Ryder	⊥	55208	↔	Safari			
SL Class	280 SL, SLC, 350 SL, SLC (Excl.)	71-81			⊥	61201	↔	Gas Ryder							
SL Class	450 SL, SLC (Excl.)	73-81			⊥	61201	↔	Gas Ryder							
Sprinter	308D (903) Cargo van	95-06							⊖	42864	↔	Technomatic			
Sprinter	308D, 312D (903) Passenger van	95-06							⊖	42864	↔	Technomatic			
Sprinter	312D Panel Van (body length 319.5mm)	95-06							⊖	42864	↔	Technomatic			
									⊖	42864	↔	Technomatic			
Sprinter	412D (903) Cargo van	95-06							⊖	83450	↔	Heavy Duty			
Sprinter	412D (903) Passenger van	95-06							⊖	83450	↔	Heavy Duty			
Sprinter	Panel Van	06 on			⌋	70506	↔	Gas Ryder	⊖	62008	↔	Gas Ryder			
Unimog	414, 416	...			⊖	76014	↔	Fleet Ryder	⊖	76014	↔	Fleet Ryder			
Vito	112 CDI 2.2 Cr-Cab Panel Van Diesel (W638)	03-04			⌋	70538	↔	Gas Ryder	⊖	61294	↔	Gas Ryder			
Vito	112 CDI 2.2 Panel Van Diesel (W638)	02-04			⌋	70538	↔	Gas Ryder	⊖	61294	↔	Gas Ryder			
Vito	115 CDI 2.2 Bus MPV Diesel (W639)	04 on							⊖	G56268	↔	Safari			
Vito	115 CDI 2.2 Cr-Cab Panel Van Diesel (W639)	04 on							⊖	G56268	↔	Safari			
Vito	115 CDI 2.2 Panel Van Diesel (W639)	04 on							⊖	G56268	↔	Safari			
W110 Series	190, 200, 230	62-67							⊥	36761	↔	Technomatic			
W111 Series	220, 250, 280	60-68							⊥	36761	↔	Technomatic			



MINI

VEHICLE LISTING

Shocks, Struts, Gaslifts & Cartridges – Passenger

M

Model	Derivative	Year	Vehicle Type	Fitment Guide# (pg 6)	FRONT				Rear				GASLIFT	
					Shock Info	Part #	L/R	Range	Shock Info	Part #	L/R	Range	Front	Rear
MINI														
Cooper	One, Cooper & Cooper S (R50, R53)	02-06			†	70679	L	Gas Ryder	†	69109	↔	Gas Ryder		
Cooper	One, Cooper & Cooper S (R50, R53)	02-06			†	70680	R	Gas Ryder	†	69109	↔	Gas Ryder		
MITSUBISHI														
Colt	Galant Mk III (Imported strut)	77-78							⊕	G45812	↔	Technomatic		
Colt	Galant Mk III (local strut)	78-83			†	44612	↔	Technomatic	⊕	G45812	↔	Technomatic		
Colt Bakkie	L200 (1.6, 2.0, 2.5D 4X2)	94-98			⊥	G56185	↔	Technomatic	⊕	G56116	↔	Safari		
Colt Bakkie	L200 (2.6, 3.0, V6 4X4, 4X2 Raised height)	94-98			⊥	G556234	↔	Safari HDP	⊕	G578016	↔	Safari HDP		
Colt Bakkie	L200 (2.6, 3.0, V6 4X4, 4X2 Raised height)	94-98			⊥	G56185	↔	Safari	⊕	G56184	↔	Safari		
Colt Bakkie	L200 (4X2 Raised height)	98-07			⊕	G556220	↔	Safari HDP	⊕	G578003	↔	Safari HDP		
Colt Bakkie	L200 (4X2 Raised height)	98-07			⊕	G56172	↔	Safari	⊕	G56184	↔	Safari		
Colt Bakkie	L200 (4X2 Raised height)	98-07			⊕	G45893	↔	Technomatic	⊕	G56184	↔	Safari		
Colt Bakkie	L200 (4X2 Standard height)	98-07			⊥	G56185	↔	Technomatic	⊕	G56116	↔	Safari		
Colt Bakkie	L200 (4X2 Standard height)	98-07			⊥	G56185	↔	Technomatic	⊕	G45872	↔	Technomatic		
Colt Bakkie	L200 (4X4)	98-07			⊕	G556220	↔	Safari HDP	⊕	G578003	↔	Safari HDP		
Colt Bakkie	L200 (4X4)	98-07			⊕	G56241	↔	Safari	⊕	G56184	↔	Safari		
Colt Bakkie	L200 (4X4)	98-07			⊕	G56172	↔	Safari	⊕	G56184	↔	Safari		
L300 (Delica)	Incl. Starwagon, Express	82-03			⊥	G56185	↔	Safari	⊕	G56102	↔	Safari		
L300 (Delica)	Incl. Starwagon, Express	82-03			⊥	G45466	↔	Technomatic	⊕	G45051	↔	Technomatic		
Pajero	3.0, 3.8, 3.2 Di-D (Mk IV NS, SWB & LWB)	07 on			†	G546006	↔	Safari HDP	⊕	G578020	↔	Safari HDP		
					†	G56237	↔	Safari	⊕	G56274	↔	Safari		
Pajero	4X4 3.2 Di-D & 3.8 (Mk III) (SWB & LWB)	99-07			†	G546006	↔	Safari HDP	⊕	G578020	↔	Safari HDP		
					†	G56237	↔	Safari	⊕	G56274	↔	Safari		
Pajero	V Series (Mk II)	91-99			⊕	G556220	↔	Safari HDP	⊕	G578019	↔	Safari HDP		
					⊕	46004	↔	Safari	⊕	46005	↔	Safari		
Pajero	Sport Gen2 (Challenger)	09 on			†	G56205	↔	Safari	⊕	G56269	↔	Safari		
Tredia	Excl. Turbo	83-86			†	35836	↔	Technomatic	⊕	G45824	↔	Technomatic		
Tredia	Turbo	83-86							⊕	G45824	↔	Technomatic		
Triton	4X4, 4X2 Raised height	07 on			†	G546009	↔	Safari HDP	⊕	G578021	↔	Safari HDP		
					†	G56205	↔	Safari	⊕	G56210	↔	Safari		

VEHICLE LISTING

Shocks, Struts, Gaslifts & Cartridges – Passenger

NISSAN



N

Model	Derivative	Year	Vehicle Type	Fitment Guide# (pg 6)	FRONT				Rear				GASLIFT	
					Shock Info	Part #	L/R	Range	Shock Info	Part #	L/R	Range	Front	Rear
NISSAN														
1 Ton Bakkie	620, 680, 1300, 1500	66-80			⊖	G56171	↔	Safari	⊕	G56157	↔	Safari		
					⊖	G45842	↔	Technomatic	⊕	G45432	↔	Technomatic		
1 Ton Bakkie	720 4X2	80-88			⊖	G56171	↔	Safari	⊖	G56102	↔	Safari		
					⊖	G45842	↔	Technomatic	⊖	G45051	↔	Technomatic		
1 Ton Bakkie	Hardbody 4X2 (Excl. Hi Rider) (D21)	88-02			⊖	G45893	↔	Technomatic	⊖	G56116	↔	Safari		
					⊖	G45869	↔	Technomatic	⊖	G45872	↔	Technomatic		
1 Ton Bakkie	Hardbody 4X2 Hi Rider Incl. Sani (D21)	88-02			⊖	G45893	↔	Technomatic	⊖	G56116	↔	Safari		
					⊖	G45893	↔	Technomatic	⊖	G45872	↔	Technomatic		
1 Ton Bakkie	Hardbody 4X4 (Incl. Sani, Patrol) (D21)	88-02			⊖	G56171	↔	Safari	⊖	G56116	↔	Safari		
					⊖	G56171	↔	Safari	⊖	G45872	↔	Technomatic		
1 Ton Bakkie	Hardbody 4X4 (D22)	98 on			⊖	G556221	↔	Safari HDP	⊖	G578018	↔	Safari HDP		
					⊖	G56171	↔	Safari	⊖	G56190	↔	Safari		
1 Ton Bakkie	Hardbody 4X2 (Excl. Hi Rider) (D22)	02 on			⊖	G45893	↔	Technomatic	⊖	G56190	↔	Safari		
					⊖	G45869	↔	Technomatic	⊖	G56190	↔	Safari		
1 Ton Bakkie	Hardbody 4X4, 4X2 Hi Rider (D22)	02 on			⊖	G556221	↔	Safari HDP	⊖	G578018	↔	Safari HDP		
					⊖	G56171	↔	Safari	⊖	G56190	↔	Safari		
1/2 Ton Bakkie	1400,1200, 120Y	71-09			/	44217	↔	Technomatic	⊖	G45051	↔	Technomatic		
1/2 Ton Bakkie	120Y (12" wheels)	76-83			/	44217	↔	Technomatic	⊖	G45051	↔	Technomatic		
1/2 Ton Bakkie	1400 (13" wheels)	80-83			/	44510	↔	Technomatic	⊖	G45051	↔	Technomatic		
Almera	Excl. ABS (N16)	01-07			/	70500	L	Gas Ryder	/	69093	↔	Gas Ryder		
					/	70501	R	Gas Ryder	/	69093	↔	Gas Ryder		
E20 (Urvan, Caravan)	Ekonowagon, Ekonovan (Urvan, Caravan)	73-81			⊖	G45122	↔	Technomatic	⊕	G56157	↔	Safari	4162	
					⊖	G45122	↔	Technomatic	⊕	G45432	↔	Technomatic		
E20 (Urvan, Caravan)	Ekonowagon, Ekonovan (Urvan, Caravan)	81-95			⊖	G56176	↔	Safari	⊕	G56157	↔	Safari		
					⊖	G45535	↔	Technomatic	⊕	G45432	↔	Technomatic		
Juke	(F15) All	11 on			/	70833	L	Gas Ryder		62102	↔	Gas Ryder		
					/	70834	R	Gas Ryder		62102	↔	Gas Ryder		
Langley	Incl. Panache (N10, Mk I)	80-83			/	44227	↔	Technomatic	⊖	19289	↔	Technomatic	4099	
Langley	Incl. Exa (Sealed strut) (N12, Mk II)	83-88			/	35847	↔	Technomatic	⊖	G45859	↔	Technomatic		
Laurel	2000, 2300, 2400 (C30)	68-72			⊖	G45255	↔	Technomatic	⊖	G45423	↔	Technomatic		
Laurel	240, 260, 300 (C130)	72-78		13	⊖	G45255	↔	Technomatic	⊖	G45008	↔	Technomatic		
Laurel	C230	78-87		13	/	44608	↔	Technomatic	/	69074	↔	Gas Ryder		
Livina	Incl. X-Gear & Grand Livina (XJ)	06 on			/	70589	L	Gas Ryder	⊖	62094	↔	Gas Ryder		
					/	70590	R	Gas Ryder	⊖	62094	↔	Gas Ryder		
Micra	Gen 3 5-Door (K12)	04-11			/	70575	L	Gas Ryder	⊖	62001	↔	Gas Ryder		
					/	70576	R	Gas Ryder	⊖	62001	↔	Gas Ryder		
Micra	Gen 4 (K13)	11 on			/	70806	L	Gas Ryder	⊖	62091	↔	Gas Ryder		
					/	70807	R	Gas Ryder	⊖	62091	↔	Gas Ryder		



N

Model	Derivative	Year	Vehicle Type	Fitment Guide# (pg 6)	FRONT			Rear			GASLIFT			
					Shock Info	Part #	L/R	Range	Shock Info	Part #	L/R	Range	Front	Rear
NISSAN (CONT...)														
Navara	4X4 & 4X2 (D40)	05-09			†	G546010	↔	Safari HDP	⊗	G556259	↔	Safari HDP		
					†	46003	↔	Safari	⊗	G56236	↔	Safari		
NP200	1.5, 1.6	08 on			†	70586	↔	Gas Ryder	⊕	62012	↔	Gas Ryder		
NP300	4X2 (Excl. Hi Rider) (D22)	08 on			⊕	G45893	↔	Technomatic	⊗	G56190	↔	Safari		
					⊕	G45869	↔	Technomatic	⊗	G56190	↔	Safari		
NP300	4X4 & 4X2 Hi Rider (D22)	08 on			⊕	G556221	↔	Safari HDP	⊗	G578018	↔	Safari HDP		
NP300	4X4 (D22)	08 on			⊕	G56171	↔	Safari	⊗	G56190	↔	Safari		
Pathfinder	2.5 Dci, 4.0 (Mk III R51 series)	05-12			†	G546010	↔	Safari HDP	⊗	G556260	↔	Safari HDP		
Patrol	4X4 (G160)	80-89			†	G56119	↔	Safari						
Patrol	4X4 (WG60)	72-80			†	G56119	↔	Safari	†	G56119	↔	Safari		
Patrol	Station Wagon 4X4 (Y60, Y61, Rear for Y60 only)	89-01			†	G56105	↔	Safari	⊗	G56174	↔	Safari		
Primera	P11	98-02			†	G51213	↔	Gas Ryder	†	G51214	↔	Gas Ryder		
Pulsar	(Sealed strut) (N12, Mk II)	83-88			†	35847	↔	Technomatic	⊕	G45859	↔	Technomatic		
Pulsar	Incl. Panache (N10, Mk I)	80-83			†	44227	↔	Technomatic	⊕	19289	↔	Technomatic		
Qashqai	1.6, 2.0, 1.5DCI (J10, JJ10)	07-14			†	70661	L	Gas Ryder	⊗	62026	↔	Gas Ryder		
					†	70662	R	Gas Ryder	⊗	62026	↔	Gas Ryder		
Sabre	160, 200 (Excl. ABS)	92-01			†	55838	L	Gas Ryder	†	55855	L	Gas Ryder	4515	
					†	55839	R	Gas Ryder	†	55856	R	Gas Ryder	4516	
Safari	Station Wagon (G160/G161) & Pick-Up	82-90			†	G56119	↔	Safari	⊕	G56168	↔	Safari		
Sani	4X2	90-99			⊕	G56172	↔	Safari	⊗	G56116	↔	Safari		
					⊕	G56172	↔	Safari	⊗	G45872	↔	Technomatic		
Sani	4X4	90-99			⊕	G56171	↔	Safari	⊗	G56116	↔	Safari		
					⊕	G45842	↔	Technomatic	⊗	G45872	↔	Technomatic		
Sentra	140	92-01			†	55838	L	Gas Ryder	†	55840	↔	Gas Ryder	4268	
					†	55839	R	Gas Ryder	†	55840	↔	Gas Ryder		
Sentra	160, 200 (Excl. STi)	92-01			†	55838	L	Gas Ryder	†	55855	L	Gas Ryder		
					†	55839	R	Gas Ryder	†	55856	R	Gas Ryder		
Sentra	Sedan, Coupe (B12)	87-92			†	55816	↔	Gas Ryder	†	55817	↔	Gas Ryder		
Skyline	R31	87-92		13	†	61915	↔	Gas Ryder	†	69073	↔	Gas Ryder	4068	
Skyline	1800, 2000 (R30)	82-87		13	†	44608	↔	Technomatic	†	69074	↔	Gas Ryder		
Skyline	2800 GLX, GTX (R30)	82-87		13	†	44608	↔	Technomatic	†	69073	↔	Gas Ryder		
Stanza	1600J, 1800J Stanza, Resort (A10)	78-83			†	44510	↔	Technomatic	⊕	36854	↔	Technomatic		
Stanza	1600J, 1800J, Stanza Station Wagon (A10)	79-83			†	44510	↔	Technomatic	⊗	G45006	↔	Technomatic		
Terrano II	R20 LWB	98-03			⊕	G56173	↔	Safari	⊗	G56184	↔	Safari		
Terrano II	R20 SWB	98-04			⊕	G56173	↔	Safari	⊗	G56184	↔	Safari		

VEHICLE LISTING

Shocks, Struts, Gaslifts & Cartridges – Passenger

NISSAN



N

Model	Derivative	Year	Vehicle Type	Fitment Guide# (pg 6)	FRONT				Rear				GASLIFT	
					Shock Info	Part #	L/R	Range	Shock Info	Part #	L/R	Range	Front	Rear
NISSAN (CONT...)														
Tiida	1.6i & 1.8i Hatch & Sedan	06 on				70589	L	Gas Ryder		62006	↔	Gas Ryder		
						70590	R	Gas Ryder		62006	↔	Gas Ryder		
Tracker	4X4	80-82				G56171	↔	Safari		G56168	↔	Safari		
						G45842	↔	Technomatic		G56168	↔	Safari		
Tracker	4X4 (Incl. Sani)	82-88				G56171	↔	Safari		G56186	↔	Safari		
						G45842	↔	Technomatic		G45870	↔	Technomatic		
U' Series	1600, 1800 (Incl. Coupe)	72-73				44500	↔	Technomatic		G45423	↔	Technomatic		
U' Series	160U, 180U	74-78				44500	↔	Technomatic		G45423	↔	Technomatic		
Vanette	C22	85-85		6		G45447	↔	Technomatic		G45051	↔	Technomatic		
X-Trail	4X4 & 4X2 (Mk I)	01-07				70556	L	Gas Ryder		70558	L	Gas Ryder		
						70557	R	Gas Ryder		70559	R	Gas Ryder		
X-Trail	4X4 & 4X2 (Mk II)	08 on				70663	L	Gas Ryder		62033	↔	Gas Ryder		
						70664	R	Gas Ryder		62033	↔	Gas Ryder		
Y Series	1200	71-75				44217	↔	Technomatic		36767	↔	Technomatic		
Y Series	1200 LCV	72-75				44217	↔	Technomatic		G45122	↔	Technomatic		
Y Series	120Y, 140 SDX, (12" wheels)	75-80				44217	↔	Technomatic		36767	↔	Technomatic		
Y Series	140 SDX (13" wheels), 140Y, 160Y	75-80				44510	↔	Technomatic		36767	↔	Technomatic		
Y Series	140Y, 160Y	75-80				44510	↔	Technomatic		G45051	↔	Technomatic		
Y Series	140Y, 160Y LCV	75-80				44510	↔	Technomatic		G45533	↔	Technomatic		
OPEL														
Astra	F (Sedan)	93-99		14		61918	↔	Gas Ryder		G45874	↔	Technomatic		
						44411	↔	Technomatic		G45874	↔	Technomatic		
Astra	F (Estate)	94-01		8		61918	↔	Gas Ryder		61252	↔	Gas Ryder		4221
						44411	↔	Technomatic		61252	↔	Gas Ryder		
Astra	Caravan, Excl. 2.0 OPC (G)	98-04				70505	↔	Gas Ryder		69987	↔	Gas Ryder		4308
Astra	Excl. 2.0 OPC (G) Hatch	99-03				70505	↔	Gas Ryder		G45881	↔	Technomatic		4272
Astra	Excl. 2.0 OPC (G) Sedan	99-03				70505	↔	Gas Ryder		G45881	↔	Technomatic		
Astra	(H) 1.8 & 1.9 CDTi Incl. GTC (Excl. 2.0 Turbo Sport & OPC)	04-09								62019	↔	Gas Ryder		
										62019	↔	Gas Ryder		
Commodore	C (Estate) & Sedan	78-92				44611	↔	Technomatic		G45399	↔	Technomatic		
						44611	↔	Technomatic		G45489	↔	Technomatic		
Constantia, Kommando	Brougham	69-72				G45255	↔	Technomatic		G45533	↔	Technomatic		
Constantia, Kommando	Incl., Caprice, De Ville (AQ)	72-79				G45532	↔	Technomatic		G45533	↔	Technomatic		



O

Model	Derivative	Year	Vehicle Type	Fitment Guide# (pg 6)	FRONT				Rear				GASLIFT	
					Shock Info	Part #	L/R	Range	Shock Info	Part #	L/R	Range	Front	Rear
OPEL (CONT...)														
Corsa	(B) Lite	96-02				55858	↔	Gas Ryder	⊖	61256	↔	Gas Ryder		4277
Corsa	(B) Utility	96-04				55858	↔	Gas Ryder	⊖	61257	↔	Gas Ryder		
Corsa	(B) Lite	02-07				55858	↔	Gas Ryder	⊖	61256	↔	Gas Ryder		4277
Corsa	(C) Excl. Corsa Lite	02-07				70504	↔	Gas Ryder	⊖	61256	↔	Gas Ryder		
Corsa	(B) Utility	04-12				70527	↔	Gas Ryder	⊖	G56224	↔	Safari		
Corsa	(D)	07 on				70708	L	Gas Ryder	⊖	62044	↔	Gas Ryder		
						70709	R	Gas Ryder	⊖	62044	↔	Gas Ryder		
Kadett	(B)	66-74							⊖	G45533	↔	Technomatic		4079
Kadett	(D) Estate	80-85		7		61909	↔	Gas Ryder	⊖	G45432	↔	Gas Ryder		4069
Kadett	(D) Hatch	80-85				61909	↔	Gas Ryder	⊖	G45839	↔	Technomatic		4079
Kadett	(E) T-car	85-89				61909	↔	Gas Ryder	⊖	G45839	↔	Technomatic		4260
Kadett	T-car (E)	85-89				44607	↔	Technomatic	⊖	G45839	↔	Technomatic		
Kadett	(E) T-car	89-93		14		61909	↔	Gas Ryder	⊖	G45874	↔	Technomatic		
Kadett	T-car (E)	89-93		14		44607	↔	Technomatic	⊖	G45874	↔	Technomatic		
						61918	↔	Gas Ryder	⊖	G45874	↔	Technomatic		
Kadett	Astra	93-99		14		44411	↔	Technomatic	⊖	G45874	↔	Technomatic		
						61909	↔	Gas Ryder	⊖	G45874	↔	Technomatic		
Monza	Incl. Cub	89-93		14		44607	↔	Technomatic	⊖	G45874	↔	Technomatic		
						61909	↔	Gas Ryder	⊖	G45874	↔	Technomatic		
Monza	Incl. GSi	86-89				44607	↔	Technomatic	⊖	G45839	↔	Technomatic		
						61909	↔	Gas Ryder	⊖	G45839	↔	Technomatic		
Omega	Sedan, Estate (B)	01-04				EG35115	↔	Gas Ryder						
Rekord	C	67-73			⊖	G45212	↔	Technomatic	⊖	G45533	↔	Technomatic		
Rekord	Caravan (E)	78-92				44611	↔	Technomatic	⊖	G45138	↔	Technomatic		
Rekord	Sedan (Excl. V6) (E)	78-97				44611	↔	Technomatic	⊖	G45489	↔	Technomatic		
Rekord	380i V6	91-97				44611	↔	Technomatic	⊖	61230	↔	Gas Ryder		
Senator	A	79-86				44611	↔	Technomatic	⊖	61230	↔	Gas Ryder		
Zafira	A	01-06				G35289	L	Gas Ryder	⊖	69415	↔	Gas Ryder		
						G35290	R	Gas Ryder	⊖	69415	↔	Gas Ryder		
PEUGEOT														
206	2.0 GTi	00-06				G35338	L	Gas Ryder	⊖	69446	↔	Gas Ryder		
						G35337	R	Gas Ryder	⊖	69446	↔	Gas Ryder		
206	1.4	01-06				70539	L	Gas Ryder	⊖	69401	↔	Gas Ryder		4330
						70540	R	Gas Ryder	⊖	69401	↔	Gas Ryder		
206	1.6	01-06				70539	L	Gas Ryder	⊖	69401	↔	Gas Ryder		4333
						70540	R	Gas Ryder	⊖	69401	↔	Gas Ryder		
206	CC 1.6, CC 2.0	01-07							⊖	69446	↔	Gas Ryder		
									⊖	69446	↔	Gas Ryder		
206	1.6 Estate	03-07				G35338	L	Gas Ryder	⊖	69446	↔	Gas Ryder		
						G35337	R	Gas Ryder	⊖	69446	↔	Gas Ryder		
206	1.4HDi, 2.0HDi	04-07				G35338	L	Gas Ryder	⊖	69446	↔	Gas Ryder		4330
						G35337	R	Gas Ryder	⊖	69446	↔	Gas Ryder		

VEHICLE LISTING

Shocks, Struts, Gaslifts & Cartridges – Passenger

PEUGEOT



P

Model	Derivative	Year	Vehicle Type	Fitment Guide# (pg 6)	FRONT				Rear				GASLIFT	
					Shock Info	Part #	L/R	Range	Shock Info	Part #	L/R	Range	Front	Rear
PEUGEOT (CONT...)														
207	CC 1.6 Sport 2 EU5	06 on				70763	L	Gas Ryder						
						70764	R	Gas Ryder						
207	GT 1.6 3-dr	06 on				70763	L	Gas Ryder						
						70764	R	Gas Ryder						
207	Hatch	06 on				70763	L	Gas Ryder	⊖	62046	↔	Gas Ryder		
						70764	R	Gas Ryder	⊖	62046	↔	Gas Ryder		
306	Hatchback, saloon & cabriolet (Excl. Estate)	93-02							⊖	69965	↔	Gas Ryder		
									⊖	69965	↔	Gas Ryder		
307	1.6, 2.0 (Excl. CC)	01-08				G35369	L	Gas Ryder	⊖	61286	↔	Gas Ryder		4331
						G35370	R	Gas Ryder	⊖	61286	↔	Gas Ryder		
307	Estate	02-08				G35369	L	Gas Ryder						
						G35370	R	Gas Ryder						
404	Saloon	60-78							⊕	G45258	↔	Technomatic		
404	Estate	69-78							⊖	G45470	↔	Technomatic		
406	Saloon	96-04							⊖	69926	↔	Gas Ryder		
									⊖	69926	↔	Gas Ryder		
504	Estate	74-85				44606	↔	Technomatic	⊖	G45470	↔	Technomatic		
504	GL, GLD, Ti	73-80				44604	↔	Technomatic	⊖	G45470	↔	Technomatic		
504	L, GR	76-85				44604	↔	Technomatic	⊕	G45258	↔	Technomatic		
505	Saloon	80-85				44606	↔	Technomatic	⊖	G45450	↔	Technomatic		
RAMBLER														
Hornet & Sportabout	AMC	70-76							⊕	G45258	↔	Technomatic		
RENAULT														
Clio	Clio II 1.4, 1.5dCi & 1.6 (Excl. 1.2, 1.6 Sport, 2.0 & 3.0)	00-06				70512	↔	Gas Ryder	⊖	69989	↔	Gas Ryder		4298
Clio	Clio II 1.6 16V Sport	00-06				70809	↔	Gas Ryder	⊖	69425	↔	Gas Ryder		
Clio	Clio III Hatch	06-13				70682	↔	Gas Ryder	⊖	62043	↔	Gas Ryder		
Grand Scenic	Grand Scenic II	04-09				G35451	↔	Gas Ryder						
Laguna	I (Excl. Station Wagon)	96-00				35117	↔	Technomatic						
Logan	U90	08 on				70639	↔	Gas Ryder	⊖	62025	↔	Gas Ryder		
Megane	I (Excl. Coupe)	96-03				70511	↔	Gas Ryder	⊖	69927	↔	Gas Ryder		
Megane	II Hatch (Excl. 2.0 T Sport)	04-08				G35421	↔	Gas Ryder	⊖	69538	↔	Gas Ryder		
R5	Mk I Hatchback	72-85			⊖	36850	↔	Technomatic	⊖	36851	↔	Technomatic		
R5	Mk I Panel Van	80-85			⊖	36850	↔	Technomatic	⊖	36851	↔	Technomatic		
R8, R10	Small sedan	62-70			⊖	19022	↔	Technomatic	⊖	19022	↔	Technomatic		
R9, R11	Saloon, hatchback	83-86				35824	↔	Technomatic	⊖	36851	↔	Technomatic		



R

Model	Derivative	Year	Vehicle Type	Fitment Guide# (pg 6)	FRONT				Rear				GASLIFT	
					Shock Info	Part #	L/R	Range	Shock Info	Part #	L/R	Range	Front	Rear
RENAULT (CONT...)														
Sandero	5-door hatchback	09-14				70639	↔	Gas Ryder		62025	↔	Gas Ryder		
Scenic	Scenic I (Excl. 4X4)	98-04				70511	↔	Gas Ryder		62035	↔	Gas Ryder		
Scenic	Scenic II	04-09				G35451	↔	Gas Ryder		69512	↔	Gas Ryder		
SSANGYONG														
Musso	602TDi, E230EL, E320EL	95-06				G56173	↔	Safari		55088	↔	Safari		
Musso Sport	DC Bakkie	04 on				G56173	↔	Safari						
SUZUKI														
Alto	Gen 7	09 on				70693	L	Gas Ryder		62037	↔	Gas Ryder		
						70694	R	Gas Ryder		62037	↔	Gas Ryder		
Jimny	Gen 3 – SN413/JA/JB33	98 on				G556283	↔	Safari HDP		G556284	↔	Safari HDP		
						G45901	↔	Technomatic		G45902	↔	Technomatic		
SJ410/413, Samurai	4X4, S/W	82-87				G45122	↔	Technomatic		G45054	↔	Technomatic		
SJ410/413, Samurai	4X4, S/W	87-90				G45122	↔	Technomatic						
Swift	Gen 2	08-10				70689	L	Gas Ryder		62055	↔	Gas Ryder		
						70690	R	Gas Ryder		62055	↔	Gas Ryder		
SX4	4X2	08 on				70687	L	Gas Ryder						
						70688	R	Gas Ryder						
Vitara	5 door (Excl. V6) (Mk I)	94-98				G56518	↔	Gas Ryder		G63799	↔	Gas Ryder		
TATA														
Indica	1.4 Hatch (V2) (Incl. B-Line, Excl. TDi & ABS)	04 on				35934	L	Technomatic		51168	↔	Technomatic		
						35935	R	Technomatic		51168	↔	Technomatic		
Telcoline	4X4, 4X2 Incl. Worker	04 on				55231	↔	Safari		36860	↔	Technomatic		
Xenon	3.0 4X2 & 4X4	07 on				G56249	↔	Safari		G56250	↔	Safari		
TOYOTA														
1200	LDV	78-82				44226	↔	Technomatic		19290	↔	Technomatic		
Auris	1.4 & 1.6 (330N)	07-12				70561	L	Gas Ryder		62022	↔	Gas Ryder		
						70562	R	Gas Ryder		62022	↔	Gas Ryder		
Auris	1.8 & 2.0 (330N)	07-12								62022	↔	Gas Ryder		
										62022	↔	Gas Ryder		
Avanza	1.3 & 1.5 (Xenia) Excl. ABS	06-16				70579	L	Gas Ryder		G45891	↔	Technomatic		
						70580	R	Gas Ryder		G45891	↔	Technomatic		
Avensis	Gen 2 (T250)	06-10				70701	L	Gas Ryder						
						70702	R	Gas Ryder						
Aygo	(KRB10R) All	11-15				70723	L	Gas Ryder						
						70724	R	Gas Ryder						

VEHICLE LISTING

Shocks, Struts, Gaslifts & Cartridges – Passenger

TOYOTA



T

Model	Derivative	Year	Vehicle Type	Fitment Guide# (pg 6)	FRONT				Rear				GASLIFT	
					Shock Info	Part #	L/R	Range	Shock Info	Part #	L/R	Range	Front	Rear
TOYOTA (CONT...)														
Bubble	(1NZ)	02-07				70752	L	Gas Ryder		69092	↔	Gas Ryder		
						70753	R	Gas Ryder		69092	↔	Gas Ryder		
Camry	XV10	93-97				55846	L	Gas Ryder		55848	L	Gas Ryder	4165	
						55847	R	Gas Ryder		55849	R	Gas Ryder		
Camry	(Gen 5) (SV20)	96-01				70727	L	Gas Ryder		55848	L	Gas Ryder	4165	
						70728	R	Gas Ryder		55849	R	Gas Ryder		
Camry	XV20	97-01				55886	L	Gas Ryder		55848	L	Gas Ryder		
						55887	R	Gas Ryder		55849	R	Gas Ryder		
Celica,Supra	A60 Series (Mk III)	81-85								61228	↔	Gas Ryder		
Chaser	Mk II	92-02								69123	↔	Gas Ryder		
Condor	4X2 Mk IV	00-05				G45466	↔	Technomatic		G45872	↔	Technomatic	4521 (Left) 4522 (Right)	
						G45535	↔	Technomatic		G45006	↔	Technomatic	4521 (Left) 4522 (Right)	
Conquest	FWD (E80)	85-88				55812	↔	Gas Ryder		55813	↔	Gas Ryder	4063	
Conquest	FWD (E90)	89-07				55818	↔	Gas Ryder		55819	↔	Gas Ryder	4273	
Corolla	Imported strut (E30, E40, E50, E60)	74-80		10		44614	↔	Technomatic		G45399	↔	Technomatic		
Corolla	RWD (Excl. Van, S/W) (E70)	80-85				44614	↔	Technomatic		G45841	↔	Technomatic		
Corolla	Imported strut (E30, E40, E50, E60)	82-85		10		44614	↔	Technomatic		G45399	↔	Technomatic		
Corolla	FWD (Incl. Avante) (E80)	85-89				55812	↔	Gas Ryder		55813	↔	Gas Ryder		
Corolla	FWD (E90)	89-96				55818	↔	Gas Ryder		55819	↔	Gas Ryder		
Corolla	Excluding RSi (E100)	96-02				55861	↔	Gas Ryder		55863	↔	Gas Ryder		
Corolla	RSi (E100)	96-02				55861	↔	Gas Ryder						
Corolla	NZE120/121, ZZE121	02 on								69103	↔	Gas Ryder		
Corolla	1.3, 1.4, 1.6, 1.8, & 2.0 (E120), (E130)	02-07				55892	L	Gas Ryder		69092	↔	Gas Ryder		
						55893	R	Gas Ryder		69092	↔	Gas Ryder		
Corolla	1.3, 1.4, 1.6, 1.8, & 2.0 D4D (E140, E150)	07-14				70561	L	Gas Ryder		61297	↔	Gas Ryder		
						70562	R	Gas Ryder		61297	↔	Gas Ryder		
Corolla Carri	E90	98-05				55818	↔	Gas Ryder		55819	↔	Gas Ryder	4273	
Corolla Carri	Imported strut	73-79								G45399	↔	Technomatic		
Corolla Carri	local strut (E30, E40, E50, E60)	79-89				44614	↔	Technomatic		G45399	↔	Technomatic		



T

Model	Derivative	Year	Vehicle Type	Fitment Guide# (pg 6)	FRONT			Rear			GASLIFT			
					Shock Info	Part #	L/R	Range	Shock Info	Part #	L/R	Range	Front	Rear
TOYOTA (CONT...)														
Corona	T40, T50 Series (Incl. 2000 GSL)	64-74			⊥	G45398	↔	Technomatic	⊕	G45399	↔	Technomatic		
Corona	T60, T70 Series (Mk II 1900)	69-73			⊥	G45398	↔	Technomatic	⊕	G45006	↔	Technomatic		
Corona	Mk II 2000	72-78			⊥	G45398	↔	Technomatic	⊕	G45399	↔	Technomatic		
Corona	T100 series	74-80			⊥	G45398	↔	Technomatic	⊕	G45841	↔	Technomatic		
Corona/Carina E	AT190, ST191, CT190 Sedan made in the UK	01.96-10.97			↙	70571	L	Gas Ryder						
					↘	70572	R	Gas Ryder						
Corona/Caldina	ST210, CT210 2.0 & 2.0 Diesel Sedan	01.96-12.01			↙	70571	L	Gas Ryder	↘	70573	L	Gas Ryder		
					↘	70572	R	Gas Ryder	↘	70574	R	Gas Ryder		
Corona/Carina E	ST191, CT190 2.0 & 2.0 Diesel Sedan & LB:5 Door Hatchback with Harsh Road Package	02.96-05.98			↙	70571	L	Gas Ryder						
					↘	70572	R	Gas Ryder						
Corona/Carina E	ST191 2.0 Sedan & LB:5 Door Hatchback	03.92-02.96							↘	70573	L	Gas Ryder		
								↘	70574	R	Gas Ryder			
Corona/Carina E	ST191, CT190 2.0 & 2.0 Diesel Sedan & LB:5 Door Hatchback	03.92-05.98			↙	70571	L	Gas Ryder	↘	70573	L	Gas Ryder		
					↘	70572	R	Gas Ryder	↘	70574	R	Gas Ryder		
Corona/Carina E	ST191 2.0 Station Wagon	11.92-01.96			↙	70571	L	Gas Ryder					4084	4083
					↘	70572	R	Gas Ryder						
Corona/Caldina	ST215G/W (2.0 & 2.0 Turbo 4WD GT & GTT)	12.99-09.02			↙	70571	L	Gas Ryder						
					↘	70572	R	Gas Ryder						
Cressida	X30, X32 (Imported strut) (Mk I)	77-79							⊕	61228	↔	Gas Ryder		
								⊕	G45813	↔	Technomatic			
Cressida	X35, X36 (Imported strut) (Mk I)	78-79						⊕	G45399	↔	Technomatic			
Cressida	X30, X32 (local strut) (Mk I)	79-81			↙	44613	↔	Technomatic	⊕	61228	↔	Gas Ryder		
Cressida	X35, X36 (local strut) (Mk I)	79-81			↙	44613	↔	Technomatic	⊕	G45399	↔	Technomatic		
Cressida	MX63 (Mk II)	81-93			↙	61903	↔	Gas Ryder	⊕	G45469	↔	Technomatic	4084	
					↘	44603	↔	Technomatic	⊕	G45469	↔	Technomatic		
Cressida	Non IRS+, MX63 (Mk II)	81-93			↙	61903	↔	Gas Ryder	⊕	61228	↔	Gas Ryder		
					↘	44603	↔	Technomatic	⊕	G45813	↔	Technomatic		
Cressida	With IRS+, MX73 (Mk III)	83-93			↙	61903	↔	Gas Ryder	⊕	61212	↔	Gas Ryder		
					↘	44603	↔	Technomatic	⊕	61212	↔	Gas Ryder		
FJ Cruiser	4X4 SUV	11 on			↘	G546012	↔	Safari HDP	⊕	G578037	↔	Safari HDP		
Fortuner	4X4, 4X2 Raised Susp.	06-16			↘	G546007	↔	Safari HDP	⊕	G578010	↔	Safari HDP		
					↘	G56218	↔	Safari	⊕	G56219	↔	Safari		
Harrier	SXU 10 (Gen 1)	97-03			↘	70729	L	Gas Ryder	↘	70735	L	Gas Ryder		
					↘	70730	R	Gas Ryder	↘	70736	R	Gas Ryder		
Harrier	SXU 15 (Gen 1)	97-03			↘	70729	L	Gas Ryder	↘	70737	L	Gas Ryder		
					↘	70730	R	Gas Ryder	↘	70738	R	Gas Ryder		

VEHICLE LISTING

Shocks, Struts, Gaslifts & Cartridges – Passenger

TOYOTA



T

Model	Derivative	Year	Vehicle Type	Fitment Guide# (pg 6)	FRONT				Rear				GASLIFT	
					Shock Info	Part #	L/R	Range	Shock Info	Part #	L/R	Range	Front	Rear
TOYOTA (CONT...)														
Hi-Ace	East Africa	...							☉	G56187	↔	Safari		
Hi-Ace	H10	69-84			⊥	G45466	↔	Technomatic	☉	G56102	↔	Safari		
					⊥	G45466	↔	Technomatic	☉	G45006	↔	Technomatic		
Hi-Ace	LWB (H20, H30, H40)	84-93			☉	G56241	↔	Safari	☉	G56175	↔	Safari		4163
					☉	G56172	↔	Safari	☉	G56175	↔	Safari		4163
Hi-Ace	LWB (H20, H30, H40)	84-93			☉	G45893	↔	Technomatic	☉	G45873	↔	Technomatic		4163
					☉	G45869	↔	Technomatic	☉	G45873	↔	Technomatic		4163
Hi-Ace	SWB (H20, H30, H40)	84-88			☉	G56241	↔	Safari	☉	G56177	↔	Safari		4163
					☉	G56172	↔	Safari	☉	G56177	↔	Safari		4163
Hi-Ace	SWB (H20, H30, H40)	84-88			☉	G45893	↔	Technomatic	☉	G45054	↔	Technomatic		4163
					☉	G45869	↔	Technomatic	☉	G45054	↔	Technomatic		4163
Hi-Ace	SWB (H50)	88-93			☉	G56241	↔	Safari	☉	G56175	↔	Safari		4163
					☉	G56172	↔	Safari	☉	G56175	↔	Safari		4163
Hi-Ace	SWB (H50)	88-93			☉	G45893	↔	Technomatic	☉	G45873	↔	Technomatic		4163
					☉	G45869	↔	Technomatic	☉	G45873	↔	Technomatic		4163
Hi-Ace	Super T (H100)	93-10			☉	G56173	↔	Safari	☉	G56175	↔	Safari		4163
Hilux	4X2	69-84			⊥	G45398	↔	Technomatic	☉	G45006	↔	Technomatic		
Hilux	4X4	79-84			☉	G56158	↔	Safari	☉	G56103	↔	Safari		
					☉	G56158	↔	Safari	☉	G45008	↔	Technomatic		
Hilux	4X2	84-98			⊥	G56178	↔	Safari	☉	G56186	↔	Safari		
					⊥	G45862	↔	Technomatic	☉	G45870	↔	Technomatic		
Hilux	4X4	84-98			☉	G578000	↔	Safari HDP	☉	G578001	↔	Safari HDP		
					☉	G56158	↔	Safari	☉	G56167	↔	Safari		
Hilux	4X2 Raised Susp.	99-05			☉	G556232	↔	Safari HDP	☉	G578004	L	Safari HDP		
					☉	G556232	↔	Safari HDP	☉	G578005	R	Safari HDP		
					☉	G56189	↔	Safari	☉	G56167	L	Safari		
					☉	G56189	↔	Safari	☉	G56174	R	Safari		
Hilux	4X2 Standard Susp.	99-05			⊥	G56178	↔	Safari	☉	G56190	↔	Safari		
					⊥	G45862	↔	Technomatic	☉	G45008	↔	Technomatic		
Hilux	4X4 Raised Susp.	99-05			☉	G556232	↔	Safari HDP	☉	G578004	L	Safari HDP		
					☉	G556232	↔	Safari HDP	☉	G578005	R	Safari HDP		
					☉	G56189	↔	Safari	☉	G56167	L	Safari		
					☉	G56189	↔	Safari	☉	G56174	R	Safari		
Hilux	4X2 Standard Susp. (Vigo)	05-16			#	G45888	L	Technomatic	☉	G56208	↔	Safari		
					#	G45889	R	Technomatic	☉	G56208	↔	Safari		
Hilux	4X2, 4X4 Raised Susp. (Vigo)	05-16			☉	G546007	↔	Safari HDP	☉	G578009	↔	Safari HDP		
					☉	G56218	↔	Safari	☉	G56207	↔	Safari		



T

Model	Derivative	Year	Vehicle Type	Fitment Guide# (pg 6)	FRONT				Rear				GASLIFT	
					Shock Info	Part #	L/R	Range	Shock Info	Part #	L/R	Range	Front	Rear
TOYOTA (CONT...)														
Ipsum	Picnic (E110) (SM10)	96-01			↙	70725	L	Gas Ryder	⊖	36876	↔	Technomatic		
					↘	70726	R	Gas Ryder	⊖	36876	↔	Technomatic		
Ipsum	Avensis Verso (E121) (ACM2)	01-06			↙	70754	L	Gas Ryder	⊖	62061	↔	Gas Ryder		
					↘	70755	R	Gas Ryder	⊖	62061	↔	Gas Ryder		
Land Cruiser	80	90-98			⊕	GS78011	↔	Safari HDP	⊖	GS78012	↔	Safari HDP		
Land Cruiser	105	99-07			⊕	GS78011	↔	Safari HDP	⊖	GS78012	↔	Safari HDP		
Land Cruiser	200	08 on			⚡	GS78033	↔	Safari HDP	⊖	GS78034	↔	Safari HDP		
Land Cruiser	100 series	90-98							⊖	G56231	↔	Safari		
Land Cruiser	70SW	07 on			⊕	GS78002	↔	Safari HDP	⊖	GS78013	↔	Safari HDP		
					⊕	GS78002	↔	Safari HDP	⊖	GS78013	↔	Safari HDP		
Land Cruiser	76SW	07 on			⊕	GS78002	↔	Safari HDP	⊖	GS78013	↔	Safari HDP		
Land Cruiser	79 series	99 on			⊕	G56239	↔	Safari	⊖	G56240	↔	Safari		
					⊕	GS78002	↔	Safari HDP	⊖	GS78013	↔	Safari HDP		
Land Cruiser	80	90-98			⊕	GS78011	↔	Safari HDP	⊖	GS78012	↔	Safari HDP		
Land Cruiser	DLX, BJ75	85-99			⊖	G56179	↔	Safari	⊖	G56174	↔	Safari		
Land Cruiser	FJ45, BJ45	71-85			⊖	G56177	↔	Safari	⊖	G56186	↔	Safari		
					⊖	G45051	↔	Technomatic	⊖	G45008	↔	Technomatic		
Land Cruiser	FJ62, BJ60 S/W	83-89			⊖	G56166	↔	Safari	⊖	G56186	↔	Safari		
Land Cruiser	HDJ100, UZJ100 (Excl. air Susp.)	98-02			⊖	83455	↔	Heavy Duty	⊖	83456	↔	Heavy Duty		
									⊖	83456	↔	Heavy Duty		
Land Cruiser	HZJ70	89-99			⊖	G56179	↔	Safari	⊖	G56167	↔	Safari		
Land Cruiser	HZJ80 S/W, HZJ105 S/W	90-98			⊕	G56230	↔	Safari	⊖	G56231	↔	Safari		
Land Cruiser	Pick-Up	99 on			⊕	GS78002	↔	Safari HDP	⊖	GS78013	↔	Safari HDP		
Prado	90 SWB & 95 LWB	96-02			⚡	GS46008	↔	Safari HDP	⊖	GS78015	↔	Safari HDP		
					⚡	46001	↔	Safari	⊖	46002	↔	Safari		
Prado	90 SWB & 95 LWB	96-02			⚡	51240	↔	Technomatic	⊖	83454	↔	Heavy Duty		
Prado	120/125	02-09			⚡	GS46007	↔	Safari HDP	⊖	GS78017	↔	Safari HDP		
					⚡	G56226	↔	Safari	⊖	G56227	↔	Safari		
Prado	J150 (Excl. ⚡)	09 on			⚡	GS46012	↔	Safari HDP	⊖	GS78037	↔	Safari HDP		
					⚡	G56292	↔	Safari	⊖	G56293	↔	Safari		
Quantum	2.5 D-4D, 2.7 Minibus & Van Incl. Sesfikile (H200)	05 on			⊖	G56211	↔	Safari	⊖	G56209	↔	Safari		

VEHICLE LISTING

Shocks, Struts, Gaslifts & Cartridges – Passenger

TOYOTA



T

Model	Derivative	Year	Vehicle Type	Fitment Guide# (pg 6)	FRONT				Rear				GASLIFT	
					Shock Info	Part #	L/R	Range	Shock Info	Part #	L/R	Range	Front	Rear
TOYOTA (CONT...)														
Rav4	Serviceable front struts (XA10) Mk I	95-98			/	G44782	↔	Gas Ryder	⊖	G63940	↔	Gas Ryder		
					/	G44782	↔	Gas Ryder	⊖	36865	↔	Technomatic		
Rav4	Sealed struts (XA10) Mk I	98-00			/	70523	L	Gas Ryder	⊖	G63940	↔	Gas Ryder		
					/	70524	R	Gas Ryder	⊖	36865	↔	Technomatic		
Rav4	XA20 (Mk II)	01-06			/	70628	L	Gas Ryder	⊖	62020	↔	Gas Ryder		
					/	70629	R	Gas Ryder	⊖	62020	↔	Gas Ryder		
Rav4	XA30 (Mk III)	06 on			/	70673	L	Gas Ryder	⊖	62014	↔	Gas Ryder		
					/	70674	R	Gas Ryder	⊖	62014	↔	Gas Ryder		
RunX	E120, E130	02-07			/	55892	L	Gas Ryder	/	69092	↔	Gas Ryder		
					/	55893	R	Gas Ryder	/	69092	↔	Gas Ryder		
Spaceo	(AE114) (Mk I) (E110)	97-01			/	70731	L	Gas Ryder	⊖	70733	L	Gas Ryder		
					/	70732	R	Gas Ryder	⊖	70734	R	Gas Ryder		
Stallion	KF40	87-00			⊖	G56185	↔	Safari	⊖	G56102	↔	Safari		
					⊖	G56185	↔	Safari	⊖	G45051	↔	Technomatic		
Stout	RK 101	61-89			⊖	G45138	↔	Technomatic	⊖	G56116	↔	Safari		
					⊖	G45138	↔	Technomatic	⊖	G45006	↔	Technomatic		
Tazz	FWD (E90)	96-07			/	55818	↔	Gas Ryder	/	55819	↔	Gas Ryder	4273	
Tercel	Starlet (EL4/NL4)	90-96			/	70739	↺	Gas Ryder	/	69122	↔	Gas Ryder		
					/	70740	↻	Gas Ryder	/	69122	↔	Gas Ryder		
TUV	LDV	82-87			⊖	G45001	↔	Technomatic	⊖	G45006	↔	Technomatic		
Venture	KF40 (Minibus)	91-00			⊖	G56185	↔	Safari	⊖	G56102	↔	Safari	4199	
					⊖	G56185	↔	Safari	⊖	G45051	↔	Technomatic	4199	
Verso	1.6, 1.8, 2.0 (Mk III) (Spacio) (AR 10)	04-09			/	70618	L	Gas Ryder	⊖	69106	↔	Gas Ryder		
					/	70619	R	Gas Ryder	⊖	69106	↔	Gas Ryder		
Vigo	(CGN25) (Rear Not suitable for RSA models)	05 on			/	G56218	↔	Safari	⊖	G56281	↔	Safari		
Vigo	(LAN25) (Both Not suitable for RSA models)	05 on			/	G56282	↔	Safari	⊖	G56281	↔	Safari		
Yaris	Vitz	99-05			/	70751	↔	Gas Ryder	⊖	62060	↔	Gas Ryder		
Yaris	T1 1.0L, T3 1.3L (Mk II)	05-11			/	70608	L	Gas Ryder	⊖	G45890	↔	Technomatic		
					/	70609	R	Gas Ryder	⊖	G45890	↔	Technomatic		
Yaris	T3 1.3L (Mk II)	06-11			/	70608	L	Gas Ryder	⊖	G45890	↔	Technomatic		
					/	70609	R	Gas Ryder	⊖	G45890	↔	Technomatic		
Yaris	Hatch (Gen 3)	11 on			/	70608	L	Gas Ryder	⊖	62090	↔	Gas Ryder		
					/	70609	R	Gas Ryder	⊖	62090	↔	Gas Ryder		



T

Model	Derivative	Year	Vehicle Type	Fitment Guide# (pg 6)	FRONT				Rear				GASLIFT	
					Shock Info	Part #	L/R	Range	Shock Info	Part #	L/R	Range	Front	Rear
TRIUMPH														
Chicane	2000, 2500	65-78							+	G45078	↔	Technomatic		
VOLKSWAGEN														
1500, 1600	Type 3 car	63-69			⊖	G45417	↔	Technomatic	⊖	G45419	↔	Technomatic		
Amarok	4X4; 4X2 D/C & S/C (2+1 Trapezoidal spring)	10 on							⊖	G56255	↔	Safari		
Amarok	4X4; 4X2 D/C & S/C (3+2 Trapezoidal spring)	10 on							⊖	G56254	↔	Safari		
Beetle	Mk I	52-79		4	⊖	G45419	↔	Technomatic	⊖	G45419	↔	Technomatic		
					⊖	18727	↔	Technomatic	⊖	G45419	↔	Technomatic		
Beetle	Mk II	99-12			⌋	55872	↔	Gas Ryder	⊖	61262	↔	Gas Ryder		
Caddy	All 50mm OD strut	04 on			⌋	70546	↔	Gas Ryder	⊖	62010	↔	Gas Ryder		
Caddy	All 55mm OD strut	04 on			⌋	70560	↔	Gas Ryder	⊖	62010	↔	Gas Ryder		
Caravelle	Caravelle T4	99-04			⊖	83373	↔	Heavy Duty	⊖	83367	↔	Heavy Duty		
Citi	Incl. Chicco (Excl. Sonic, Life & VeloCiti)	84-11		9	⌋	55833	↔	Gas Ryder	⌋	69050	↔	Gas Ryder		4065
					⌋	35849	↔	Technomatic	⌋	51006	↔	Technomatic		
Citi	Sonic, Life & VeloCiti	98-11		9	⌋	55833	↔	Gas Ryder	⌋	69089	↔	Gas Ryder		4065
					⌋	35849	↔	Technomatic	⌋	69089	↔	Gas Ryder		
Citi Low. Susp.	Incl. Chicco (Excl. Sonic, Life & VeloCiti)	84-11		9	⌋	L55833	↔	Gas Ryder	⌋	L69050	↔	Gas Ryder		4065
Crafter	3 ton, 3,5 ton (Excl. 4X4 & 5 ton) (LT3)	06 on			⌋	70506	↔	Gas Ryder	⊖	62008	↔	Gas Ryder		
Fox	Incl. Shuttle	87-95		9	⌋	55833	↔	Gas Ryder	⌋	69050	↔	Gas Ryder		
					⌋	35849	↔	Technomatic	⌋	51006	↔	Technomatic		
Golf	Mk I (Imported strut)	78-79		9	⌋	35849	↔	Technomatic	⌋	69050	↔	Gas Ryder		4065
					⌋	35849	↔	Technomatic	⌋	51006	↔	Technomatic		
Golf	Mk I (local strut)	79-84		9	⌋	55833	↔	Gas Ryder	⌋	69050	↔	Gas Ryder		4065
					⌋	35849	↔	Technomatic	⌋	51006	↔	Technomatic		
					⌋	44511	↔	Technomatic	⌋	51006	↔	Technomatic		
Golf	Mk I Low. Susp.	79-84		9	⌋	L55833	↔	Gas Ryder	⌋	L69050	↔	Gas Ryder		4065
Golf	Mk II All (Excl. Cabriolet)	84-92		9	⌋	55811	↔	Gas Ryder	⌋	69068	↔	Gas Ryder		4082
Golf	Mk II Low. Susp.	84-92		9	⌋	L55811	↔	Gas Ryder	⌋	L69068	↔	Gas Ryder		4082
Golf	Mk III (Excl. VR6 & Cabriolet)	93-94		9	⌋	55811	↔	Gas Ryder	⌋	69068	↔	Gas Ryder		4082
Golf	Mk III All (Excl. cabriolet)	95-99		9	⌋	55841	↔	Gas Ryder	⌋	69068	↔	Gas Ryder		4082
Golf	Mk III GTi	94-99		9	⌋	55841	↔	Gas Ryder	⌋	69068	↔	Gas Ryder		4082
Golf	Mk III VR6	93-99		9	⌋	55841	↔	Gas Ryder	⌋	69068	↔	Gas Ryder		4082
Golf	Mk IV 1.6 (Estate)	99-04			⌋	55881	↔	Gas Ryder	⊖	G45900	↔	Technomatic		
Golf	Mk IV 1.6 (Hatch with 20mm strut rod)	99-04			⌋	55881	↔	Gas Ryder	⊖	61262	↔	Gas Ryder		4314
Golf	Mk IV 1.8, GTi, 1.9 TDi, 2.0, 2.3V5	99-04			⌋	55872	↔	Gas Ryder						

VEHICLE LISTING

Shocks, Struts, Gaslifts & Cartridges – Passenger

VOLKSWAGEN



V

Model	Derivative	Year	Vehicle Type	Fitment Guide# (pg 6)	FRONT				Rear				GASLIFT	
					Shock Info	Part #	L/R	Range	Shock Info	Part #	L/R	Range	Front	Rear
VOLKSWAGEN (CONT...)														
Golf	Mk IV 1.8, GTi, 1.9 TDi, 2.0, 2.3V5 (with 22mm strut rod)	99-04			⚡	55872	↔	Gas Ryder	⊖	61262	↔	Gas Ryder		4314
Golf	Mk IV 1.9 TDi (Estate)	99-04							⊖	645900	↔	Technomatic		
Golf	Mk V 2.0 GTi	04-09			⚡	70581	↔	Gas Ryder	⊖	62002	↔	Gas Ryder	4312	4313
Golf	Mk V 50mm Strut Body (Excl. GTi)	04-09			⚡	70546	↔	Gas Ryder	⊖	61293	↔	Gas Ryder	4312	4313
Golf	Mk V 55mm Strut Body (Excl. GTi)	04-09			⚡	70560	↔	Gas Ryder	⊖	61293	↔	Gas Ryder	4312	4313
Golf	Mk VI 50mm Strut Body (Excl. GTi)	09 on			⚡	70546	↔	Gas Ryder	⊖	61293	↔	Gas Ryder		
Golf	Mk VI 55mm Strut Body (Excl. GTi)	09 on			⚡	70560	↔	Gas Ryder	⊖	61293	↔	Gas Ryder		
Golf	Pick-Up (Caddy I) (Sealed strut)	93 on			⚡	55833	↔	Gas Ryder	⊖	645877	↔	Technomatic		
Golf	Pick-Up (Caddy I) Incl. Sport (serviceable strut) (Typ 14)	81-93			⚡	44511	↔	Technomatic	⊖	645877	↔	Technomatic		
Golf	Pick-Up (Sealed strut)	93 on			⚡	35849	↔	Technomatic	⊖	645877	↔	Technomatic		
Jetta	Mk I (Imported strut)	78-85		9	⚡	35849	↔	Technomatic	⚡	69050	↔	Gas Ryder		
					⚡	35849	↔	Technomatic	⚡	51006	↔	Technomatic		
Jetta	Mk I (local strut)	79-85		9	⚡	55833	↔	Gas Ryder	⚡	69050	↔	Gas Ryder		
					⚡	35849	↔	Technomatic	⚡	51006	↔	Technomatic		
					⚡	44511	↔	Technomatic	⚡	51006	↔	Technomatic		
Jetta	Mk II	85-92		9	⚡	55811	↔	Gas Ryder	⚡	69068	↔	Gas Ryder		
Jetta	Mk III	95-99		9	⚡	55841	↔	Gas Ryder	⚡	69068	↔	Gas Ryder		4501
Jetta	Mk III CLi	94-99		9	⚡	55841	↔	Gas Ryder	⚡	69068	↔	Gas Ryder		4501
Jetta	Mk III (Excl. VR6), Mk II	93-94		9	⚡	55811	↔	Gas Ryder	⚡	69068	↔	Gas Ryder		4501
Jetta	Mk III VR6	93-99		9	⚡	55841	↔	Gas Ryder	⚡	69068	↔	Gas Ryder		
Jetta	Mk IV (with 22mm strut rod)	99-06			⚡	55872	↔	Gas Ryder	⊖	61262	↔	Gas Ryder		
Jetta	Mk IV 1.6 (with 20mm strut rod)	99-06			⚡	55881	↔	Gas Ryder	⊖	61262	↔	Gas Ryder		
Jetta	Mk V 50mm OE Strut Body (Excl. V5 & sport Susp.)	06-11			⚡	70546	↔	Gas Ryder	⊖	62018	↔	Gas Ryder		
Jetta	Mk V 55mm OE Strut Body (Excl. V5 & sport Susp.)	06-11			⚡	70560	↔	Gas Ryder	⊖	62018	↔	Gas Ryder		
Jetta	Mk VI (50mm OE Strut Body)	11 on			⚡	70546	↔	Gas Ryder	⊖	62018	↔	Gas Ryder		
Jetta	Mk VI (55mm OE Strut Body)	11 on			⚡	70775	↔	Gas Ryder	⊖	62018	↔	Gas Ryder		
Kombi	T1/T2 Microbus, Fleetline (swing axle Rear)	55-78			⊖	645419	↔	Technomatic	⊖	645419	↔	Technomatic		
					⊖	18727	↔	Technomatic	⊖	18727	↔	Technomatic		
Kombi	T2 Microbus (double jointed axle Rear)	68-80			⊖	645417	↔	Technomatic	⊖	645418	↔	Technomatic		
Kombi	T3 Microbus (Excl. Synchro 4X4)	80-02		12	⊖	55227	↔	Safari	⊖	656161	↔	Safari		4076
Kombi	T4 Transporter: Mini bus, Pick-Up & Panel Van Excl. synchro	99-04			⊖	83373	↔	Heavy Duty	⊖	83367	↔	Heavy Duty		
Kombi	T5 Kombi, Caravelle (Excl. 4-Motion)	04 on			⚡	70591	↔	Gas Ryder	⊖	62007	↔	Gas Ryder		
Kombi	T5 Transporter: Crew bus, Pick-Up & Panel Van (Excl. 4-Motion)	05 on			⚡	70591	↔	Gas Ryder	⊖	62007	↔	Gas Ryder		



V

Model	Derivative	Year	Vehicle Type	Fitment Guide# (pg 6)	FRONT				Rear				GASLIFT	
					Shock Info	Part #	L/R	Range	Shock Info	Part #	L/R	Range	Front	Rear
VOLKSWAGEN (CONT...)														
Passat	B1	74-81			/	44602	↔	Technomatic	⊕	G45715	↔	Technomatic		
Passat	B2	82-87		9	/	44602	↔	Technomatic	†	51016	↔	Technomatic	4067	4068
Passat	1.6, 1.8, 1.8T, 2.0, 1.9TDI Excl. 4X4 (B5)	99-05			†	69087	↔	Gas Ryder	⊖	69946	↔	Gas Ryder		
Passat	2.3VR5 Excl. 4X4 (B5)	99-05			†	69087	↔	Gas Ryder	⊖	69946	↔	Gas Ryder		
Passat	2.8 V6 (B5)	99-05			†	69087	↔	Gas Ryder	⊖	69946	↔	Gas Ryder		
Passat	B5 2.3 V5 & 2.8 4WD 4-Motion Syncro	99-05			†	69087	↔	Gas Ryder						
Passat	B6 All (Excluding Sport Susp. & 4WD 4-Motion Syncro	05-11			†	70560	↔	Gas Ryder						
Polo	Classic (Mk III)	96-02		9	†	55841	↔	Gas Ryder	†	69081	↔	Gas Ryder		4291
Polo	Playa (9N)	98-02		9	†	55841	↔	Gas Ryder	†	69081	↔	Gas Ryder		
Polo	Mk IV Excl. GTI	02-09			†	70503	↔	Gas Ryder	⊖	G45879	↔	Technomatic		
Polo	Mk V (Typ 6R) (Excl. GTi, Sport & Cross)	10 on			†	70714	↔	Gas Ryder	⊖	G45879	↔	Technomatic		
Polo	Vivo (Mk IV)	10 on			†	70714	↔	Gas Ryder	⊖	G45879	↔	Technomatic		
Sharan	Mk I, Mk IA, Mk IB	95-10			†	G35190	↔	Gas Ryder	⊕	69924	↔	Gas Ryder		
Tiguan	4-Motion AWD & FWD Excl. Elec. Susp.	08 - 12			†	70703	↔	Gas Ryder	⊖	62050	↔	Gas Ryder		
Touran	Type 1T	04 on			†	70703	↔	Gas Ryder	⊖	69506	↔	Gas Ryder		
VOLVO														
122	Amazon	62-71			+	G45001	↔	Technomatic	⊕	G45054	↔	Technomatic		
122	Amazon, B18	59-71			+	G45001	↔	Technomatic	+	G56119	↔	Safari		
850	Excl. self levelling & sport Susp.	94-97			†	G35128	↔	Gas Ryder	⊖	69901	↔	Gas Ryder		
					†	G35128	↔	Gas Ryder	⊖	69901	↔	Gas Ryder		
144, 164	B20, B30	68-71		15	±	G45398	↔	Technomatic						
144, 164	B20E, B30	72-74			±	G45398	↔	Technomatic						
C30	All	07 on			†	70633	L	Gas Ryder	⊖	62023	↔	Gas Ryder		
					†	70634	R	Gas Ryder	⊖	62023	↔	Gas Ryder		
C70	Excl. T5 (Mk I)	97-05			†	G35292	fg	Gas Ryder	⊖	69901	↔	Gas Ryder		
S40	(Mk I) Excl. & T4 Rear	95-00			†	G35220	L	Gas Ryder	†	G51269	↔	Gas Ryder		
					†	G35225	R	Gas Ryder	†	G51269	↔	Gas Ryder		
S40	(Mk I) Excl. & T4 Rear	00-04			†	70683	L	Gas Ryder	⊖	69110	↔	Gas Ryder		
					†	70684	R	Gas Ryder	⊖	69110	↔	Gas Ryder		
S40	(Mk II) Incl. T5	04-11			†	70633	L	Gas Ryder	⊖	62023	↔	Gas Ryder		
					†	70634	R	Gas Ryder	⊖	62023	↔	Gas Ryder		
S40	Mk II Incl. T5	04-11			†	70633	L	Gas Ryder	⊖	62023	↔	Gas Ryder		
					†	70634	R	Gas Ryder	⊖	62023	↔	Gas Ryder		
S60	Sedan	00-10			†	70785	↔	Gas Ryder	⊖	62082	↔	Gas Ryder		
S70, V70	Excl. &	97-00			†	G35292	↔	Gas Ryder	⊖	69901	↔	Gas Ryder		



**VEHICLE LISTING –
SHOCKS
HEAVY COMMERCIAL VEHICLES**



B

Model	Derivative	Year	Vehicle Type	Fitment Guide# (pg 6)	FRONT				Rear				GASLIFT	
					Shock Info	Part #	L/R	Range	Shock Info	Part #	L/R	Range	Front	Rear
BEDFORD														
4x4	Truck	70-80			⊗	76015	↔	Fleet Ryder	⊗	76015	↔	Fleet Ryder		
CF Series	Van, Truck	70-84							⊗	656102	↔	Safari		
ELR4, ELR 6, ELR A, ELR 8	Truck	75-79			⊗	76015	↔	Fleet Ryder						
J2-4	Truck	65 on			†	656119	↔	Safari	⊗	656116	↔	Safari		
J5-6	Truck	65 on			†	656119	↔	Safari	⊗	656126	↔	Safari		
KE, KG, KH All	Truck	64 on			⊗	76015	↔	Fleet Ryder	⊗	76015	↔	Fleet Ryder		
					⊗	656126	↔	Safari	⊗	656126	↔	Safari		
KM All	Truck	72 on			⊗	76042	↔	Fleet Ryder						
MFR	Truck	67-71			⊗	76015	↔	Fleet Ryder	⊗	76015	↔	Fleet Ryder		
					⊗	656126	↔	Safari	⊗	656126	↔	Safari		
MFR	Truck	72 on			⊗	656174	↔	Safari	⊗	656174	↔	Safari		
VAL	Bus	66 on			⊗	76015	↔	Fleet Ryder						
					⊗	656126	↔	Safari						
VAM	Bus	73-75			⊗	656174	↔	Safari	⊗	656174	↔	Safari		
VAM	Bus	76 on			†	76009	↔	Fleet Ryder						
YRT	Bus	19...			⊖	76103	↔	Fleet Ryder						
BUSSING														
14, 15 AK	Truck	19...							⊗	76019	↔	Fleet Ryder		
16L, LBL, LU, UK	Truck	19...			⊗	76033	↔	Fleet Ryder						
19L, BBL	Truck	19...			†	76006	↔	Fleet Ryder						
22L, BLL (Tag axle)	Truck	19...							†	76034	↔	Fleet Ryder		
CASSPIR														
Casspir	Armoured Vehicle	19...			⊗	77007	↔	Fleet Ryder	⊗	77008	↔	Fleet Ryder		
DAF														
AT1900	Truck	19...			⊗	76007	↔	Fleet Ryder	⊗	76007	↔	Fleet Ryder		
FA2200, F2200	Truck	72-80			⊖	76035	↔	Fleet Ryder	†	76034	↔	Fleet Ryder		
FT 2200 DU	Truck	72-80			†	77004	↔	Fleet Ryder						
FTT 2800 DKTD	Truck	75-82			⊖	76035	↔	Fleet Ryder	†	76020	↔	Fleet Ryder		
ERF														
E6 (air susp.)	Truck	19...			†	76006		Fleet Ryder						
ERF	Truck	19...			⊖	76035	↔	Fleet Ryder						
Trailblazer	Trailblazer Bus	19...		32	⊖	76103	↔	Fleet Ryder	⊖	76103	↔	Fleet Ryder		
FIAT														
130NR	Truck	77-83			⊗	76017	↔	Fleet Ryder						
619T1	Truck	69-80			⊗	77022	↔	Fleet Ryder						
682 SWB	Truck	19...			⊗	76017	↔	Fleet Ryder						
684N, 684T	Truck	71-81			⊗	76017	↔	Fleet Ryder						

VEHICLE LISTING

Shocks, Struts, Gaslifts & Cartridges – HVC

FORD



F

Model	Derivative	Year	Vehicle Type	Fitment Guide# (pg 6)	FRONT				Rear				GASLIFT	
					Shock Info	Part #	L/R	Range	Shock Info	Part #	L/R	Range	Front	Rear
FORD														
Cargo	0608, 0808	82-86			+	76034	↔	Fleet Ryder	⊗	76042	↔	Fleet Ryder		
Cargo	0912, 1112, 1113	82-86			+	76034	↔	Fleet Ryder	⊗	76042	↔	Fleet Ryder		
Cargo	1212, 1213	82-85			+	76034	↔	Fleet Ryder	⊗	76042	↔	Fleet Ryder		
Cargo	1312, 1313	82-86			+	76034	↔	Fleet Ryder	⊗	76042	↔	Fleet Ryder		
Cargo	2217	82-86			+	76034	↔	Fleet Ryder	⊗	76042	↔	Fleet Ryder		
Cargo	1317, 1517	82-86			+	76034	↔	Fleet Ryder	⊗	76042	↔	Fleet Ryder		
D1210, D1211	Truck	78-82			+	76009	↔	Fleet Ryder	⊗	76007	↔	Fleet Ryder		
D1311, D1414	Truck	72-82			+	76009	↔	Fleet Ryder	⊗	76007	↔	Fleet Ryder		
DA 2114	Truck	74-82			+	76009	↔	Fleet Ryder	⊗	76007	↔	Fleet Ryder		
DO 607, DO 807	Truck	73-82			+	76009	↔	Fleet Ryder	⊗	76007	↔	Fleet Ryder		
DO 910, D1010	Truck	71-82			+	76009	↔	Fleet Ryder	⊗	76007	↔	Fleet Ryder		
DT 2014	Truck	72-82			+	76009	↔	Fleet Ryder	⊗	76007	↔	Fleet Ryder		
Triton	0510, 0610	85-87			⊖	55088	↔	Safari	⊗	G56102	↔	Safari		
Triton	0608, 0610	87 on			⊖	55211	↔	Safari						
FREIGHTLINER														
Argosy 90 (air susp.)	Truck	19...			⊗	85918	↔	Heavy Duty	⊗	85724	↔	Heavy Duty		
FL112 Series	Truck	19...		28	⊗	85320	↔	Heavy Duty	⊗	85724	↔	Heavy Duty		
					⊗	85320	↔	Heavy Duty	⊗	85319	↔	Heavy Duty		
FL50, FL60, FL70, FL80	Truck	19...			⊗	77022	↔	Fleet Ryder						
HINO														
500	1626 Series	97 on			⊗	76207	↔	Fleet Ryder						
55/330, 55/350	Truck	85-94			⊗	76042	↔	Fleet Ryder						
9-136	Truck	02 on			⊖	55211	↔	Safari						
C40	Truck	93 on			⊗	76042	↔	Fleet Ryder						
FD 10-135	Truck	83-94			⊖	76132	↔	Fleet Ryder						
FE	Truck	83 on			⊖	76102	↔	Fleet Ryder						
FF13-133, FF14-173	Truck	83-94			⊗	76042	↔	Fleet Ryder						
GD, Super Dolphin	Truck	19...			⊗	76042	↔	Fleet Ryder						
KB 302, 342, 14-177	Truck	72-84			⊗	76042	↔	Fleet Ryder						
KL 340, KL360	Truck	72-83			⊖	76132	↔	Fleet Ryder						
KR 320, 360	Truck	74-84			⊖	76102	↔	Fleet Ryder						



INTERNATIONAL (TYCO)

VEHICLE LISTING

Shocks, Struts, Gaslifts & Cartridges – HVC

Model	Derivative	Year	Vehicle Type	Fitment Guide# (pg 6)	FRONT			Rear				GASLIFT		
					Shock Info	Part #	L/R	Range	Shock Info	Part #	L/R	Range	Front	Rear
INTERNATIONAL (TYCO)														
4700, 4900(4x2), 4900 (6x4)	Truck	93 on			+	76009	↔	Fleet Ryder						
9800 Eagle	Truck (Set back axle)	19...		27	⊖	76151	↔	Fleet Ryder	⊗	77018	↔	Fleet Ryder		
9800 Eagle	Truck (Set forward axle)	19...		27					⊗	77018	↔	Fleet Ryder		
ACCO 1600, 1830C	Truck	84-85			⊗	76042	↔	Fleet Ryder						
ACCO 1840D Mk II	Truck	79-83			⊗	76042	↔	Fleet Ryder						
E-Line	Truck	19...			⊗	76008	↔	Fleet Ryder						
Fleetstar	Truck	19...			⊗	76015	↔	Fleet Ryder						
Loadstar 1850	Truck	71-78			⊗	76015	↔	Fleet Ryder						
Paystar F5070/350	Truck	73-84			⊗	76042	↔	Fleet Ryder						
S2670-407T, S Series	Truck	80-85			+	76006	↔	Fleet Ryder						
Transtar COF-4070	Truck	75-79			⊗	76042	↔	Fleet Ryder						
Unistar R91	Truck	19...			⊗	76042	↔	Fleet Ryder	⊗	76042	↔	Fleet Ryder		
ISUZU														
BD	Bus	74 on			⊗	76042	↔	Fleet Ryder	+	76006	↔	Fleet Ryder		
CVR, 49N	Truck	79-89			⊖	76102	↔	Fleet Ryder						
CVR, EXR, FT	Truck	89 on			⊖	76016	↔	Fleet Ryder						
F5000 (FN), F6599 (FN)	Truck	88 on			⊖	76102	↔	Fleet Ryder						
F8000 (TN), F9000 (TT)	Truck	88 on			⊖	76016	↔	Fleet Ryder						
FRR500	Truck	19...			⊖	55211	↔	Safari						
FSR700	Truck	96 on			⊖	76016	↔	Fleet Ryder						
FTR800	Truck	96 on			⊖	76043	↔	Fleet Ryder						
FTR800 4x2 FC	Truck	97 on			⊖	76204	↔	Fleet Ryder						
FVR2200 Turbo	Truck	93 on			⊖	76103	↔	Fleet Ryder						
FVR900 Turbo	Truck	93 on			⊖	76103	↔	Fleet Ryder						
FVZ1400	Truck	94 on			⊖	76043	↔	Fleet Ryder						
JCR 360, FTR	Truck	79-86			⊖	G56166	↔	Safari						
JCR 500	Truck	19...			⊖	76108	↔	Fleet Ryder						
N2800 P	Truck	93 on		29	⊖	55211	↔	Safari	⊗	76015	↔	Fleet Ryder		
					⊖	55211	↔	Safari	⊗	G56126	↔	Safari		
N3000 P	Truck	87-90		29	⊖	55211	↔	Safari	⊗	76015	↔	Fleet Ryder		
					⊖	55211	↔	Safari	⊗	G56126	↔	Safari		
N3500D FN 3.5T LWB 4x2 F-C	Truck	88-99							⊗	55242	↔	Safari		

VEHICLE LISTING

Shocks, Struts, Gaslifts & Cartridges – HVC

ISUZU



Model	Derivative	Year	Vehicle Type	Fitment Guide# (pg 6)	FRONT				Rear				GASLIFT	
					Shock Info	Part #	L/R	Range	Shock Info	Part #	L/R	Range	Front	Rear
ISUZU (CONT...)														
N3500D, N4000 D	Truck	86 on			⊖	76108	↔	Fleet Ryder	⊗	76110	↔	Fleet Ryder		
N4000D FT LWB Turbo 4x2 F-C	Truck	88-99							⊗	55242	↔	Safari		
NKR	Truck	96 on			⊖	76132	↔	Fleet Ryder						
NKR55/99	Truck	19...		29	⊖	55211	↔	Safari	⊗	76015	↔	Fleet Ryder		
					⊖	55211	↔	Safari	⊗	G56126	↔	Safari		
NPR 300, 400	Truck	86 on			⊖	76108	↔	Fleet Ryder	⊗	76110	↔	Fleet Ryder		
NPR 300, 400	Truck	84-03			⊖	55243	↔	Safari						
NPR 400 4x2 F-C	Truck	98 on							⊗	55240	↔	Safari		
NQR 500T 4x2 F-C	Truck	98-06							⊗	55240	↔	Safari		
SBR 422, FJR	Truck	76-83			⊖	76132	↔	Fleet Ryder	⊖	76043	↔	Fleet Ryder		
					⊖	55088	↔	Safari	⊖	76043	↔	Fleet Ryder		
SFR, TD	Truck	72 on		31	⊗	76007	↔	Fleet Ryder						
SLR, VPR	Truck	72 on			⊗	76042	↔	Fleet Ryder						
SPZ	Truck	73-80			⊗	76042	↔	Fleet Ryder						
SPZ, SHZ, SPR, SHR	Truck	80 on			⊖	76016	↔	Fleet Ryder						
TL40-50	Truck	75 on		29	⊖	55211	↔	Safari	⊗	76015	↔	Fleet Ryder		
					⊖	55211	↔	Safari	⊗	G56126	↔	Safari		
TLD 24	Truck	77-88			⊖	55211	↔	Safari	⊗	G56186	↔	Safari		
TLD44, TLD54	Truck	77-89		29	⊖	55211	↔	Safari	⊗	76015	↔	Fleet Ryder		
					⊖	55211	↔	Safari	⊗	G56126	↔	Safari		
IVECO														
Daily	Panel Van 107Kw_D (50C15, 65C15, 70C15)	04 on			⊗	76208	↔	Fleet Ryder	⊗	76209	↔	Fleet Ryder		
Daily	Panel Van 92Kw_D (35S13, 50C13)	01-08			⊗	76208	↔	Fleet Ryder	⊗	76209	↔	Fleet Ryder		
Daily, Turbo Daily	35.10V, 45.10, A45.10, 40.10, 49.12, 59.12	95-00			⊗	42772	↔	Technomatic	⊗	42773	↔	Technomatic		
Daily, Turbo Daily	45.10, A45.10, 49.10	95-00			⊗	42772	↔	Technomatic	⊗	42772	↔	Technomatic		
Daily, Turbo Daily	49.10, 49.12, 59.12	19...			⊗	42772	↔	Technomatic	⊗	42772	↔	Technomatic		
Eurotech	MPL440E42T, 440E 34, 38, 42, 52	92 on			⊖	76156	↔	Fleet Ryder	⊗	76157	↔	Fleet Ryder		
Turbo Daily	42.12, 45.12, 54.12, 66.12	19...							⊗	42773	↔	Technomatic		



L

Model	Derivative	Year	Vehicle Type	Fitment Guide# (pg 6)	FRONT			Rear			GASLIFT		
					Shock Info	Part #	L/R	Range	Shock Info	Part #	L/R	Range	Front
LEYLAND													
AEC MK IV	Bus	19...			+	76009	↔	Fleet Ryder					
AEC MK IV (With Air Cushions)	Bus	19...			⊗	76042	↔	Fleet Ryder	⊗	76042	↔	Fleet Ryder	
AEC MK IV (Without Air Cushions)	Bus	19...			⊗	76042	↔	Fleet Ryder					
Buffalo	Truck	19...			+	76006	↔	Fleet Ryder					
Chieftain CH 4013, 14.10	Truck	79-86			⊗	76042	↔	Fleet Ryder					
Clydesdale CD23	Bus	19...			+	76009	↔	Fleet Ryder					
Crusader	Truck	19...			+	76020	↔	Fleet Ryder					
Eland	Bus	19...			+	76006	↔	Fleet Ryder	+	76006	↔	Fleet Ryder	
Eland EL 4114, 14.12	Truck	73-85			+	76009	↔	Fleet Ryder	⊗	76042	↔	Fleet Ryder	
FG 550, FG 420	Truck	68-77			⊗	G56102	↔	Safari	⊖	55088	↔	Safari	
Guy Victory J, Mk I	Bus	19...			+	76041	↔	Fleet Ryder	⊗	76042	↔	Fleet Ryder	
Guy Victory J, Mk II	Bus	19...			+	76020	↔	Fleet Ryder	+	76006	↔	Fleet Ryder	
Kudu 352 RA, A691	Bus	19...			+	76041	↔	Fleet Ryder	+	76006	↔	Fleet Ryder	
Leopard	Truck	19...			+	76041	↔	Fleet Ryder	+	76020	↔	Fleet Ryder	
Mammoth Major, Mandator	Truck	19...			+	76009	↔	Fleet Ryder					
Marathon	Truck	76-83			⊖	76016	↔	Fleet Ryder	⊖	76103	↔	Fleet Ryder	
Mastiff	Truck	19...			⊗	76042	↔	Fleet Ryder					
Monarch, 2TG4RE	Truck	19...			+	76009	↔	Fleet Ryder					
Pioneer Plus	Truck	19...			+	76006	↔	Fleet Ryder					
Road Train	Truck	19...			+	76006	↔	Fleet Ryder					
Super Comet	Truck	19...			+	76041	↔	Fleet Ryder					
Super Eland 22.12, 24.12	Truck	75-85			+	76041	↔	Fleet Ryder					
Swift	Bus	19...			⊖	76043	↔	Fleet Ryder					
Tiger	Bus	19...			+	76020	↔	Fleet Ryder	+	76009	↔	Fleet Ryder	
Worldmaster	Bus	19...			+	76009	↔	Fleet Ryder					
MACK													
786FS	Truck	19...			⊗	76014	↔	Fleet Ryder					
R600RST, F700RST Series	Truck	73-85			⊗	76040	↔	Fleet Ryder					

VEHICLE LISTING

Shocks, Struts, Gaslifts & Cartridges – HVC

MAGNIS



M

Model	Derivative	Year	Vehicle Type	Fitment Guide# (pg 6)	FRONT				Rear				GASLIFT	
					Shock Info	Part #	L/R	Range	Shock Info	Part #	L/R	Range	Front	Rear
MAGNIS														
Samil	20	19...			⊗	77003	↔	Fleet Ryder	†	77004	↔	Fleet Ryder		
Samil	50	19...			⊗	77005	↔	Fleet Ryder	†	77006	↔	Fleet Ryder		
Samil	100	19...			⊗	77005	↔	Fleet Ryder						
MAN														
16, 201	Truck	19...			⊗	76021	↔	Fleet Ryder	†	76020	↔	Fleet Ryder		
16.220	Bus	19...			⊗	76021	↔	Fleet Ryder	†	76020	↔	Fleet Ryder		
16, 281	Bus	19...			⊗	76019	↔	Fleet Ryder						
27, 463	Truck	19...			⊖	76131	↔	Fleet Ryder						
16.240 FT/FTS/ HT/HL/HAL/HAK	Truck	76-89			⊗	77003	↔	Fleet Ryder						
19.280 FT/FTS	Truck	78-90			⊗	77003	↔	Fleet Ryder						
19.292 FT/FTS	Truck	90-94			⊖	76131	↔	Fleet Ryder						
19.300FT, 19.320, 19.321 FT/FTS	Truck	85-90			⊖	76131	↔	Fleet Ryder						
19.362 FTS	Truck	89-93			⊖	76131	↔	Fleet Ryder						
22.192, 24.192 DHK, DHL	Truck	76-87			⊗	77003	↔	Fleet Ryder						
26.292 DFT/ DFTS/DFL/DFK	Truck	89 on			⊖	76131	↔	Fleet Ryder						
26.362 DFTS/ DFLS	Truck	90 on			⊖	76131	↔	Fleet Ryder						
26.372 DFT/DFTS	Truck	90-95			⊖	76131	↔	Fleet Ryder						
26.402 DFTS, 422	Truck	93 on			⊖	76131	↔	Fleet Ryder						
26.442, 26.552 DFTS	Truck	90 on			⊖	76131	↔	Fleet Ryder						
29.292 DFT/ DFTS/DFL/DFK	Truck	89-92			⊖	76131	↔	Fleet Ryder						
30.280 DHT	Truck	78-84			⊗	76021	↔	Fleet Ryder						
30.365 DFT/ DFTS/DFL	Truck	86-89			⊖	76131	↔	Fleet Ryder						
30.380 DFT/ DFTS/DFL	Truck	84-89			⊖	76131	↔	Fleet Ryder						
30.440 DFTS/DFL	Truck	87-90			⊖	76131	↔	Fleet Ryder						
F2000 27.463TS, 27.464 TS	Truck	19...			⊖	76131	↔	Fleet Ryder						
F2000 33.373KN, TN	Truck	19...			⊖	76131	↔	Fleet Ryder						
F2000 33.374K, L, T	Truck	19...			⊖	76131	↔	Fleet Ryder						
F2000 33.423TS	Truck	19...			⊖	76131	↔	Fleet Ryder						
F2000 40.464 TS	Truck	19...			⊖	76131	↔	Fleet Ryder						
M2000 14.153 L	Truck	19...			⊗	77003	↔	Fleet Ryder						
M2000 15.223L, 16.223L, K, LA	Truck	19...			⊖	76103	↔	Fleet Ryder						



M

Model	Derivative	Year	Vehicle Type	Fitment Guide# (pg 6)	FRONT				Rear				GASLIFT	
					Shock Info	Part #	L/R	Range	Shock Info	Part #	L/R	Range	Front	Rear
MERCEDES-BENZ														
1735	Truck	19...			⊗	76033	↔	Fleet Ryder	⊗	76033	↔	Fleet Ryder		
0.302, 0.305 (air susp.)	Bus	19...			+	76009	↔	Fleet Ryder	+	76009	↔	Fleet Ryder		
0.309D	Bus	19...			⊗	55210	↔	Safari	⊗	55210	↔	Safari		
1113, L, LK, LF, LP, LPK	Truck	68-94		30	⊗	76039	↔	Fleet Ryder	⊗	76021	↔	Fleet Ryder		
1113B, L, LK	Truck	68-94			⊗	76019	↔	Fleet Ryder						
1113B, LA, LAK	Truck	73-83			⊗	76033	↔	Fleet Ryder						
					⊗	77007	↔	Fleet Ryder						
1113B, LAS	Truck	73-83			⊗	76033	↔	Fleet Ryder	⊗	76104	↔	Fleet Ryder		
					⊗	77007	↔	Fleet Ryder	⊗	76104	↔	Fleet Ryder		
1113B, LS	Truck	68-94			⊗	76019	↔	Fleet Ryder	⊗	76104	↔	Fleet Ryder		
1213, 1213K, 1217, 1217K	Truck	79-94			⊗	76033	↔	Fleet Ryder	⊖	77001	↔	Fleet Ryder		
1213AK	Truck	79-94			⊗	76106	↔	Fleet Ryder	⊖	77001	↔	Fleet Ryder		
1313, L, LK	Truck	72-76			⊗	76019	↔	Fleet Ryder	⊗	76022	↔	Fleet Ryder		
1313, LAK, LAS, LA	Truck	19...			⊗	76033	↔	Fleet Ryder	⊗	76104	↔	Fleet Ryder		
					⊗	77007	↔	Fleet Ryder	⊗	76104	↔	Fleet Ryder		
1313LS	Truck	19...			⊗	76019	↔	Fleet Ryder	⊗	76104	↔	Fleet Ryder		
1317L, LK	Truck	19...			⊗	76019	↔	Fleet Ryder	⊗	76022	↔	Fleet Ryder		
1317LP, LPK	Truck	19...							⊗	76022	↔	Fleet Ryder		
1319LP, LPK	Truck	19...							⊗	76022	↔	Fleet Ryder		
1413L, 1413K, 1417, 1417K	Truck	82-93			⊗	77007	↔	Fleet Ryder	⊖	77001	↔	Fleet Ryder		
					⊗	76033	↔	Fleet Ryder	⊖	77001	↔	Fleet Ryder		
1413L, LK, LS	Truck	76-82							⊗	76022	↔	Fleet Ryder		
1418, L, LK	Truck	68-79			⊗	76021	↔	Fleet Ryder						
1418, LP, LPS	Truck	19...			⊗	76039	↔	Fleet Ryder						
1419, 1419K, 1419S	Truck	77-88			⊗	77007	↔	Fleet Ryder	⊖	77001	↔	Fleet Ryder		
					⊗	76033	↔	Fleet Ryder	⊖	77001	↔	Fleet Ryder		
1513, 1517LP, LPK	Truck	19...							⊗	76022	↔	Fleet Ryder		
1513, 1517LS	Truck	19...			⊗	76019	↔	Fleet Ryder	⊗	76104	↔	Fleet Ryder		
1513L, LK	Truck	70-75			⊗	76019	↔	Fleet Ryder	⊗	76022	↔	Fleet Ryder		
1513LA, LAK	Truck	19...			⊗	77007	↔	Fleet Ryder	⊗	76104	↔	Fleet Ryder		
					⊗	76033	↔	Fleet Ryder	⊗	76104	↔	Fleet Ryder		
1517, 1519, L, LK	Truck	75-80			⊗	76019	↔	Fleet Ryder	⊗	76022	↔	Fleet Ryder		
1517, 1519, LA, LAK	Truck	76-94			⊗	77007	↔	Fleet Ryder	⊗	76104	↔	Fleet Ryder		
					⊗	76033	↔	Fleet Ryder	⊗	76104	↔	Fleet Ryder		

VEHICLE LISTING

Shocks, Struts, Gaslifts & Cartridges – HVC

MERCEDES-BENZ



M

Model	Derivative	Year	Vehicle Type	Fitment Guide# (pg 6)	FRONT				Rear				GASLIFT	
					Shock Info	Part #	L/R	Range	Shock Info	Part #	L/R	Range	Front	Rear
MERCEDES-BENZ (CONT...)														
1517, 1519, LAS	Truck	19...			∅	77007	↔	Fleet Ryder	∅	76022	↔	Fleet Ryder		
					∅	76033	↔	Fleet Ryder	∅	76022	↔	Fleet Ryder		
1617, LP, LPK	Truck	19...			∅	76033	↔	Fleet Ryder	∅	76022	↔	Fleet Ryder		
1618, L, LK	Truck	19...			∅	76021	↔	Fleet Ryder						
1619, LP	Truck	19...			∅	76033	↔	Fleet Ryder	∅	76022	↔	Fleet Ryder		
1620, L, LK	Truck	19...			∅	76021	↔	Fleet Ryder						
1621, L, LK, LS	Truck	77-79			∅	76019	↔	Fleet Ryder						
1623, L, LK, LAK	Truck	19...			∅	76021	↔	Fleet Ryder						
1624, L, LK, LAK, LS, LAS	Truck	19...			∅	76019	↔	Fleet Ryder						
1813L	Truck	19...			∅	77007	↔	Fleet Ryder						
					∅	76033	↔	Fleet Ryder						
1817, 1819, L	Truck	19...			∅	77007	↔	Fleet Ryder						
					∅	76033	↔	Fleet Ryder						
1918, 1920, L, LK	Truck	19...			∅	76021	↔	Fleet Ryder						
1921, L, LK, LS	Truck	70-77			∅	76019	↔	Fleet Ryder						
1923L, LK	Truck	19...			∅	76021	↔	Fleet Ryder						
1924, L, LK, LA, LAK, LS, LAS	Truck	19...			∅	76019	↔	Fleet Ryder						
1926S, 1928, 1928S, 1933S	Truck	81-92			∅	77007	↔	Fleet Ryder	∅	76033	↔	Fleet Ryder		
					∅	76033	↔	Fleet Ryder	∅	76033	↔	Fleet Ryder		
2017, 2019, L, LB	Truck	19...			∅	77007	↔	Fleet Ryder						
					∅	76033	↔	Fleet Ryder						
2219, 2219K, 2224	Truck	82-93			∅	76106	↔	Fleet Ryder						
2220, L, LA, LS, LAS	Truck	19...			∅	76021	↔	Fleet Ryder						
2224B, 2225B	Truck	86-93			∅	76106	↔	Fleet Ryder						
2233S	Truck	82-86			∅	76033	↔	Fleet Ryder						
2620, L, LA, LS, LAS	Truck	19...			∅	76021	↔	Fleet Ryder						
2623, L, LS, LK, LA, LAS, LAK	Truck	19...			∅	76021	↔	Fleet Ryder						
2624, A, AK, K, S	Truck	81-88			∅	77007	↔	Fleet Ryder						
2624, A, AK, K, S	Truck	81-88			∅	76033	↔	Fleet Ryder						
2624, L, LS, LK, LAK, LAS, LB, LAB	Truck	70-81			∅	76033	↔	Fleet Ryder						
2628K, A, S	Truck	81-93			∅	77007	↔	Fleet Ryder						
2628K, A, S	Truck	81-93			∅	76033	↔	Fleet Ryder						



M

Model	Derivative	Year	Vehicle Type	Fitment Guide# (pg 6)	FRONT			Rear				GASLIFT			
					Shock Info	Part #	L/R	Range	Shock Info	Part #	L/R	Range	Front	Rear	
MERCEDES-BENZ (CONT...)															
2629, LA, LAK, LAS	Truck	19...			⊗	76021	↔	Fleet Ryder							
2632, L, K, AK, S, AS	Truck	75-83			⊗	77007	↔	Fleet Ryder							
					⊗	76033	↔	Fleet Ryder							
2633S, 2636S, 2638S	Truck	83-93			⊗	77007	↔	Fleet Ryder							
					⊗	76033	↔	Fleet Ryder							
2644S/32	Truck	94 on			⊗	76033	↔	Fleet Ryder							
3328S, 3333S	Truck	87-92			⊗	77007	↔	Fleet Ryder							
					⊗	76033	↔	Fleet Ryder							
352 F	Bus	19...			⊗	76036	↔	Fleet Ryder	⊗	76022	↔	Fleet Ryder			
608 LP, LPK, LPS, LPO	Truck	19...							⊗	55210	↔	Safari			
609, 811 LP, LPS, LPK	Truck	19...							⊗	55210	↔	Safari			
808 LP, LPS, LPK	Truck	19...							⊗	55210	↔	Safari			
911B, L, LK	Truck	19...			⊗	76019	↔	Fleet Ryder							
911B, LA, LAK	Truck	19...			⊗	77007	↔	Fleet Ryder							
					⊗	76033	↔	Fleet Ryder							
911B, LAS	Truck	19...			⊗	77007	↔	Fleet Ryder	⊗	76104	↔	Fleet Ryder			
					⊗	76033	↔	Fleet Ryder	⊗	76104	↔	Fleet Ryder			
911B, LS	Truck	19...			⊗	76019	↔	Fleet Ryder	⊗	76104	↔	Fleet Ryder			
Actros	1831LS/36, 1835/36	19...			⊗	76033	↔	Fleet Ryder							
Actros	2031 S/36	99 on			⊗	76033	↔	Fleet Ryder							
Actros	2643 LS/33, 2649LS/32	99 on			⊗	76033	↔	Fleet Ryder							
Actros	3335 S/33	99 on			⊗	76033	↔	Fleet Ryder							
Actros	3343 S/33	99 on			⊗	76033	↔	Fleet Ryder							
Atego	1017/48, 48AK, /36	19...			⊗	76033	↔	Fleet Ryder							
Econoliner	1014/48, 1214/48	95 on			⊗	76033	↔	Fleet Ryder							
Econoliner	1414K/36, 1414/48	92 on			⊗	76033	↔	Fleet Ryder							
Econoliner	1617/48 & 52	94 on			⊗	76033	↔	Fleet Ryder	⊕	77001	↔	Fleet Ryder			
Econoliner	1617A/36, 1617K/36	92 on			⊗	76033	↔	Fleet Ryder	⊕	77001	↔	Fleet Ryder			
Econoliner	1623S/36	96 on			⊗	76033	↔	Fleet Ryder							
L1013, 1013K, 1014	Truck	81-87			⊗	76033	↔	Fleet Ryder	⊕	77001	↔	Fleet Ryder			
L408, L508, L608	Truck	79 on			⊗	55210	↔	Safari	⊗	55210	↔	Safari			
LA1213B	Truck	79-89			⊗	77007	↔	Fleet Ryder	⊗	76104	↔	Fleet Ryder			
LA1213B	Truck	79-89			⊗	76033	↔	Fleet Ryder	⊗	76104	↔	Fleet Ryder			

VEHICLE LISTING

Shocks, Struts, Gaslifts & Cartridges – HVC

MERCEDES-BENZ



M

Model	Derivative	Year	Vehicle Type	Fitment Guide# (pg 6)	FRONT				Rear				GASLIFT	
					Shock Info	Part #	L/R	Range	Shock Info	Part #	L/R	Range	Front	Rear
MERCEDES-BENZ (CONT...)														
MB 800	Bus	19...			⊗	55210	↔	Safari						
MB 800	Truck	19...			⊗	55210	↔	Safari						
OF 1113, 1313, 1317/51, 1413, 1417/52, 1617	Bus	19...			⊗	76036	↔	Fleet Ryder	⊗	76022	↔	Fleet Ryder		
OF 1621, 1624	Bus	86 on			⊗	76109	↔	Fleet Ryder	⊗	76104	↔	Fleet Ryder		
OH 1725L/59	Bus	19...			⊗	76033	↔	Fleet Ryder	†	76020	↔	Fleet Ryder		
OH 1835L/30	Bus	19...			⊗	76033	↔	Fleet Ryder	†	76020	↔	Fleet Ryder		
Powerliner	1729S/32	94 on			⊗	76033	↔	Fleet Ryder	⊗	76019	↔	Fleet Ryder		
					⊗	76033	↔	Fleet Ryder	⊗	76019	↔	Fleet Ryder		
Powerliner	2426B/32 & 52	92 on			⊗	76033	↔	Fleet Ryder						
Powerliner	2535S/32	94 on			⊗	76033	↔	Fleet Ryder						
Powerliner	2545S/32	96 on			⊗	76033	↔	Fleet Ryder						
Powerliner	2629K/32, 2629S/32, 2629/45	92 on			⊗	76033	↔	Fleet Ryder						
Powerliner	2635S/32, 2635/45	92 on			⊗	76033	↔	Fleet Ryder						
Powerliner	2638S/32	95 on			⊗	76033	↔	Fleet Ryder						
Powerliner	3836K/38	19...			⊗	76033	↔	Fleet Ryder						
Unimog	414, 416	19...			⊗	76014	↔	Fleet Ryder	⊗	76014	↔	Fleet Ryder		
Canter	Truck	80 on			⊖	55088	↔	Safari	⊗	G56102	↔	Safari		
FK Series	FK 115J/K	80-86			⊖	G56118	↔	Safari						
FM Series	FM215F/L	79-86			⊖	G56118	↔	Safari						
NISSAN														
Caball	Truck	64-78			2	G45138	↔	Technomatic	⊗	G56102	↔	Safari		
					2	G45138	↔	Technomatic	⊗	G45051	↔	Technomatic		
Caball	Truck	78-84			2	G45138	↔	Technomatic	⊗	G56157	↔	Safari		
					2	G45138	↔	Technomatic	⊗	G45432	↔	Technomatic		
Caball	Truck	96 on			2	G56179	↔	Safari	⊗	G56162	↔	Safari		
Cabstar	20, 35, 40	96 on							⊗	G56162	↔	Safari		
Cabstar	Truck	84-90			2	G56166	↔	Safari						
CB 20	Bus	19...			2	76103	↔	Fleet Ryder	⊖	76035	↔	Fleet Ryder		
CK10 K/A	Truck	74-86			2	76103	↔	Fleet Ryder						
CK20 D/L/N	Truck	73-83			2	76103	↔	Fleet Ryder						
CK25D/N	Truck	83-84			2	76103	↔	Fleet Ryder						
CK41 CT	Truck	80-85			2	76103	↔	Fleet Ryder						
CM 10 F	Truck	87 on			2	55088	↔	Safari						
CM 12/CM14	Truck	87 on			2	76016	↔	Fleet Ryder						



N

Model	Derivative	Year	Vehicle Type	Fitment Guide# (pg 6)	FRONT				Rear				GASLIFT		
					Shock Info	Part #	L/R	Range	Shock Info	Part #	L/R	Range	Front	Rear	
NISSAN (CONT...)															
CM 15 E	Truck	87-92			2	76103	↔	Fleet Ryder							
CM 16 N	Truck	90 on			2	76016	↔	Fleet Ryder							
CM 8 F	Truck	87-95			2	55088	↔	Safari							
CM 90	Truck (Condor)	19...			3	76041	↔	Fleet Ryder							
CW 350 HTA, HTF	Truck	93 on			2	76103	↔	Fleet Ryder							
CW290 HDN, PHN	Truck	93 on			2	76103	↔	Fleet Ryder							
CW290 PPA, HTA, HTF, CK290 CTA	Truck	93-95			2	76103	↔	Fleet Ryder							
CW41 H/P	Truck	77-85			2	76103	↔	Fleet Ryder							
CW45 HD/PA	Truck	82-89			2	76103	↔	Fleet Ryder							
CW46 HDN, HTF, HMF, HTA, PAN	Truck	89-93			2	76103	↔	Fleet Ryder							
CW46 PAF, PAA	Truck	89-92			2	76103	↔	Fleet Ryder							
CW47 HDN, HTA, HTF, PAF, PAN	Truck	93-95			2	76103	↔	Fleet Ryder							
CW55 HTF, CW56 HTF	Truck	89-95			2	76103	↔	Fleet Ryder							
UD 35	4x2 F-C	96-10			2	55236	↔	Safari	⊗	55237	↔	Safari			
UD 35A	4x2 F-C	96-10			2	55236	↔	Safari	⊗	55237	↔	Safari			
UD 40L	Truck	96 on			2	55236	↔	Safari	⊗	55237	↔	Safari			
UD 80	4x2 F-C	97 on			2	76205	↔	Fleet Ryder	+	76206	↔	Fleet Ryder			
UD780	Truck	69 on			2	76102	↔	Fleet Ryder							
UG 80	Bus	19...			2	76102	↔	Fleet Ryder							
UG780	Truck	69 on			2	76102	↔	Fleet Ryder							
OSHKOSH															
E-1344 T 290	Truck	78-83			0	76017	↔	Fleet Ryder							
E-1446 T 350	Truck	80-83			0	76017	↔	Fleet Ryder							
R Series	Truck	19...			0	76042	↔	Fleet Ryder							
PETERBILT															
320	Truck	95 on			0	76015	↔	Fleet Ryder							
362 E 436, 460, 550	Truck	95 on			0	77018	↔	Fleet Ryder							
377A/E	Truck	95 on			0	76015	↔	Fleet Ryder							
RENAULT															
CBH 385	Truck	96 on			3	77006	↔	Fleet Ryder							

VEHICLE LISTING

Shocks, Struts, Gaslifts & Cartridges – HVC

SCANIA



S

Model	Derivative	Year	Vehicle Type	Fitment Guide# (pg 6)	FRONT				Rear				GASLIFT	
					Shock Info	Part #	L/R	Range	Shock Info	Part #	L/R	Range	Front	Rear
SCANIA														
80, 110	Truck	19...			2	76016	↔	Fleet Ryder						
Bus	Bus	19...							†	76020	↔	Fleet Ryder		
K94	Bus	19...			2	76035	↔	Fleet Ryder						
LB 81 HS-31/50 4x2	Truck	75-82			2	76016	↔	Fleet Ryder	†	76006	↔	Fleet Ryder		
LBT 111-HS31 6X4	Truck	75-82			2	76016	↔	Fleet Ryder	†	76006	↔	Fleet Ryder		
LBT 141 HS-31/46 6X4	Truck	78-82			2	76016	↔	Fleet Ryder	†	76006	↔	Fleet Ryder		
P112H (6x2)	Truck	82-89			2	76035	↔	Fleet Ryder	†	76034	↔	Fleet Ryder		
P114GA 6x4 NZ 380	Truck	19...			2	76035	↔	Fleet Ryder						
P124 CB 6x4 NZ 470	Truck	19...			2	76035	↔	Fleet Ryder						
P124GA 400	Truck	19...			2	76035	↔	Fleet Ryder						
P124GA 6x4 NZ 420, 470	Truck	19...			2	76035	↔	Fleet Ryder						
P124LA 6x2 NA 420	Truck	19...			2	76035	↔	Fleet Ryder						
P142H (6x2)	Truck	82-89			2	76035	↔	Fleet Ryder	†	76034	↔	Fleet Ryder		
P82ML 4x2(S) 4x2	Truck	82-89			2	76035	↔	Fleet Ryder	†	76006	↔	Fleet Ryder		
P94LA 4x2 NA 310	Truck	19...			2	76035	↔	Fleet Ryder						
R112HL 6X4(S)	Truck	82-89			2	76035	↔	Fleet Ryder	†	76034	↔	Fleet Ryder		
R142H (6X4)	Truck	82-89			2	76035	↔	Fleet Ryder	†	76034	↔	Fleet Ryder		
SILVER EAGLE														
SAR Coach	Bus	19...			0	77002	↔	Fleet Ryder	⊗	76042	↔	Fleet Ryder		
TATA														
LPT 1518TC	Truck	05 on			0	76185	↔	Fleet Ryder	⊗	76186	↔	Fleet Ryder		
LPT 509M 4x2 F-C	Truck	19...			0	36863	↔	Technomatic	⊗	55232	↔	Safari		
LPT 709 3T 4x2 F-C	Truck	19...			0	55233	↔	Safari	⊗	55234	↔	Safari		
LPT 713 S 4x2 F-C	Truck	19...			0	55233	↔	Safari	⊗	55234	↔	Safari		
LPT 713 S Chassis 4x2 Bus	Truck	19...			0	55233	↔	Safari	⊗	55234	↔	Safari		
SFC 407 2T 4x2 F-C	Truck	19...			0	36863	↔	Technomatic	⊗	55232	↔	Safari		



T

Model	Derivative	Year	Vehicle Type	Fitment Guide# (pg 6)	FRONT				Rear				GASLIFT	
					Shock Info	Part #	L/R	Range	Shock Info	Part #	L/R	Range	Front	Rear
TOYOTA														
DA 110, 116	Truck	73 on			2	76016	↔	Fleet Ryder						
DA/KA	Truck	00 on			2	76043	↔	Fleet Ryder						
Dyna	4-093 4x2 F-C	02 on			2	36868	↔	Technomatic	⊗	36869	↔	Technomatic		
Dyna	5-103 4x2	08 on			2	36872	↔	Technomatic	⊗	55241	↔	Safari		
Dyna	5-104 4x2	03 on			2	36872	↔	Technomatic						
Dyna	6-104 4x2	04 on							⊗	36873	↔	Technomatic		
Dyna	6-104 4x2	96-03							⊗	36874	↔	Technomatic		
Dyna	7-094	89-00			2	G45908	↔	Technomatic	⊗	G45909	↔	Technomatic		
Dyna	7-095 F-C, 4x2 (ADE364C)	89-00			2	G45908	↔	Technomatic	⊗	G45909	↔	Technomatic		
Dyna	7-105	03-on							⊗	55239	↔	Safari		
Dyna	7-105 LWB 4T 4x2 F-C	89-00							⊗	36873	↔	Technomatic		
Dyna	7-145	08-on			2	55238	↔	Safari	⊗	55239	↔	Safari		
Dyna	8-145	03-on							⊗	55239	↔	Safari		
Dyna	COASTER	66-77			0	G56102	↔	Safari	⊗	G56116	↔	Safari		
Dyna	COASTER	78-95							⊗	G56102	↔	Safari		
Dyna	Truck	94 on							⊗	G56102	↔	Safari		
UNIMOG														
Buffel	414, 416 Truck	19..			0	76014	↔	Fleet Ryder	⊗	76014	↔	Fleet Ryder		
VOLVO														
B7F	Bus	19...			0	76042	↔	Fleet Ryder	⊗	76042	↔	Fleet Ryder		
F12, FL12, FH12	Truck	19...			0	76008	↔	Fleet Ryder						
F88, G88	Truck	19...			0	76042	↔	Fleet Ryder						
WESTERN STAR														
3842S	Truck	19...		26	0	76042	↔	Fleet Ryder						
3842S	Truck	19...		26	0	76017	↔	Fleet Ryder						
4842S, 4864S	Truck	19...		26	0	76042	↔	Fleet Ryder						
4842S, 4864S	Truck	19...		26	0	76017	↔	Fleet Ryder						
5964F, 5964F	Truck	19...		26	0	76042	↔	Fleet Ryder						
5964F, 5964F	Truck	19...		26	0	76017	↔	Fleet Ryder						

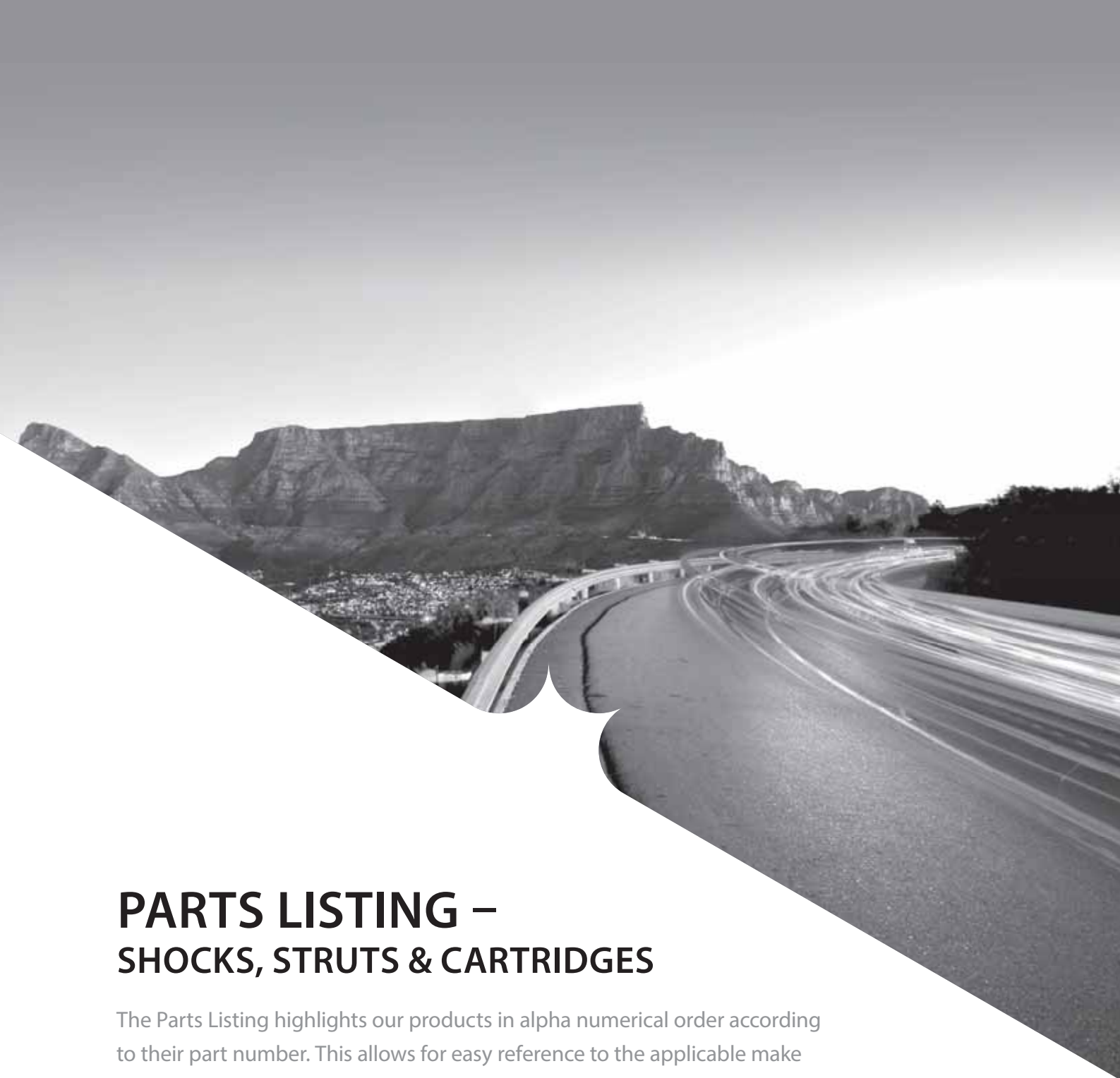

PARTS LISTING – SHOCKS, STRUTS & CARTRIDGES

The Parts Listing highlights our products in alpha numerical order according to their part number. This allows for easy reference to the applicable make and model of the vehicles when finding an application or applications which use that Gabriel part number.

The product ranges for each part number is indicated. For more detailed information on the Gabriel ranges, please refer to pages 8-10. For product dimensions and end-mountings refer to the Technical Section starting from page 153.

Some Gabriel Europe imports are stamped with a manufacturing number and are not listed in this section and these will be found in our Parts Finder section starting from page 123.



14004

PARTS LISTING

Shocks & Struts

14004 – 35830

Part #	Range	Superceding Part#/Status	Product Type	Make	Model	Derivative	Year	Position	L/R	Note # (pg 6)
14004	Steering Damper		15	Volkswagen	Beetle	All	52-79	Front		
14011	Steering Damper		15	Land Rover	Range Rover	SUV	76-94	Front		
				Land Rover	Range Rover, Discovery	SUV	76-98	Front		
14012	Steering Damper		15	Audi	100, 200	PC	81-84	Front		
				Isuzu	KB, TF Series	4x2, 4x4	81-03	Front		
14013	Steering Damper		15	Land Rover	Defender	109", 110" WB, Series 11, 111	65-84	Front		
14014	Steering Damper		15	Opel	Commodore, Rekord	Incl. 2500, 3800, 4100	78-97	Front		
14021	Steering Damper		15	Toyota	Hilux	4x4	79-98	Front		
14022	Steering Damper		15	Nissan	Patrol	4x4	82-90	Front		
				Nissan	Safari	SUV	82-90	Front		
14023	Steering Damper		15	Toyota	Landcruiser	FJ45, BJ45	71-85	Front		
14024	Steering Damper		15	Toyota	Landcruiser	FJ62, BJ60, BJ75	83-99	Front		
				Toyota	Landcruiser	HZJ 80	90-98	Front		
14032	Steering Damper		15	Land Rover	Defender	90, 110, 130 (Incl. Defender, County)	84-07	Front		
14033	Steering Damper		15	Toyota	Hilux	4x4	99-05	Front		
14040	Steering Damper		15	Jeep (Chrysler)	Jeep	Cherokee	93-01	Front		
18727	Technomatic		⊕ 8,5	Volkswagen	Beetle	Mk I	52-79	Front	←→	4
				Volkswagen	Kombi	Microbus, Fleetline (Swing Axle Rear)	55-78	Front	←→	
				Volkswagen	Kombi	Microbus, Fleetline (Swing Axle Rear)	55-78	Rear	←→	
19021	Technomatic		⊕ 8,5	Austin, Morris	Mini	Excl. Hydrolastic Susp.	59-85	Front	←→	
				Austin, Morris	Mini	Incl. Cooper	59-80	Front	←→	
				Austin, Morris	Mini	Incl. Mk III	61-79	Front	←→	
19022	Technomatic		⊕ 6,2	Renault	R8, R10	Small sedan	62-70	Front	←→	
				Austin, Morris	Mini	Excl. Hydrolastic Susp.	59-85	Rear	←→	
				Austin, Morris	Mini	Incl. Cooper	59-80	Rear	←→	
				Austin, Morris	Mini	Incl. Mk III	61-79	Rear	←→	
				Renault	R8, R10	Small sedan	62-70	Rear	←→	
19289	Technomatic		⊕ 4	Nissan	Langley, Pulsar	Incl. Panache (N10)	80-83	Rear	←→	
19290	Technomatic		⊕ 13,2	Toyota	1200	LDV	78-82	Rear	←→	
35117	Technomatic		⌚ 1,1	Renault	Laguna	I (Excl. Station Wagon)	96-00	Front	←→	
35816	Technomatic		⌚ 1,1	Ford	Bantam	1300, 1600	83-86	Front	←→	
				Ford	Escort	Mk III FWD L, GL, GLE	81-86	Front	←→	
				Ford	Escort	Mk III FWD XR3, Sport	81-86	Front	←→	
				Mazda	Rustler	130, 160	85-86	Front	←→	
35817	Technomatic		⌚ 1,2	Ford	Escort	Mk III FWD L, GL, GLE	81-86	Rear	←→	
				Ford	Escort	Mk III FWD XR3, Sport	81-86	Rear	←→	
35824	Technomatic		⌚ 1,1	Renault	R9, R11	Saloon, Hatchback	83-86	Front	←→	
35830	Technomatic		⌚ 1,1	Honda	Ballade	Civic	82-84	Front	←→	



Part #	Range	Superceding Part #/Status	Product Type	Make	Model	Derivative	Year	Position	L/R	Note # (pg 6)
35832	Technomatic		1,1	Ford	Laser, Meteor, Tracer	KC/KE, GC	86-91	Front	↔	
				Mazda	323	Incl. S (non sealed Strut)	81-83	Front	↔	
				Mazda	323	Incl. S, EGi, Sport	82-91	Front	↔	
35833	Technomatic		1,1	Ford	Laser, Meteor, Tracer	KC/KE, GC	86-91	Rear	↔	
				Ford	Laser, Meteor, Tracer	KF/KH	91-01	Rear	↔	
				Mazda	323	Incl. Midge	91-04	Rear	↔	
				Mazda	323	Incl. S (non sealed Strut)	81-83	Rear	↔	21
				Mazda	323	Incl. S, EGi, Sport	82-91	Rear	↔	
35834	Technomatic	55806	1,1	Mazda	626	Incl. Coupe (Mk II, Mk III)	83-92	Front	↔	
35836	Technomatic		1,1	Mitsubishi	Tredia	Excl. Turbo	83-86	Front	↔	
35842	Technomatic		1,1	Ford	Sierra, Sapphire	2300, 2000, 1600	83-93	Front	↔	
				Ford	Sierra, Sapphire	3000 (Incl. XR6)	83-93	Front	↔	
				Ford	Sierra, Sapphire	Estate	83-93	Front	↔	
35843	Technomatic	55810	1,1	Honda	Ballade	130, 150, 150i (SC9) (Civic)	84-87	Front	↔	
35844	Technomatic		1,1	Ford	Bantam	1400, 1600	86-94	Front	↔	
				Mazda	Rustler	1400, 1600	86-94	Front	↔	
35845	Technomatic	55812	1,1	Toyota	Conquest	FWD (E80)	85-89	Front	↔	
				Toyota	Corolla	FWD (Incl. Avante) (E80)	85-89	Front	↔	
35846	Technomatic	55813	1,1	Toyota	Conquest	FWD (E80)	85-89	Rear	↔	
				Toyota	Corolla	FWD (Incl. Avante) (E80)	85-89	Rear	↔	
35847	Technomatic		1,1	Nissan	Langley, Pulsar	Incl. Exa (sealed Strut) (N12)	83-88	Front	↔	
35848	Technomatic		1,1	Ford	Laser, Meteor, Tracer	KF/KH	91-01	Front	↔	
				Mazda	323	Incl. Midge	91-04	Front	↔	
35849	Technomatic		1,1	Volkswagen	Citi	Incl. Chico (Excl. Sonic, Life & VeloCiti)	84 on	Front	↔	
				Volkswagen	Citi	Sonic, Life & VeloCiti	98 on	Front	↔	
				Volkswagen	Fox	Incl. Shuttle	87-95	Front	↔	
				Volkswagen	Golf	Mk I (Imported Strut)	78-79	Front	↔	
				Volkswagen	Golf	Mk I (Local Strut)	79-84	Front	↔	
				Volkswagen	Golf	Pickup (sealed Strut)	93-03	Front	↔	
				Volkswagen	Jetta	Mk I (Imported Strut)	78-85	Front	↔	
				Volkswagen	Jetta	Mk I (Local Strut)	79-85	Front	↔	
35916	Technomatic	55816	1,1	Nissan	Sentra	Sedan, Coupe (B12)	87-92	Front	↔	
35917	Technomatic	55817	1,1	Nissan	Sentra	Sedan, Coupe (B12)	87-92	Rear	↔	
35920	Technomatic	55854	1,1	Fiat	Uno	Incl. Turbo (Series 2)	90-06	Front	↔	
35922	Technomatic	55811	1,1	Volkswagen	Golf	Mk III (Excl. VR6 & Cabriolet), Mk II All (Excl. Cabriolet)	93-94	Front	↔	
				Volkswagen	Jetta	Mk III (Excl. VR6), Mk II	93-94	Front	↔	



35923

PARTS LISTING

Shocks & Struts

35923 - 36767

Part #	Range	Superceding Part#/Status	Product Type	Make	Model	Derivative	Year	Position	L/R	Note # (pg 6)
35923	Technomatic	55838	1,1	Nissan	Sabre	160, 200 (Excl. ABS)	92-01	Front	L	
				Nissan	Sentra	140	92-01	Front	L	
				Nissan	Sentra	160, 200 (Excl. STi)	92-01	Front	L	
35924	Technomatic	55839	1,1	Nissan	Sabre	160, 200 (Excl. ABS)	92-01	Front	R	
				Nissan	Sentra	140	92-01	Front	R	
				Nissan	Sentra	160, 200 (Excl. STi)	92-01	Front	R	
35925	Technomatic	55840	1,1	Nissan	Sentra	140	92-01	Rear	←→	
35926	Technomatic	55841	1,1	Volkswagen	Golf	Mk III All (Excl. Cabriolet)	95-99	Front	←→	
				Volkswagen	Golf	Mk III GTi	94-99	Front	←→	
				Volkswagen	Jetta	Mk III	95-99	Front	←→	
				Volkswagen	Jetta	Mk III Cli	94-99	Front	←→	
				Volkswagen	Polo	Classic (Mk III)	96-02	Front	←→	
				Volkswagen	Polo	Playa (9N)	98-02	Front	←→	
35927	Technomatic		1,1	Ford	Bantam	1300, 1600	94-02	Front	←→	
				Mazda	Rustler	1300, 1600	94-02	Front	←→	
35934	Technomatic		1,1	Tata	Indica	1.4 Hatch (V2) (Incl. B-Line, Excl. TDi & ABS)	04 on	Front	L	
35935	Technomatic		1,1	Tata	Indica	1.4 Hatch (V2) (Incl. B-Line, Excl. TDi & ABS)	04 on	Front	R	
35941	Technomatic		1,1	Chevrolet	Aveo	T200 (Kalos) Gen 1	02-11	Front	L	
35942	Technomatic		1,1	Chevrolet	Aveo	T200 (Kalos) Gen 1	02-11	Front	R	
35943	Technomatic		1,1	Kia	Clarus	2.0 GLX (Credos)	98-06	Front	L	
35944	Technomatic		1,1	Kia	Clarus	2.0 GLX (Credos)	98-06	Front	R	
35945	Technomatic		1,1	Kia	Clarus	2.0 GLX (Credos)	98-06	Rear	L	
35946	Technomatic		1,1	Kia	Clarus	2.0 GLX (Credos)	98-06	Rear	R	
35951	Technomatic		1,1	Hyundai	Atoz	Includes Prime (Mk II)	99 on	Front	L	
35952	Technomatic		1,1	Hyundai	Atoz	Includes Prime (Mk II)	99 on	Front	R	
35953	Technomatic		1,1	Chana	Star	Bakkie, P-Van, Minibus (Incl. Maxi Star)	06 on	Front	L	
35954	Technomatic		1,1	Chana	Star	Bakkie, P-Van, Minibus (Incl. Maxi Star)	06 on	Front	R	
35955	Technomatic		1,1	Chery	QQ3 0.8, 1.1 (S11)	Hatch	08 on	Front	L	
35956	Technomatic		1,1	Chery	QQ3 0.8, 1.1 (S11)	Hatch	08 on	Front	R	
36759	Technomatic	61201	7,1	Mercedes-Benz	114, 115 Series	220, 230, 240D, 280E, 280 (Excl. )	68-77	Front	←→	
36761	Technomatic		6,1	Mercedes-Benz	110 Series	190, 200, 230	62-67	Rear	←→	
				Mercedes-Benz	111 Series	220, 250, 280	60-68	Rear	←→	
				Mercedes-Benz	S Class	108 Series	68-73	Rear	←→	
36767	Technomatic		6,2	Nissan	Y' Series	1200	71-75	Rear	←→	
				Nissan	Y' Series	120Y, 140 SDX, (12" wheels)	75-80	Rear	←→	
				Nissan	Y' Series	140 SDX (13" wheels), 140Y, 160Y	75-80	Rear	←→	

Be safe. Be sure



Part #	Range	Superceding Part #/Status	Product Type	Make	Model	Derivative	Year	Position	L/R	Note # (pg 6)	
36847	Technomatic	61202	1/8	7,1	Mercedes-Benz	C Class	(W123) 200, 230E, 240D, 250, 280E, 300D (Excl. ①)	77-86	Front	↔	
					Mercedes-Benz	S Class	(116 Series) 280SE, 280S, 350SE (Excl. ①)	73-81	Front	↔	
					Mercedes-Benz	S Class	(W126) 280SE, 300SE, 380SE, 420SE, 500SE, 560SE Incl. SEL & SEC (Excl. ①)	81-93	Front	↔	
36850	Technomatic		1/6	6,2	Renault	R5	Mk I Hatchback	72-85	Front	↔	
					Renault	R5	Mk I P-Van	80-85	Front	↔	
36851	Technomatic		1/6	6,2	Renault	R5	Mk I Hatchback	72-85	Rear	↔	
					Renault	R5	Mk I P-Van	80-85	Rear	↔	
					Renault	R9, R11	Saloon, Hatchback	83-86	Rear	↔	
36853	Technomatic		1/6	6,2	Audi	100, 200	C2	77-84	Rear	↔	14
36854	Technomatic		1/6	6,2	Audi	100, 200	Excl. Coupe (C1)	72-74	Rear	↔	
					Audi	100, 200	Excl. Coupe (C1)	75-77	Rear	↔	
					Ford	Capri	Mk I	69-73	Rear	↔	
					Ford	Corsair	1.6	64-66	Rear	↔	
					Ford	Corsair	1.6, 2.0	66-69	Rear	↔	
					Ford	Cortina	Mk I	64-66	Rear	↔	
					Ford	Cortina	Mk II	67	Rear	↔	
					Ford	Cortina	Mk II	68-70	Rear	↔	
					Hillman	Vogue, Hunter	Incl. Sceptre, Arrow	67-77	Rear	↔	
					Nissan	Stanza	1600J, 1800J Stanza, Resort (A10)	78-83	Rear	↔	
36857	Technomatic		1/6	6,2	BMW	2 Series	1502, 2002 Ti Lux (E10)	66-77	Rear	↔	
					BMW	3 Series	E30 Series (Excl. iS & Cabriolet)	83-91	Rear	↔	14
36859	Technomatic	G56185	1/4	4	Isuzu	WFR, Relay	Fargo	80-95	Front	↔	
					Mitsubishi	Colt Bakkie	L200 (2.6, 3.0, V6 4x4, 4x2 raised height)	94-98	Front	↔	
					Toyota	Stallion	KF40	87-00	Front	↔	
					Toyota	Venture	KF40	91-00	Front	↔	
36860	Technomatic		2/6	8,5	Tata	Telcoline	4x4, 4x2	04 on	Rear	↔	
36862	Technomatic	G45886	2/6	8,4	Mahindra	Scorpio	4x2	05 on	Rear	↔	
					Mahindra	Scorpio	4x4	05 on	Rear	↔	
36863	Technomatic		2/6	8,5	Tata	LPT 509M 4x2 F-C	Truck	19...	Front	↔	
					Tata	SFC 407 2T 4x2 F-C	Truck	19...	Front	↔	
36865	Technomatic		1/6	6,1	Toyota	Rav 4	Sealed struts (XA10)	98-00	Rear	↔	
					Toyota	Rav 4	Serviceable struts (XA10)	96-98	Rear	↔	
36866	Technomatic		1/6	6,2	Chevrolet	Aveo	T200 (Kalos)	02 on	Rear	↔	
36867	Technomatic		2/6	8,5	Hyundai	Atoz	Includes Prime (Mk II)	99 on	Rear	↔	
36868	Technomatic		1/6	6,2	Toyota	Dyna	4-093 4x2 F-C	02 on	Front	↔	
36869	Technomatic		2/6	8,3	Toyota	Dyna	4-093 4x2 F-C	02 on	Rear	↔	

36847 - 36869



36870

PARTS LISTING

Shocks & Struts

36870 - 44500

Part #	Range	Superceding Part#/Status	Product Type	Make	Model	Derivative	Year	Position	L/R	Note # (pg 6)	
36870	Technomatic		1/2	6,1	Toyota	Dyna	7-094	89-00	Front	←→	
					Toyota	Dyna	7-095 F-C	89-00	Front	←→	
					Toyota	Dyna	7-095 4x2 (ADE364C)	89-00	Front	←→	
36871	Technomatic	G45908	2	8,2	Toyota	Dyna	7-094	89-00	Rear	←→	
					Toyota	Dyna	7-095 F-C	89-00	Rear	←→	
					Toyota	Dyna	7-095 4x2 (ADE364C)	89-00	Rear	←→	
36872	Technomatic	G45909	2	8,2	Toyota	Dyna	5-103 4x2	08 on	Front	←→	
					Toyota	Dyna	5-104 4x2	03 on	Front	←→	
36873	Technomatic		2	8,2	Toyota	Dyna	7-105 LWB 4T 4x2 F-C	89-00	Rear	←→	
					Toyota	Dyna	6-104 4x2	03 on	Rear	←→	
36874	Technomatic		2	8,2	Toyota	Dyna	6-104 4x2	96-03	Rear	←→	
36875	Technomatic		2	8,5	Chery	QQ3 0.8, 1.1 (S11)	Hatch	08 on	Rear	←→	
36876	Technomatic		1/2	6.1	Toyota	Ipsum	(SM10)	96-01	Rear	←→	
42772	Technomatic		2	8,5	Iveco	Daily	49.10, 49.12, 59.12	19...	Front	←→	
					Iveco	Daily, Turbo Daily	35.10V, 45.10, A45.10, 40.10, 49.12, 59.12	95-00	Front	←→	
					Iveco	Daily, Turbo Daily	45.10, A45.10, 49.10	95-00	Front	←→	
					Iveco	Daily	49.10, 49.12, 59.12	19...	Rear	←→	
					Iveco	Daily, Turbo Daily	45.10, A45.10, 49.10	95-00	Rear	←→	
42773	Technomatic		2	8,5	Iveco	Daily, Turbo Daily	35.10V, 45.10, A45.10, 40.10, 49.12, 59.12	95-00	Rear	←→	
					Iveco	Turbo Daily	42.12, 45.12, 54.12, 66.12	19...	Rear	←→	
42864	Technomatic		2	8,5	Mercedes-Benz	Sprinter	308D, 312D (903)	95 on	Rear	←→	
					Mercedes-Benz	Sprinter 308D	Truck	96 on	Rear	←→	
					Mercedes-Benz	Sprinter 312D	Truck	96 on	Rear	←→	
42942	Technomatic	G56268	2	8,5	Mercedes-Benz	Vito	115 CDI 2.2 Bus MPV Dsl (W639)	04 on	Rear	←→	
					Mercedes-Benz	Vito	115 CDI 2.2 Cr-Cab P-Van Dsl (W639)	04 on	Rear	←→	
					Mercedes-Benz	Vito	115 CDI 2.2 P-Van Dsl (W639)	04 on	Rear	←→	
44085	Technomatic		1	2	BMW	3 Series	E30 Series (Excl. iS & Cabriolet)	83-90	Front	←→	
44217	Technomatic		1	2	Nissan	1/2 Ton Bakkie	120Y (12" wheels)	76-83	Front	←→	
					Nissan	1/2 Ton Bakkie	1400, 1200, 120Y	71-08	Front	←→	
					Nissan	Y' Series	1200	71-75	Front	←→	
					Nissan	Y' Series	1200	72-75	Front	←→	
					Nissan	Y' Series	120Y, 140 SDX, (12" wheels)	75-80	Front	←→	
44226	Technomatic		1	2	Toyota	1200	LDV	78-82	Front	←→	
44227	Technomatic		1	2	Nissan	Langley, Pulsar	Incl. Panache (N10)	80-83	Front	←→	
44411	Technomatic		1	2	Opel	Astra	Estate (F)	94-01	Front	←→	
					Opel	Astra	F	93-99	Front	←→	
					Opel	Kadett	Astra	93-99	Front	←→	
44500	Technomatic		1	2	Nissan	U' Series	1600, 1800 (Incl. Coupe)	72-73	Front	←→	
					Nissan	U' Series	160U, 180U	74-78	Front	←→	



Part #	Range	Superceding Part #/Status	Product Type	Make	Model	Derivative	Year	Position	L/R	Note # (pg 6)
44505	Technomatic		/ 2	Ford	Escort	Mk I	68-73	Front	↔	
				Ford	Escort	Mk I 1100, 1300	70-75	Front	↔	
				Ford	Escort	Mk I, II	74-81	Front	↔	
				Ford	Escort	Mk II	75-81	Front	↔	17
44510	Technomatic		/ 2	Nissan	1/2 Ton Bakkie	1400 (13" wheels)	80-83	Front	↔	
				Nissan	Stanza	1600J, 1800J Stanza, Resort (A10)	78-83	Front	↔	
				Nissan	Stanza	1600J, 1800J, Stanza S/W (A10)	79-83	Front	↔	
				Nissan	Y' Series	140 SDX (13" wheels), 140Y, 160Y	75-80	Front	↔	
				Nissan	Y' Series	140Y, 160Y	75-80	Front	↔	
				Nissan	Y' Series	140Y, 160Y	75-80	Front	↔	
44511	Technomatic		/ 2	Volkswagen	Golf	Incl. Sport (Serviceable Strut) (Typ 14)	81-93	Front	↔	
				Volkswagen	Golf	Mk I (Local Strut)	79-84	Front	↔	
				Volkswagen	Jetta	Mk I (Local Strut)	79-85	Front	↔	
44516	Technomatic		/ 2	Ford	Capri	Mk I	69-73	Front	↔	
				Ford	Escort	Mk I 1600, GT	70-75	Front	↔	
44535	Technomatic		/ 2	Mazda	323	RWD (Local Strut)	78-81	Front	↔	
44554	Technomatic	55811	/ 1,1	Volkswagen	Golf	Mk II (Serviceable Strut)	84-92	Front	↔	
				Volkswagen	Jetta	Mk II	85-92	Front	↔	
44601	Technomatic		/ 2	BMW	5 Series	E12 Series	74-76	Front	↔	
				BMW	5 Series	E12 Series	76-85	Front	↔	18
44602	Technomatic		/ 2	Audi	80	B1	75-81	Front	↔	
				Volkswagen	Passat	B1	74-81	Front	↔	
				Volkswagen	Passat	B2	82-87	Front	↔	
44603	Technomatic		/ 2	Toyota	Cressida	MX63 (Mk II)	81-93	Front	↔	
				Toyota	Cressida	Non IRS+, MX63 (Mk II)	81-93	Front	↔	
				Toyota	Cressida	With IRS+, MX73 (Mk III)	83-93	Front	↔	
44604	Technomatic		/ 2	Peugeot	504	GL, GLD, Ti	73-80	Front	↔	
				Peugeot	504	L, GR	76-85	Front	↔	
44606	Technomatic		/ 2	Peugeot	504	Estate	74-85	Front	↔	
				Peugeot	505	Saloon	80-85	Front	↔	
44607	Technomatic		/ 2	Daewoo	Cielo	Nexia	95-98	Front	↔	
				Daewoo	Espero	Aranos	95-98	Front	↔	
				Daewoo	Lanos	Sens	97-03	Front	↔	
				Opel	Kadett	D	80-85	Front	↔	
				Opel	Kadett	Estate (D)	80-85	Front	↔	
				Opel	Kadett	T-car (E)	85-89	Front	↔	
				Opel	Kadett	T-car (E)	89-93	Front	↔	
				Opel	Monza	Incl. Cub	89-93	Front	↔	
				Opel	Monza	Incl. GSi	86-89	Front	↔	

44505 - 44607



44608





PARTS LISTING

Shocks & Struts

44608 - 51021

Part #	Range	Superceding Part#/Status	Product Type	Make	Model	Derivative	Year	Position	L/R	Note # (pg 6)
44608	Technomatic		/ 2	Nissan	Laurel	C230	78-87	Front	←→	
				Nissan	Skyline	1800, 2000 (R30)	82-87	Front	←→	
				Nissan	Skyline	2800 GLX, GTX (R30)	82-87	Front	←→	
44611	Technomatic		/ 2	Opel	Commodore	C	78-88	Front	←→	
				Opel	Commodore	C	78-92	Front	←→	
				Opel	Rekord	380i V6	91-97	Front	←→	
				Opel	Rekord	Caravan (E)	78-92	Front	←→	
				Opel	Rekord	Sedan (Excl. V6) (E)	78-97	Front	←→	
				Opel	Senator	A	79-86	Front	←→	
44612	Technomatic		/ 2	Mitsubishi	Colt	Galant (Local Strut)	78-83	Front	←→	
44613	Technomatic		/ 2	Toyota	Cressida	X30, X32 (Local Strut) (Mk I)	79-81	Front	←→	
				Toyota	Cressida	X35, X36 (Local Strut) (Mk I)	79-81	Front	←→	
44614	Technomatic		/ 2	Toyota	Corolla	Imported Strut (E30, E40, E50, E60)	74-80	Front	←→	10
				Toyota	Corolla	Imported Strut (E30, E40, E50, E60)	82-85	Front	←→	
				Toyota	Corolla	RWD (Excl. Van, S/W) (E70)	80-85	Front	←→	
				Toyota	Corolla Carri	Local Strut (E30, E40, E50, E60)	79-89	Front	←→	
44615	Technomatic		/ 2	Chevrolet/Opel	Ascona, Chevir	Incl. Coupe (C)	82-85	Front	←→	
44616	Technomatic	61915	/ 2	Nissan	Skyline	R31	87-92	Front	←→	
45171	Technomatic	81469	⊘ 6,2	Chrysler	Valiant	Incl. Dodge SE, Chrysler L	60-81	Front	←→	
				Chrysler	Valiant	Rustler	72-78	Front	←→	
46001	Safari		⊘ 6,1	Toyota	Prado	90 SWB & 95 LWB	96-02	Front	←→	
46002	Safari		⊘ 6,1	Toyota	Prado	90 SWB & 95 LWB	96-02	Rear	←→	
46003	Safari		⊘ 6,2	Nissan	Navara	4x4 & 4x2 (D40)	05 on	Front	←→	
46004	Safari		⊘ 6,2	Mitsubishi	Pajero	V Series (Mk II)	91-99	Front	←→	
46005	Safari		⊘ 6,2	Mitsubishi	Pajero	V Series (Mk II)	91-99	Rear	←→	
51006	Technomatic		‡ 3,2	Volkswagen	Citi	Incl. Chicco (Excl. Sonic, Life & VeloCiti)	84 on	Rear	←→	9
				Volkswagen	Fox	Incl. Shuttle	87-95	Rear	←→	9
				Volkswagen	Golf	Mk I (Imported Strut)	78-79	Rear	←→	9
				Volkswagen	Golf	Mk I (Local Strut)	79-84	Rear	←→	9
				Volkswagen	Golf	Mk I (Local Strut)	79-84	Rear	←→	9
				Volkswagen	Jetta	Mk I (Imported Strut)	78-85	Rear	←→	9
				Volkswagen	Jetta	Mk I (Local Strut)	79-85	Rear	←→	9
				Volkswagen	Jetta	Mk I (Local Strut)	79-85	Rear	←→	9
51016	Technomatic		‡ 3,2	Volkswagen	Passat	B2	82-87	Rear	←→	9
51021	Technomatic	69067	‡ 3,2	Honda	Ballade	130, 150, 150i (SC9) (Civic)	84-87	Rear	←→	



Part #	Range	Superceding Part #/Status	Product Type	Make	Model	Derivative	Year	Position	L/R	Note # (pg 6)	
51022	Technomatic	69068	f	3,2	Volkswagen	Golf	Mk II (Serviceable Strut)	84-92	Rear	↔	
					Volkswagen	Golf	Mk III (Excl. VR6 & Cabriolet), Mk II All (Excl. Cabriolet)	93-94	Rear	↔	
					Volkswagen	Golf	Mk III All (Excl. Cabriolet)	95-99	Rear	↔	
					Volkswagen	Golf	Mk III GTi	94-99	Rear	↔	
					Volkswagen	Jetta	Mk II	85-92	Rear	↔	
					Volkswagen	Jetta	Mk III	95-99	Rear	↔	
					Volkswagen	Jetta	Mk III Cli	94-99	Rear	↔	
					Volkswagen	Jetta	Mk III (Excl. VR6), Mk II	93-94	Rear	↔	
51158	Technomatic	69074	f	3,2	Nissan	Laurel	C230	78-87	Rear	↔	
					Nissan	Skyline	1800, 2000 (R30)	82-87	Rear	↔	
51165	Technomatic	69072	f	3,2	Audi	400, 500	C3, C4	83-94	Rear	↔	
51168	Technomatic		f	3,2	Tata	Indica	1.4 Hatch (V2) (Incl. B-Line, Excl. TDi)	04 on	Rear	↔	
51240	Technomatic		o	6,1	Toyota	Prado	90 SWB & 95 LWB	96-02	Front	↔	
51309	Technomatic		f	3,2	BMW	5 Series	E12 Series	76-85	Rear	↔	18
55088	Safari		o	6,1	Ford	Triton 0510, 0610	Truck	85-87	Front	↔	
					Isuzu	SBR 422, FJR	Truck	76-83	Front	↔	
					Mitsubishi	Canter	Truck	80 on	Front	↔	
					Nissan	CM 10 F	Truck	87 on	Front	↔	
					Nissan	CM 8 F	Truck	87-95	Front	↔	
					Isuzu	Frontier	4x4, 4x2	98-02	Rear	↔	
					Leyland	FG 550, FG 420	Truck	68-77	Rear	↔	
					Ssangyong	Musso	602TDi, E230EL, E320EL	95-06	Rear	↔	
55208	Safari		±	4	Mercedes-Benz	114, 115 Series	220, 230, 240D, 280E, 280 (Excl. )	68-77	Rear	↔	
					Mercedes-Benz	C Class	(W123) 200, 230E, 240D, 250, 280E, 300D (Excl. )	77-86	Rear	↔	
					Mercedes-Benz	S Class	(116 Series) 280SE, 280S, 350SE (Excl. )	73-81	Rear	↔	
					Mercedes-Benz	S Class	(W126) 280SE, 300SE, 380SE, 420SE, 500SE, 560SE Incl. SEL & SEC (Excl. )	81-93	Rear	↔	
55210	Safari		o	8,5	Mercedes-Benz	0.309D	Bus	19...	Front	↔	
					Mercedes-Benz	L408, L508, L608	Truck	79 on	Front	↔	
					Mercedes-Benz	MB 800	Bus	19...	Front	↔	
					Mercedes-Benz	MB 800	Truck	19...	Front	↔	
					Mercedes-Benz	0.309D	Bus	19...	Rear	↔	
					Mercedes-Benz	608 LP, LPK, LPS, LPO	Truck	19...	Rear	↔	
					Mercedes-Benz	609, 811 LP, LPS, LPK	Truck	19...	Rear	↔	
					Mercedes-Benz	808 LP, LPS, LPK	Truck	19...	Rear	↔	
					Mercedes-Benz	L408, L508, L608	Truck	79 on	Rear	↔	

51022 - 55210



55211

PARTS LISTING

Shocks & Struts

55211 - 55801



Part #	Range	Superceding Part#/Status	Product Type	Make	Model	Derivative	Year	Position	L/R	Note # (pg 6)
55211	Safari		6,1	Ford	Triton 0608, 0610	Truck	87 on	Front	←→	
				Isuzu	FRR500	Truck	19...	Front	←→	
				Isuzu	N2800 P	Truck	93 on	Front	←→	29
				Isuzu	N3000 P	Truck	87-90	Front	←→	29
				Isuzu	NKR55/99	Truck	19...	Front	←→	29
				Isuzu	TL40-50	Truck	75 on	Front	←→	29
				Isuzu	TLD 24	Truck	77-88	Front	←→	29
				Isuzu	TLD44, TLD54	Truck	77-89	Front	←→	
				Mazda	T2000, 3000	LDV	83 on	Front	←→	
				Mazda	T2000, T3000	Truck	81-86	Front	←→	
55227	Safari		6,2	Volkswagen	Kombi	Microbus (Excl. Synchro 4x4)	80-02	Front	←→	12
55231	Safari		6,2	Tata	Telcoline	4x4, 4x2	04 on	Front	←→	
55232	Safari		8,5	Tata	LPT 509M 4x2 F-C	Truck	19...	Rear	←→	
				Tata	SFC 407 2T 4x2 F-C	Truck	19...	Rear	←→	
55233	Safari		8,5	Tata	LPT 709 3T 4x2 F-C	Truck	19...	Front	←→	
				Tata	LPT 713 S 4x2 F-C	Truck	19...	Front	←→	
				Tata	LPT 713 S Chassis 4x2 Bus	Truck	19...	Front	←→	
55234	Safari		8,5	Tata	LPT 709 3T 4x2 F-C	Truck	19...	Rear	←→	
				Tata	LPT 713 S 4x2 F-C	Truck	19...	Rear	←→	
				Tata	LPT 713 S Chassis 4x2 Bus	Truck	19...	Rear	←→	
55236	Safari		6,2	Nissan	UD 35	4x2 F-C	96-10	Front	←→	
				Nissan	UD 35A	4x2 F-C	96-10	Front	←→	
				Nissan	UD 40L	Truck	96 on	Front	←→	
55237	Safari		8,2	Nissan	UD 40L	Truck	96 on	Rear	←→	
55238	Safari		6,1	Toyota	Dyna	7-145	08 on	Front	←→	
55239	Safari		8,2	Toyota	Dyna	7-105	03-on	Rear	←→	
				Toyota	Dyna	7-145	08 on	Rear	←→	
				Toyota	Dyna	8-145	03-on	Rear	←→	
55240	Safari		8,2	Isuzu	N Series	NQR500T & NPR400	98-06	Rear	←→	
55241	Safari		8,2	Toyota	Dyna	5-103 4x2	19...	Rear	←→	
55242	Safari		8,2	Isuzu	N Series	N4000D & N3500D	88-99	Rear	←→	
55243	Safari		8,5	Isuzu	N Series	NPR 300, 400	84-03	Front	←→	
55800	Gas Ryder	35842	1,1	Ford	Sierra, Sapphire	2300, 2000, 1600	83-93	Front	←→	
				Ford	Sierra, Sapphire	3000 (Incl. XR6)	83-93	Front	←→	
				Ford	Sierra, Sapphire	Estate	83-93	Front	←→	
55801	Gas Ryder	35816	1,1	Ford	Escort	Mk III FWD L, GL, GLE	81-86	Front	←→	
				Ford	Escort	Mk III FWD XR3, Sport	81-86	Front	←→	

PARTS LISTING

Shocks & Struts

55802



Part #	Range	Superceding Part #/Status	Product Type	Make	Model	Derivative	Year	Position	L/R	Note # (pg 6)
55802	Gas Ryder		1,2	Ford	Escort	Mk III FWD L, GL, GLE	81-86	Rear	↔	
				Ford	Escort	Mk III FWD XR3, Sport	81-86	Rear	↔	
55803	Gas Ryder		1,1	Mazda	323	Incl. S, EGi, Sport	82-91	Front	↔	
55804	Gas Ryder		1,1	Ford	Laser, Meteor, Tracer	KC/KE, GC	86-91	Rear	↔	
				Ford	Laser, Meteor, Tracer	KF/KH	91-01	Rear	↔	
				Mazda	323	(Familia) Incl. Midge & Sting	91-04	Rear	↔	
				Mazda	323	Incl. S, EGi, Sport	82-91	Rear	↔	
55806	Gas Ryder		1,1	Mazda	626	Incl. Coupe (Mk II, Mk III)	83-92	Front	↔	
55807	Gas Ryder		1,1	Mazda	626	Incl. Coupe (Mk II, Mk III)	83-92	Rear	↔	
55810	Gas Ryder		1,1	Honda	Ballade	130, 150, 150i (SC9) (Civic)	84-87	Front	↔	
55811	Gas Ryder		1,1	Volkswagen	Golf	Mk II (Serviceable Strut)	84-92	Front	↔	
				Volkswagen	Golf	Mk III (Excl. VR6 & Cabriolet), Mk II All (Excl. Cabriolet)	93-94	Front	↔	
				Volkswagen	Jetta	Mk II	85-92	Front	↔	
				Volkswagen	Jetta	Mk III (Excl. VR6), Mk II	93-94	Front	↔	
55812	Gas Ryder		1,1	Toyota	Conquest	FWD (E80)	85-89	Front	↔	
				Toyota	Corolla	FWD (Incl. Avante) (E80)	85-89	Front	↔	
55813	Gas Ryder		1,1	Toyota	Conquest	FWD (E80)	85-89	Rear	↔	
				Toyota	Corolla	FWD (Incl. Avante) (E80)	85-89	Rear	↔	
55815	Gas Ryder		1,1	Mercedes-Benz	C Class	(W201) 190E (Excl. )	83-94	Front	↔	
				Mercedes-Benz	C Class	(W124) 200, 230E, 260E, 300D, 300E (Excl. )	86-95	Front	↔	
55816	Gas Ryder		1,1	Nissan	Sentra	Sedan, Coupe (B12)	87-92	Front	↔	
55817	Gas Ryder		1,1	Nissan	Sentra	Sedan, Coupe (B12)	87-92	Rear	↔	
55818	Gas Ryder		1,1	Toyota	Conquest	FWD (E90)	85-88	Front	↔	
				Toyota	Corolla	FWD (E90)	89-96	Front	↔	
				Toyota	Corolla Carri	E90	98-05	Front	↔	
				Toyota	Tazz	FWD (E90)	96-07	Front	↔	
55819	Gas Ryder		1,1	Toyota	Conquest	FWD (E90)	85-88	Rear	↔	
				Toyota	Corolla	FWD (E90)	89-96	Rear	↔	
				Toyota	Corolla Carri	E90	98-05	Rear	↔	
				Toyota	Tazz	FWD (E90)	96-07	Rear	↔	
55825	Gas Ryder		1,1	Ford	Laser, Meteor, Tracer	KF/KH	91-01	Front	↔	
				Mazda	323	(Familia) Incl. Midge & Sting	91-04	Front	↔	
55833	Gas Ryder		1,1	Volkswagen	Citi	Incl. Chico (Excl. Sonic, Life & VeloCiti)	84 on	Front	↔	
				Volkswagen	Citi	Sonic, Life & VeloCiti	98 on	Front	↔	
				Volkswagen	Fox	Incl. Shuttle	87-95	Front	↔	
				Volkswagen	Golf	Mk I (Local Strut)	79-84	Front	↔	
				Volkswagen	Golf	Pickup (sealed Strut)	93-03	Front	↔	
				Volkswagen	Jetta	Mk I (Local Strut)	79-85	Front	↔	

55802 - 55833



55834

PARTS LISTING

Shocks & Struts

55834 - 55856

Part #	Range	Superceding Part#/Status	Product Type	Make	Model	Derivative	Year	Position	L/R	Note # (pg 6)
55834	Gas Ryder		1,1	BMW	3 Series	E36 Series (Excl. M3)	91-99	Front	L	
				BMW	3 Series	E36 Series Cabriolet	93-99	Front	L	
55835	Gas Ryder		1,1	BMW	3 Series	E36 Series (Excl. M3)	91-99	Front	R	
				BMW	3 Series	E36 Series Cabriolet	93-99	Front	R	
55838	Gas Ryder		1,1	Nissan	Sabre	160, 200 (Excl. ABS)	92-01	Front	L	
				Nissan	Sentra	140	92-01	Front	L	
				Nissan	Sentra	160, 200 (Excl. STi)	92-01	Front	L	
55839	Gas Ryder		1,1	Nissan	Sabre	160, 200 (Excl. ABS)	92-01	Front	R	
				Nissan	Sentra	140	92-01	Front	R	
				Nissan	Sentra	160, 200 (Excl. STi)	92-01	Front	R	
55840	Gas Ryder		1,1	Nissan	Sentra	140	92-01	Rear	←→	
55841	Gas Ryder		1,1	Volkswagen	Golf	Mk III All (Excl. Cabriolet)	95-99	Front	←→	
				Volkswagen	Golf	Mk III GTi	94-99	Front	←→	
				Volkswagen	Golf	Mk III VR6	93-99	Front	←→	
				Volkswagen	Jetta	Mk III	95-99	Front	←→	
				Volkswagen	Jetta	Mk III Cli	94-99	Front	←→	
				Volkswagen	Jetta	Mk III VR6	93-99	Front	←→	
				Volkswagen	Polo	Classic (Mk III)	96-02	Front	←→	
				Volkswagen	Polo	Playa (9N)	98-02	Front	←→	
55843	Gas Ryder		1,1	Ford	Telstar	Incl. TX5	93-99	Front	L	
				Mazda	626	2.0, 2.5 (Incl. MX-6) (Mk IV)	92-98	Front	L	
55844	Gas Ryder		1,1	Ford	Telstar	Incl. TX5	93-99	Front	R	
				Mazda	626	2.0, 2.5 (Incl. MX-6) (Mk IV)	92-98	Front	R	
55845	Gas Ryder		1,1	Ford	Telstar	Incl. TX5	93-99	Rear	←→	
				Mazda	626	2.0, 2.5 (Incl. MX-6) (Mk IV)	92-98	Rear	←→	
55846	Gas Ryder		1,1	Toyota	Camry	XV10	93-97	Front	L	
55847	Gas Ryder		1,1	Toyota	Camry	XV10	93-97	Front	R	
55848	Gas Ryder		1,1	Toyota	Camry	XV10	93-97	Rear	L	
				Toyota	Camry	SV20	96-01	Rear	L	
				Toyota	Camry	XV20	97-01	Rear	L	
55849	Gas Ryder		1,1	Toyota	Camry	XV10	93-97	Rear	R	
				Toyota	Camry	SV20	96-01	Rear	R	
				Toyota	Camry	XV20	97-01	Rear	R	
55854	Gas Ryder		1,1	Fiat	Uno	Incl. Turbo (Series 2)	90-06	Front	←→	
				Fiat	Uno	P-Van (Series 2)	90-06	Front	←→	
55855	Gas Ryder		1,1	Nissan	Sabre	160, 200 (Excl. ABS)	92-01	Rear	L	
				Nissan	Sentra	160, 200 (Excl. STi)	92-01	Rear	L	
55856	Gas Ryder		1,1	Nissan	Sabre	160, 200 (Excl. ABS)	92-01	Rear	R	
				Nissan	Sentra	160, 200 (Excl. STi)	92-01	Rear	R	



Part #	Range	Superceding Part #/Status	Product Type	Make	Model	Derivative	Year	Position	L/R	Note # (pg 6)
55858	Gas Ryder		1,1	Opel	Corsa	(B) Utility	96-04	Front	↔	
				Opel	Corsa	B	96-02	Front	↔	
				Opel	Corsa	Corsa Lite (B)	02-07	Front	↔	
55861	Gas Ryder		1,1	Toyota	Corolla	Excl. Rsi (E100)	96-02	Front	↔	
				Toyota	Corolla	RSi (E100)	96-02	Front	↔	
55863	Gas Ryder		1,1	Toyota	Corolla	Excl. Rsi (E100)	96-02	Rear	↔	
55865	Gas Ryder		1,1	Ford	Fiesta	Mark IV (Excl. 1.6 Rsi 3-door) (Sleeve eye)	99-03	Front	↔	
				Ford	Fiesta	Mark IV (Excl. 1.6 Rsi 3-door) (U Bracket)	97-99	Front	↔	
				Ford	Ikon	B3 (Sleeve eye)	00-06	Front	↔	
				Ford	Ikon	B3 (U Bracket)	00-06	Front	↔	
				Mazda	Soho	121 (Bracket)	97-99	Front	↔	23
				Mazda	Soho	121 (Eye)	97-99	Front	↔	22
55868	Gas Ryder		1,1	Hyundai	Accent	X3	94-97	Rear	↔	
55869	Gas Ryder		1,1	Hyundai	Accent	X3	94-97	Front	↔	
				Hyundai	Accent	X3	98-00	Front	↔	
55870	Gas Ryder		1,1	Hyundai	Accent	X3	98-00	Rear	↔	
55872	Gas Ryder		1,1	Audi	A3	Excl. S3 (8L1)	98-03	Front	↔	
				Volkswagen	Beetle	Mk II	99 on	Front	↔	
				Volkswagen	Golf	Mk IV 1.8, GTi, 1.9 TDi, 2.0, 2.3V5	99-04	Front	↔	
				Volkswagen	Golf	Mk IV 1.8, GTi, 1.9 TDi, 2.0, 2.3V5 (with 22mm Strut rod)	99-04	Front	↔	
				Volkswagen	Jetta	Mk IV (with 22mm Strut rod)	99-06	Front	↔	
55881	Gas Ryder		1,1	Volkswagen	Golf	Mk IV 1.6	99-04	Front	↔	
				Volkswagen	Golf	Mk IV 1.6 (with 20mm Strut rod)	99-04	Front	↔	
				Volkswagen	Jetta	Mk IV 1.6 (with 20mm Strut rod)	99-06	Front	↔	
55886	Gas Ryder		1,1	Toyota	Camry	XV20	97-01	Front	L	
55887	Gas Ryder		1,1	Toyota	Camry	XV20	97-01	Front	R	
55888	Gas Ryder		1,1	Mazda	Etude	1.6 litre (BJ)	10.02-04	Front	L	
55889	Gas Ryder		1,1	Mazda	Etude	1.6 litre (BJ)	10.02-04	Front	R	
55890	Gas Ryder		1,1	Mazda	Etude	1.6 litre (BJ)	00-09.02	Rear	L	
				Mazda	Etude	1.6 litre (BJ)	10.02-04	Rear	L	
55891	Gas Ryder		1,1	Mazda	Etude	1.6 litre (BJ)	00-09.02	Rear	R	
				Mazda	Etude	1.6 litre (BJ)	10.02-04	Rear	R	
55892	Gas Ryder		1,1	Toyota	Corolla	E120, E130	02-07	Front	L	
				Toyota	RunX	E120, E130	02-07	Front	L	

55858 - 55892



55893

PARTS LISTING

Shocks & Struts

55893 – 61235

Part #	Range	Superceding Part#/Status	Product Type	Make	Model	Derivative	Year	Position	L/R	Note # (pg 6)
55893	Gas Ryder		1,1	Toyota	Corolla	E120, E130	02-07	Front	R	
				Toyota	RunX	E120, E130	02-07	Front	R	
61200	Gas Ryder	G45839	6,2	Chevrolet/Opel	Ascona, Chevailr	Incl. Coupe (C)	82-85	Rear	←→	
				Chevrolet/Opel	Ascona, Chevailr	Incl. Coupe (short Strut) (C)	84-86	Rear	←→	
				Opel	Kadett	D	80-85	Rear	←→	
				Opel	Kadett	T-car (E)	85-89	Rear	←→	
				Opel	Monza	Incl. GSi	86-89	Rear	←→	
61201	Gas Ryder		7,1	Mercedes-Benz	114, 115 Series	220, 230, 240D, 280E, 280 (Excl.)	68-77	Front	←→	
				Mercedes-Benz	SL Class	280 SL, SLC, 350 SL, SLC (Excl.)	71-81	Front	←→	
				Mercedes-Benz	SL Class	450 SL, SLC (Excl.)	73-81	Front	←→	
61202	Gas Ryder		7,1	Mercedes-Benz	E Class	(W123) 200, 230E, 240D, 250, 280E, 300D (Excl.)	77-87	Front	←→	
				Mercedes-Benz	S Class	(116 Series) 280SE, 280S, 350SE (Excl.)	73-81	Front	←→	
				Mercedes-Benz	S Class	(W126) 280SE, 300SE, 380SE, 420SE, 500SE, 560SE Incl. SEL & SEC (Excl.)	81-93	Front	←→	
61212	Gas Ryder		6,1	Toyota	Cressida	With IRS+, MX73 (Mk III)	83-93	Rear	←→	
61213	Gas Ryder	G45503	10	Ford	Cortina	Mk III	71-77	Front	←→	
				Ford	Cortina	Mk III, IV	71-78	Front	←→	
				Ford	Cortina	Mk IV	77-80	Front	←→	
				Ford	Cortina	Mk IV	78-80	Front	←→	
61214	Gas Ryder	G45520	8,5	Ford	Cortina	Mk III	71-77	Rear	←→	
				Ford	Cortina	Mk IV	77-80	Rear	←→	
				Ford	Cortina	Mk V	80-83	Rear	←→	
61228	Gas Ryder		6,1	Toyota	Celica, Supra	A60 Series (Mk III)	81-85	Rear	←→	
				Toyota	Cressida	Non IRS+, MX63 (Mk II)	81-93	Rear	←→	
				Toyota	Cressida	X30, X32 (Imported Strut) (Mk I)	77-79	Rear	←→	
				Toyota	Cressida	X30, X32 (Local Strut) (Mk I)	79-81	Rear	←→	
61230	Gas Ryder		6,1	Opel	Rekord	380i V6	91-97	Rear	←→	
				Opel	Senator	A	79-86	Rear	←→	
61232	Gas Ryder	G45837	10	Ford	Cortina	Mk V	80-83	Front	←→	
				Ford	Cortina	Mk V	80-82	Front	←→	
				Ford	Cortina	Mk V	80-83	Front	←→	
				Ford	Cortina	Mk V	83-86	Front	←→	
61233	Gas Ryder	G45838	6,2	Ford	Cortina	Mk V	80-83	Rear	←→	
61234	Gas Ryder	G45212	4	Opel	2500, 3800, 4100	2.5, 3.8, & 4.1 Estate	75-78	Front	←→	
				Opel	2500, 3800, 4100	2.5, 3.8, & 4.1 Sedan	73-78	Front	←→	
				Opel	Rekord	C	67-73	Front	←→	
61235	Gas Ryder	G45841	6,1	Toyota	Corolla	RWD (Excl. Van, S/W) (E70)	80-85	Rear	←→	
				Toyota	Corona	Mk I	74-80	Rear	←→	



Part #	Range	Superceding Part #/Status	Product Type	Make	Model	Derivative	Year	Position	L/R	Note # (pg 6)
61238	Gas Ryder	G45860	8,5	Ford	Sierra, Sapphire	2300, 2000, 1600	83-93	Rear	↔	
				Ford	Sierra, Sapphire	3000 (Incl. XR6)	83-93	Rear	↔	
61239	Gas Ryder	36857	6,2	BMW	3 Series	E30 Series (Excl. iS & Cabriolet)	83-91	Rear	↔	
61241	Gas Ryder		6,2	Fiat	Uno	Incl. Turbo (Series 2)	90-06	Rear	↔	
				Fiat	Uno	P-Van (Series 2)	90-06	Rear	↔	
61242	Gas Ryder	G45874	6,2	Daewoo	Cielo	Nexia	95-98	Rear	↔	
				Daewoo	Espero	Aranos	95-98	Rear	↔	
				Daewoo	Lanos	Sens	97-03	Rear	↔	
				Opel	Astra	F	93-99	Rear	↔	
				Opel	Kadett	Astra	93-99	Rear	↔	
				Opel	Kadett	T-car (E)	89-93	Rear	↔	
Opel	Monza	Incl. Cub	89-93	Rear	↔					
61243	Gas Ryder	G45858	4	Ford	Sierra, Sapphire	Estate	83-93	Rear	↔	
61248	Gas Ryder		6,2	BMW	3 Series	E36 Series (Excl. M3)	91-99	Rear	↔	
				BMW	3 Series	E36 Series (Imported 4 cyl. Models)	91-99	Rear	↔	
				BMW	3 Series	E36 Series (Imported 6 cyl. Models)	91-99	Rear	↔	
				BMW	3 Series	E36 Series (Imported Excl. M-Series) 320i, 325i, 325td (long Stud)	91-92	Rear	↔	
				BMW	3 Series	E36 Series Cabriolet	93-99	Rear	↔	
				BMW	3 Series	E46 Series (Excl. M3, + Touring) one pin at the bottom Strut mounting	99-05	Rear	↔	
61252	Gas Ryder		9,2	Opel	Astra	Estate (F)	94-01	Rear	↔	7
				Opel	Kadett	Estate (D)	80-85	Rear	↔	7
61253	Gas Ryder		6,2	Mercedes-Benz	C Class	(W202) C180, C200, C220, C230, C250 (Excl. C280 & Sport Susp.)	94-00	Front	↔	
61254	Gas Ryder		6,2	Mercedes-Benz	C Class	(W202) C180, C200, C220, C230, C250, C280 (Excl. Sport Susp.)	94-00	Rear	↔	
61256	Gas Ryder		6,2	Opel	Corsa	B	96-02	Rear	↔	
				Opel	Corsa	Corsa Lite (B)	02-07	Rear	↔	
				Opel	Corsa	Excl. Corsa Lite (C)	02-07	Rear	↔	
61257	Gas Ryder		8,5	Opel	Corsa	(B) Utility	96-04	Rear	↔	
61262	Gas Ryder		6,2	Audi	A3	Excl. S3 (8L1)	98-03	Rear	↔	
				Volkswagen	Beetle	Mk II	99 on	Rear	↔	
				Volkswagen	Golf	Mk IV 1.6 (with 20mm Strut rod)	99-04	Rear	↔	
				Volkswagen	Golf	Mk IV 1.8, GTi, 1.9 TDi, 2.0, 2.3V5 (with 22mm Strut rod)	99-04	Rear	↔	
				Volkswagen	Jetta	Mk IV (with 22mm Strut rod)	99-06	Rear	↔	
				Volkswagen	Jetta	Mk IV 1.6 (with 20mm Strut rod)	99-06	Rear	↔	
61270	Gas Ryder		6,2	Fiat	Palio	Type 1X	00-02	Rear	↔	
				Fiat	Siena	Type 2A	00-02	Rear	↔	
61281	Technomatic		8,2	Mahindra	Bolero	4x4	05 on	Rear	↔	

61238 - 61281



Part #	Range	Superceding Part#/Status	Product Type	Make	Model	Derivative	Year	Position	L/R	Note # (pg 6)
61282	Technomatic		⊖ 6,2	Mahindra	Bolero	4x4	05 on	Front	↔	
61283	Technomatic		⊖ 4	Mahindra	Scorpio	4x2	05 on	Front	↔	
61285	Gas Ryder		⊖ 6,2	Hyundai	Getz	3 & 5-door	03 on	Rear	↔	
61286	Gas Ryder		⊖ 6,2	Peugeot	307	1.6, 2.0 Excl. CC	01-08	Rear	↔	
61287	Gas Ryder		⊖ 6,2	Hyundai	Terracan	2.9, 3.5	01-09	Front	↔	
61288	Gas Ryder		⊖ 6,2	Hyundai	Terracan	2.9, 3.5	01-09	Rear	↔	
61289	Gas Ryder		⊖ 6,2	Hyundai	Santa FE	SM	01-06	Rear	↔	
61292	Gas Ryder		⊖ 6,2	BMW	X5	E53 3.0i, 3.0d, 4.4iV8, 4.8 V8 4x4	01-07	Rear	↔	
61293	Gas Ryder		⊖ 6,2	Volkswagen	Golf	Mk V 1.6l	04-09	Rear	↔	
				Volkswagen	Golf	Mk V 1.9T Di, 2.0 FSi	04-09	Rear	↔	
				Volkswagen	Golf	Mk VI (Excl. GTi, V5, R32, AWD & Sport Susp.)	09 on	Rear	↔	
61294	Gas Ryder		⊖ 8,5	Mercedes-Benz	Vito	112 CDI Bus	03-04	Rear	↔	
				Mercedes-Benz	Vito	112 CDI 2.2 Cr-Cab P-Van Dsl	03	Rear	↔	
				Mercedes-Benz	Vito	112 CDI 2.2 P-Van Dsl	02-04	Rear	↔	
61295	Gas Ryder		⊖ 13,2	Kia	Rio	1.3 & 1.6 (DC)	00-03	Rear	↔	
61296	Gas Ryder		⊖ 6,2	Honda	Jazz	1.4Dsi, 1.5 Gen 1	03-07	Rear	↔	
61297	Gas Ryder		⊖ 6,2	Toyota	Corolla	1.3, 1.4, 1.6 & 1.8 (E140, E150)	07 on	Rear	↔	
				Toyota	Corolla	2.0 D4D (E140, E150)	07 on	Rear	↔	
61298	Gas Ryder		⊖ 6,2	Audi	A4	Excl. Sport Susp. (B6)	01-05	Rear	↔	
61299	Gas Ryder		⊖ 6,2	Ford	Fiesta	Mark V Hatch & Sedan	02-08	Rear	↔	
				Ford	Figo	1.4	10 on	Rear	↔	
				Ford	Ikon	Sedan All	07 on	Rear	↔	
				Mazda	Demio	Hatch DY	02-07	Rear	↔	
				Mazda	Mazda 2	Hatch DY (Demio)	02-07	Rear	↔	
61302	Gas Ryder		/ 2	BMW	5 Series	E34 Series (Excl. M5)	89-96	Front	↔	
				BMW	7 Series	E32 Series	87-94	Front	↔	
61303	Gas Ryder		/ 2	Audi	100, 200	C2	77-84	Front	↔	
				Audi	400, 500	C3, C4	83-94	Front	↔	
				Audi	A6	Incl. Avant. Excl. Quattro (C4)	94-97	Front	↔	
				Volkswagen	Golf	Incl. Sport (Serviceable Strut) (Typ 14)	81-93	Front	↔	
61404	Gas Ryder	44085	/ 2	BMW	3 Series	E30 Series (Excl. iS & Cabriolet)	83-91	Front	↔	
61900	Gas Ryder	44611	/ 2	Opel	Commodore	C	78-88	Front	↔	
				Opel	Commodore	C	78-92	Front	↔	
				Opel	Rekord	380i V6	91-97	Front	↔	
				Opel	Rekord	Caravan (E)	78-92	Front	↔	
				Opel	Rekord	Sedan (Excl. V6) (E)	78-97	Front	↔	
				Opel	Senator	A	79-86	Front	↔	

PARTS LISTING

Shocks & Struts

61901



61901 – 62008

Part #	Range	Superceding Part #/Status	Product Type	Make	Model	Derivative	Year	Position	L/R	Note # (pg 6)
61901	Gas Ryder	44614	/ 2	Toyota	Corolla	Imported Strut (E30, E40, E50, E60)	82-85	Front	↔	
				Toyota	Corolla	RWD (Excl. Van, S/W) (E70)	80-85	Front	↔	
61902	Gas Ryder	44601	/ 2	BMW	5 Series	E12 Series	74-76	Front	↔	
				BMW	5 Series	E12 Series	76-85	Front	↔	
61903	Gas Ryder		/ 2	Toyota	Cressida	MX63 (Mk II)	81-93	Front	↔	
				Toyota	Cressida	Non IRS+, MX63 (Mk II)	81-93	Front	↔	
				Toyota	Cressida	With IRS+, MX73 (Mk III)	83-93	Front	↔	
61904	Gas Ryder	44608	/ 2	Nissan	Laurel	C230	78-87	Front	↔	
				Nissan	Skyline	1800, 2000 (R30)	82-87	Front	↔	
				Nissan	Skyline	2800 GLX, GTX (R30)	82-87	Front	↔	
61909	Gas Ryder		/ 2	Daewoo	Cielo	Nexia	95-98	Front	↔	
				Daewoo	Espero	Aranos	95-98	Front	↔	
				Daewoo	Lanos	Sens	97-03	Front	↔	
				Opel	Kadett	D	80-85	Front	↔	
				Opel	Kadett	Estate (D)	80-85	Front	↔	
				Opel	Kadett	T-car (E)	85-89	Front	↔	
				Opel	Kadett	T-car (E)	89-93	Front	↔	
				Opel	Monza	Incl. Cub	89-93	Front	↔	
Opel	Monza	Incl. GSi	86-89	Front	↔					
61914	Gas Ryder		/ 2	BMW	5 Series	E28 Series (Excl. M5)	85-89	Front	↔	
61915	Gas Ryder		/ 2	Nissan	Skyline	R31	87-92	Front	↔	
61918	Gas Ryder		/ 2	Opel	Astra	Estate (F)	94-01	Front	↔	
				Opel	Astra	F	93-99	Front	↔	
				Opel	Kadett	Astra	93-99	Front	↔	
62000	Gas Ryder		1/2 6,2	Kia	Picanto	Mk 1 Incl. 2007 & 2010 facelift (SA)	04-11	Rear	↔	
62001	Gas Ryder		1/2 6,2	Nissan	Micra	5-Door (K12)	04 on	Rear	↔	
62002	Gas Ryder		1/2 6,2	Volkswagen	Golf	Mk V 2.0 GTi	04-09	Rear	↔	
62003	Gas Ryder		1/2 6,2	Audi	A4	Sport Susp. Incl. Avant & Quattro (Excl. AllRoad, S4 & RS4) B7 model	05-08	Rear	↔	
62004	Gas Ryder		1/2 6,2	Mercedes-Benz	C Class	(W203) C180, C200, C220 CDI, C230, C270 CDI, C280, C320 CDI, C350	00-07	Rear	↔	
62005	Gas Ryder		1/2 6,2	Fiat	Palio	Expresso P-Van	01 on	Rear	↔	
				Fiat	Palio	Type 2H	01 on	Rear	↔	
62006	Gas Ryder		1/2 6,2	Nissan	Tiida	1.6i & 1.8i Hatch & Sedan	06 on	Rear	↔	
62007	Gas Ryder		1/2 1,1	Volkswagen	Kombi	T5 Kombi, Caravelle (Excl. 4-Motion)	04 on	Rear	↔	
				Volkswagen	Kombi	T5 Transporter: Crew bus, Pickup & P-Van (Excl. 4-Motion)	05 on	Rear	↔	
62008	Gas Ryder		1/2 8,2	Mercedes-Benz	Sprinter	P-Van	06 on	Rear	↔	
				Volkswagen	Crafter	3 Ton, 3, 5 Ton (Excl. 4x4 & 5 Ton) (LT3)	06 on	Rear	↔	



62009

PARTS LISTING

Shocks & Struts

62009 – 62044



Part #	Range	Superceding Part#/Status	Product Type		Make	Model	Derivative	Year	Position	L/R	Note # (pg 6)
62009	Gas Ryder		1/2	6,2	Ford	Fiesta	Mk VI	08 on	Rear	←→	
					Mazda	Mazda 2	DE (Demio)	07 on	Rear	←→	
62010	Gas Ryder		0	8,5	Volkswagen	Civic	50mm OD & 55mm OD struts	04 on	Rear	←→	
62011	Gas Ryder		1/2	6,2	Honda	Civic	Mk VIII	06 on	Rear	←→	
62012	Gas Ryder		1/2	6,2	Nissan	NP200	1.5, 1.6	08 on	Rear	←→	
62013	Gas Ryder		1/2	6,2	Mercedes-Benz	E-Class (W211)	E200K, E220 CDI, E240, E270CDi, E280, E320CDi, E350, E500, E320 (Excl. S/W, AMG, Elec. & Air Susp.)	02-09	Rear	←→	
62014	Gas Ryder		0	8,5	Toyota	Rav 4	XA30	06 on	Rear	←→	
62015	Gas Ryder		0	13,2	Kia	Rio	1.3 & 1.6 (DC)	03-06	Rear	←→	
62016	Gas Ryder		1/2	6,2	Hyundai	Accent	MC. 1.6	05-11	Rear	←→	
62018	Gas Ryder		1/2	6,2	Volkswagen	Jetta	Mk V	06 on	Rear	←→	
					Volkswagen	Jetta	6 Sedan	11 on	Rear	←→	
62019	Gas Ryder		0	8,5	Opel	Astra	(H) 1.8 & 1.9 CDTi Incl. GTC (Excl. 2.0 Turbo Sport & OPC)	04-09	Rear	←→	
62020	Gas Ryder		1/2	6,1	Toyota	Rav4	XA20 (Mk II)	01-06	Rear	←→	
62021	Gas Ryder		1/2	6,2	BMW	X3	E83 2.5, 3.0 & 2.0D	04-10	Rear	←→	
62022	Gas Ryder		1/2	6,2	Toyota	Auris	1.4, 1.6, 1.8 & 2.0 (330N)	07 on	Rear	←→	
62023	Gas Ryder		1/2	6,2	Volvo	C30	Hatch	04-11	Rear	←→	
					Volvo	S40	Mk II Incl. T5	04-11	Rear	←→	
62024	Gas Ryder		1/2	6,2	Audi	A4	Excl. Sport Susp. (B7)	05-08	Rear	←→	
62025	Gas Ryder		0	8,5	Renault	Logan	U 90	08 on	Rear	←→	
					Renault	Sandero	5-door Hatchback	09-14	Rear	←→	
62026	Gas Ryder		0	8,5	Nissan	Qashqai	1.6, 2.0, 1.5DCI (J10, JJ10)	07-14	Rear	←→	
62030	Gas Ryder				Mercedes-Benz	A Class	(W169) A150, A160, A170, A200, A160 CDi, A200 CDi	04-12	Rear	←→	
					Mercedes-Benz	B Class	(W245) B150, B160, B170, B200, B180 CDi, B200 CDi	05-11	Rear	←→	
62032	Gas Ryder		1/2	6,2	Mercedes-Benz	C Class	C180, C200, C220CDi, C230, C270CDi, C280, C320CDi, C350 (W203 & W204)	07 on	Rear	←→	
62033	Gas Ryder		0	8,5	Nissan	X-Trail	4x4 & 4x2 (Mk II)	08 on	Rear	←→	
62034	Gas Ryder		1/2	6,2	Audi	A6 - C6 (Type 4F)	All Excl. Air Susp.	04-11	Rear	←→	
62035	Gas Ryder		0	6,2	Renault	Scenic	Scenic I (Excl. 4x4)	98-04	Rear	←→	
62036	Gas Ryder		1/2	7,1	Hyundai	iX35	SUV 4x2	10 on	Rear	←→	
					Kia	Sportage	SUV 4x2	10 on	Rear	←→	
62037	Gas Ryder		0	8,5	Suzuki	Alto	Gen 7	09 on	Rear	←→	
62038	Gas Ryder		0	8,5	Daihatsu	Terios II	4x2, 4x4	6/06-on	Rear	←→	
62040	Gas Ryder		0	8,5	Daihatsu	Sirion	(Mk II) (Boon) Hatch	05-10	Rear	←→	
62043	Gas Ryder		1/2	6,2	Renault	Clio	Clio Mk III Hatch	06-13	Rear	←→	
62044	Gas Ryder		1/2	6,2	Opel	Corsa	(D) Hatch	07 on	Rear	←→	

PARTS LISTING

Shocks & Struts

62046



Part #	Range	Superceding Part #/Status	Product Type	Make	Model	Derivative	Year	Position	L/R	Note # (pg 6)
62046	Gas Ryder		⊗ 8.5	Peugeot	207	Hatch	06 on	Rear	↔	
62052	Gas Ryder		⊗ 6.2	Chevrolet	Cruze	Sedan	09 on	Rear	↔	
62053	Gas Ryder		⊗ 8.5	Hyundai	i10	Hatch	08 on	Rear	↔	
62055	Gas Ryder		⊗ 6.2	Suzuki	Swift	Hatch	08 on	Rear	↔	
62057	Gas Ryder		⊗ 6.2	Audi	A4	Sedan	08 on	Rear	↔	
62058	Gas Ryder		# 3.2	Honda	Jazz	Hatch	08 on	Rear	↔	
62060	Gas Ryder		⊗ 6.2	Toyota	Yaris/Vitz	Yaris/Vitz	99-05	Rear	↔	
62061	Gas Ryder		⊗ 6.2	Toyota	Ipsum	(ACM 2)	01 on	Rear	↔	
62073	Gas Ryder		⊗ 6.2	Ford	Focus	Mk III Hatch & Sedan (Excl. 2.5 ST & RS)	11 on	Rear	↔	
62082	Gas Ryder		⊗ 6.2	Volvo	S60	Sedan Excl. Elec. & Air Susp.	00-10	Rear	↔	
62083	Gas Ryder		⊗ 6.2	Mercedes-Benz	E Class	(W212) Sedan	09 on	Rear	↔	
62084	Gas Ryder		⊗ 8.5	Kia	Picanto	Hatch	11 on	Rear	↔	
62085	Gas Ryder		⊗ 7,1	Hyundai	Elantra	HD Sedan	06-10	Rear	↔	
62086	Gas Ryder		⊗ 8,5	Hyundai	i20	Hatch	09 on	Rear	↔	
				Kia	Cerato	Hatch & Sedan	09-13	Rear	↔	
62089	Gas Ryder		⊗ 8.5	Chevrolet	Spark	M200, M250 Hatch	06-10	Rear	↔	
62090	Gas Ryder		⊗ 6.2	Toyota	Yaris	Hatch	11 on	Rear	↔	
62091	Gas Ryder		⊗ 6.2	Nissan	Micra	Hatch	11 on	Rear	↔	
62092	Gas Ryder		⊗ 6.2	Mercedes-Benz	C Class	(CLC 203) Coupe	00-11	Rear	↔	
62093	Safari		⊗ 6.2	Hyundai	Accent	Sedan	11-13	Rear	↔	
62094	Gas Ryder		⊗ 6.2	Nissan	Livina	Incl. X-Gear & Grand Livina (XJ)	06 on	Rear	↔	
62102	Gas Ryder			Nissan	Juke	(F15) All	11 On	Rear	↔	
62351	Gas Ryder		# 3,2	BMW	7 Series	E23 Series (Excl. )	77-86	Rear	↔	18
62352	Gas Ryder		# 3,2	BMW	5 Series	E28 Series (Excl. M5)	85-89	Rear	↔	14
62353	Gas Ryder		# 3,2	BMW	5 Series	E34 Series (Excl.  , M5)	89-96	Rear	↔	14
69050	Gas Ryder		# 3,2	Volkswagen	Citi	Incl. Chicco (Excl. Sonic, Life & VeloCiti)	84 on	Rear	↔	9
				Volkswagen	Fox	Incl. Shuttle	87-95	Rear	↔	9
				Volkswagen	Golf	Mk I	78-79	Rear	↔	9
				Volkswagen	Golf	Mk I	79-84	Rear	↔	9
				Volkswagen	Jetta	Mk I	78-85	Rear	↔	9
				Volkswagen	Jetta	Mk I	79-85	Rear	↔	9
69067	Gas Ryder		# 3,2	Honda	Ballade	130, 150, 150i (SC9) (Civic)	84-87	Rear	↔	14
				Honda	Ballade	160i (SH4) (Civic)	87-89	Rear	↔	14

62046 – 69067



69068

PARTS LISTING

Shocks & Struts

69068 – 69093

Part #	Range	Superceding Part#/Status	Product Type	Make	Model	Derivative	Year	Position	L/R	Note # (pg 6)
69068	Gas Ryder		‡ 3,2	Volkswagen	Golf	Mk II	84-92	Rear	↔	9
				Volkswagen	Golf	Mk III (Excl. VR6 & Cabriolet), Mk II All (Excl. Cabriolet)	93-94	Rear	↔	9
				Volkswagen	Golf	Mk III All (Excl. Cabriolet)	95-99	Rear	↔	9
				Volkswagen	Golf	Mk III GTi	94-99	Rear	↔	9
				Volkswagen	Golf	Mk III VR6	93-99	Rear	↔	9
				Volkswagen	Jetta	Mk II	85-92	Rear	↔	9
				Volkswagen	Jetta	Mk III	95-99	Rear	↔	9
				Volkswagen	Jetta	Mk III Cli	94-99	Rear	↔	9
				Volkswagen	Jetta	Mk III (Excl. VR6), Mk II	93-94	Rear	↔	9
				Volkswagen	Jetta	Mk III VR6	93-99	Rear	↔	9
69069	Gas Ryder	G45469	⊖ 6,1	Toyota	Cressida	MX63 (Mk II)	81-93	Rear	↔	
69072	Gas Ryder		‡ 3,2	Audi	400, 500	C3, C4	83-94	Rear	↔	14
				Audi	A6	Incl. Avant. Excl. Quattro (C4)	94-97	Rear	↔	14
69073	Gas Ryder		‡ 3,2	Nissan	Skyline	R31	87-92	Rear	↔	13
				Nissan	Skyline	2800 GLX, GTX (R30)	82-87	Rear	↔	13
69074	Gas Ryder		‡ 3,2	Nissan	Laurel	C230	78-87	Rear	↔	13
				Nissan	Skyline	1800, 2000 (R30)	82-87	Rear	↔	13
69075	Gas Ryder		‡ 3,1	Honda	Ballade	150, 160i (SH4) (Civic)	89-92	Front	↔	
69076	Gas Ryder		‡ 3,2	Honda	Ballade	150, 160i (SH4) (Civic)	89-92	Rear	↔	
				Honda	Ballade	150, 160i (SR4) (Civic)	92-96	Rear	↔	
69079	Gas Ryder		‡ 3,1	Honda	Ballade	150, 160i (SR4) (Civic)	92-96	Front	↔	
69081	Gas Ryder		‡ 3,2	Volkswagen	Polo	Classic (Mk III)	96-02	Rear	↔	9
				Volkswagen	Polo	Playa (9N)	98-02	Rear	↔	9
69082	Gas Ryder		‡ 3,3	Ford	Fiesta	Mark IV (Excl. 1.6 Rsi 3-door) (U Bracket)	97-99	Rear	↔	23
				Ford	Ikon	B3 (U Bracket)	00-06	Rear	↔	23
69084	Gas Ryder		‡ 3,1	Honda	Ballade	150i, 160i, 180i Excl. Vtech (Mk VI) (Civic)	96-01	Front	↔	
				Honda	Civic	Mk VI	96-01	Front	↔	
69087	Gas Ryder		‡ 3,3	Audi	A4	1.8, 2.4, 2.6, 2.8 Excl. Quattro (B5)	94-01	Front	↔	
				Audi	A4	Quattro Excl. Sport Susp. (B5)	94-01	Front	↔	
				Volkswagen	Passat	1.6, 1.8, 1.8T, 2.0, 1.9TDI Excl. 4x4 (B5)	99-05	Front	↔	
				Volkswagen	Passat	B5 2.3 V5 & 2.8 4WD 4-Motion Syncro	99-05	Front	↔	
69089	Gas Ryder		‡ 3,2	Volkswagen	Citi	Sonic, Life & VeloCiti	98 on	Rear	↔	9
69092	Gas Ryder		‡ 3,2	Toyota	Bubble	(1NZ)	02-07	Rear	↔	
				Toyota	Corolla	E120, E130	02-07	Rear	↔	
				Toyota	RunX	E120, E130	02-07	Rear	↔	
69093	Gas Ryder		‡ 3,2	Nissan	Almera	Excl. ABS (N16)	01-07	Rear	↔	



Part #	Range	Superceding Part #/Status	Product Type	Make	Model	Derivative	Year	Position	L/R	Note # (pg 6)	
69095	Gas Ryder		f	3,2	Ford	Fiesta	Mark IV (Excl. 1.6 Rsi 3-door) (Sleeve eye)	99-03	Rear	↔	22
					Ford	Ilkon	B3 (Sleeve eye)	00-06	Rear	↔	22
					Mazda	Soho	121 (Eye)	97-99	Rear	↔	22
69099	Gas Ryder		f	3,1	Hyundai	Sonata	EF	03.01-02.05	Front	↔	
					Hyundai	Sonata	EF	09.98-03.01	Front	↔	
69100	Gas Ryder		f	3,2	Hyundai	Sonata	EF	03.01-02.05	Rear	↔	
69101	Gas Ryder		f	3,3	Audi	A4	Excl. Sport Susp. (B6)	01-05	Front	↔	
					Audi	A4	Excl. Sport Susp. (B7)	05-08	Front	↔	
69102	Gas Ryder		†	5	BMW	1 Series	E81 3-Door	07-11	Rear	↔	
					BMW	1 Series	E82 Coupe	08 on	Rear	↔	
					BMW	1 Series	E87 5-Door	04-11	Rear	↔	
					BMW	1 Series	E88 Cabriolet	08 on	Rear	↔	
					BMW	3 Series	E90 Series (Excl. M3, Cabrio & Coupe)	05-12	Rear	↔	
					BMW	3 Series	E91 Series	05-12	Rear	↔	
					BMW	3 Series	E92 Series	07 on	Rear	↔	
					BMW	3 Series	E93 Series	07 on	Rear	↔	
69103	Gas Ryder		⊖	6,2	Toyota	Corolla	NZE120/121, ZZE121	02 on	Rear	↔	
69104	Gas Ryder		⊖	6,2	Honda	CR-V	Mk II 4x4 2.0, 2.2D (RD4, RD5, RD6, RD7)	02 on	Rear	↔	
69106	Gas Ryder		⊖	6,2	Toyota	Verso	1.6, 1.8, 2.0 (Mk III) (Spacio)	04-09	Rear	↔	
69107	Gas Ryder		⊖	8,5	Mazda	Mazda 6	All Excl. MPS (GG/GY)	03 on	Front	↔	
69108	Gas Ryder		⊖	8,5	Mazda	Mazda 6	All Excl. MPS (GG/GY)	03 on	Front	↔	
69109	Gas Ryder		f	3,2	Mini	Cooper	(R50, R53) One, Cooper & Cooper S	02-06	Rear	↔	
69110	Gas Ryder		⊖	6,2	Volvo	S40	Excl. T4 & T4 Rear (Mk I)	00-04	Rear	↔	
69117	Gas Ryder		f	3,2	Jeep (Chrysler)	Jeep	Patriot (MK) SUV	07 on	Rear	↔	
					Dodge (Chrysler)	Caliber	Hatch	06-12	Rear	↔	
69119	Gas Ryder		f	1,1	Audi	A4	B8 (Excl. Sport Susp. Quattro & S4)	08 on	Front	↔	
69120	Gas Ryder		f	3,2	Honda	CR-V	SUV 4x4 (Mk III) RD6	07-12	Rear	↔	
69121	Gas Ryder		⊖	6,2	BMW	5 Series	E60 Series Sedan	04-10	Rear	↔	
69122	Gas Ryder		f	3,2	Toyota	Tercel	(Starlet) (EL4/NL4)	90-96	Rear	↔	
69123	Gas Ryder		⊖	0	Toyota	Chaser	(Mk II) (G100)	92-02	Rear	↔	
69401	Gas Ryder		⊖	8,5	Peugeot	206	1.4, 1.6	01-06	Rear	↔	
69412	Gas Ryder		⊖	8,5	Hyundai	Atoz	Mk I	97-98	Rear	↔	
69415	Gas Ryder		⊖	8,5	Opel	Zafira	A	01-06	Rear	↔	
69422	Gas Ryder		⊖	6,2	Ford	Focus	Mk I Hatch & Sedan	98-04	Rear	↔	
69423	Gas Ryder		⊖	13,2	Ford	Escort	Mk V	95-99	Rear	↔	



69425

PARTS LISTING

Shocks & Struts

69425 – 69946

Part #	Range	Superceding Part#/Status	Product Type	Make	Model	Derivative	Year	Position	L/R	Note # (pg 6)
69425	Gas Ryder		⊘ 6,2	Renault	Clio	Clio II 1.6 16V Sport	00-06	Rear	↔	
69431	Gas Ryder		⊘ 8,5	Daewoo	Matiz	Spark	99-03	Rear	↔	
69444	Gas Ryder		⊘ 8,5	Mercedes-Benz	A Class	(W168) A160, A190, 170CDI	00-04	Rear	↔	
69446	Gas Ryder		⊘ 8,5	Peugeot	206	1.4HDi, 2.0HDi	04-07	Rear	↔	
				Peugeot	206	1.6 Estate	03-07	Rear	↔	
				Peugeot	206	2.0 GTi	00-06	Rear	↔	
				Peugeot	206	CC 1.6, CC 2.0	01-07	Rear	↔	
69487	Gas Ryder	G45879	⊘ 6,2	Volkswagen	Polo	Mk IV	02-09	Rear	↔	
69506	Gas Ryder		⊘ 6,2	Volkswagen	Touran	Typ 1T	04-10	Rear	↔	
69507	Gas Ryder		⊘ 6,2	Audi	A3	3-Door (8P1)	04 on	Rear	↔	
				Audi	A3	Sportback 4x2, Sportback Quattro 4x4 (8PA)	05 on	Rear	↔	
69512	Gas Ryder		⊘ 11	Renault	Scenic	Scenic II	04-09	Rear	↔	
69538	Gas Ryder		⊘ 11	Renault	Megane	II Hatch (Excl. 2.0 T Sport)	04-08	Rear	↔	
				Renault	Megane	II Sedan (Excl. 2.0 T Sport)	04-08	Rear	↔	
69677	Gas Ryder		⊘ 6,2	Jaguar	Jaguar	XJ6, XJ12 (4 shocks at Rear)	70-87	Front	↔	
69744	Gas Ryder		⊘ 6,2	Mercedes-Benz	C Class	(W201) 190E (Excl. ⓈI)	83-94	Rear	↔	
				Mercedes-Benz	C Class	(W124) 200, 230E, 260E, 300D, 300E (Excl. ⓈI)	86-95	Rear	↔	
69807	Gas Ryder	69744	⊘ 6,2	Mercedes-Benz	C Class	(W201) 190E (Excl. ⓈI)	83-94	Rear	↔	
				Mercedes-Benz	E Class	(W124) 200, 230E, 260E, 300D, 300E (Excl. ⓈI)	86-95	Rear	↔	
69901	Gas Ryder		⊘ 6,2	Volvo	850	Excl. ⓈI, Ⓢ	94-97	Rear	↔	
				Volvo	850	Excl. ⓈI, Ⓢ	94-97	Rear	↔	
				Volvo	C70	Excl. T5 (Mk I)	97-00	Rear	↔	
				Volvo	S70, V70	Excl. ⓈI, Ⓢ	97-00	Rear	↔	
69919	Gas Ryder		⊘ 8,5	Alfa-Romeo	155	2.0 (Excl. Ⓢ)	96-98	Rear	↔	
				Alfa-Romeo	155	2.5 (Excl. Ⓢ)	96-98	Rear	↔	
				Fiat	Palio	Weekend (Type 2G)	02 on	Rear	↔	
				Fiat	Palio	Weekend (Type PY)	00-02	Rear	↔	
69921	Gas Ryder		⊘ 8,5	Fiat	Seicento	600	99-03	Rear	↔	
69924	Gas Ryder		⊘ 8,5	Volkswagen	Sharan	Mk I, Mk IA, Mk IB	95-10	Rear	↔	
69926	Gas Ryder		⊘ 6,2	Peugeot	406	Saloon	96-04	Rear	↔	
69927	Gas Ryder		⊘ 8,5	Renault	Megane	I (Excl. Coupe)	96-03	Rear	↔	
				Renault	Megane	I (Excl. Coupe)	96-03	Rear	↔	
69928	Gas Ryder	62035	⊘ 6,2	Renault	Scenic	Scenic I (Excl. 4x4)	98-04	Rear	↔	
69946	Gas Ryder		⊘ 6,2	Audi	A6	Excl. ⓈI & Quattro (C5)	97-04	Rear	↔	
				Volkswagen	Passat	1.6, 1.8, 1.8T, 2.0, 1.9TDI Excl. 4x4 (B5)	96-99	Rear	↔	
				Volkswagen	Passat	2.3VR5 Excl. 4x4 (B5)	99-05	Rear	↔	
				Volkswagen	Passat	2.8 V6 (B5)	99-05	Rear	↔	

PARTS LISTING

Shocks & Struts

69948



Part #	Range	Superceding Part #/Status	Product Type	Make	Model	Derivative	Year	Position	L/R	Note # (pg 6)
69948	Gas Ryder		1/0 6,2	BMW	Z3	E36/4	98-03	Rear	↔	
69952	Gas Ryder		1/0 6,2	Mercedes-Benz	E Class	(W210) E200, E220D, E280, E280TD, E290TD (Excl. 1.5, 1.8)	95-02	Front	↔	
				Mercedes-Benz	E Class	(W210) E230, E250D	95-99	Front	↔	
69965	Gas Ryder		0/0 8,5	Citroen	XSARA	Mark 2 (Excl. VTS)	00-06	Rear	↔	
				Peugeot	306	Hatchback, saloon & Cabriolet (Excl. Estate)	93-02	Rear	↔	
69966	Gas Ryder		1/0 6,2	Mercedes-Benz	E Class	(W210) E200, E220D, E280, E280TD, E290TD (Excl. 1.5, 1.8)	95-02	Rear	↔	
69986	Gas Ryder	G45881	0/0 8,5	Opel	Astra	Excl. 2.0 OPC (G)	99-03	Rear	↔	
				Opel	Astra	Excl. 2.0 OPC (G)	99-03	Rear	↔	
69987	Gas Ryder		0/0 8,5	Opel	Astra	Caravan, Excl. 2.0 OPC (G)	98-04	Rear	↔	
69989	Gas Ryder		1/0 6,2	Renault	Clio	Clio II 1.4, 1.5dCi & 1.6 (Excl. 1.2, 1.6 Sport, 2.0 & 3.0)	00-06	Rear	↔	
70500	Gas Ryder		1/1	Nissan	Almera	Excl. ABS (N16)	01-07	Front	L	
70501	Gas Ryder		1/1	Nissan	Almera	Excl. ABS (N16)	01-07	Front	R	
70503	Gas Ryder		1/1	Volkswagen	Polo	Mk IV	02-09	Front	↔	
70504	Gas Ryder		1/1	Opel	Corsa	Excl. Corsa Lite (C)	02-07	Front	↔	
70505	Gas Ryder		1/1	Opel	Astra	Caravan, Excl. 2.0 OPC (G)	98-04	Front	↔	
				Opel	Astra	Excl. 2.0 OPC (G)	99-03	Front	↔	
				Opel	Astra	Excl. 2.0 OPC (G)	99-03	Front	↔	
70506	Gas Ryder		1/1	Mercedes-Benz	Sprinter	P-Van (Excl. 312, 515, 518 & 519)	06 on	Front	↔	
				Volkswagen	Crafter	3 Ton, 3, 5 Ton (Excl. 4x4 & 5 Ton) (LT3)	06 on	Front	↔	
70508	Gas Ryder		1/1	BMW	3 Series	E46 Series (Excl. M3, 1.8 + Touring) one pin at the bottom Strut mounting	99-05	Front	L	24
70509	Gas Ryder		1/1	BMW	3 Series	E46 Series (Excl. M3, 1.8 + Touring) one pin at the bottom Strut mounting	99-05	Front	R	24
70510	Gas Ryder		1/1	Ford	Bantam	1.3, 1.6	03-06	Front	↔	
				Ford	Bantam	1.3, 1.6 (Mk III)	06 on	Front	↔	
				Ford	Bantam	1.3, 1.6, 1.8D	02	Front	↔	
70511	Gas Ryder		1/1	Renault	Megane	I (Excl. Coupe)	96-03	Front	↔	
				Renault	Scenic	Scenic I (Excl. 4x4)	98-04	Front	↔	
70512	Gas Ryder		1/1	Renault	Clio	Clio II 1.4, 1.5dCi & 1.6 (Excl. 1.2, 1.6 Sport, 2.0 & 3.0)	00-06	Front	↔	
70519	Gas Ryder		1/1	Hyundai	Elantra	J2 & J3 Series (Avante)	96-00	Front	L	
				Hyundai	Elantra	XD (J4) (Avante)	01-07	Front	L	
				Hyundai	Tiburon	RC	96-00	Front	L	
70520	Gas Ryder		1/1	Hyundai	Elantra	J2 & J3 Series (Avante)	96-00	Front	R	
				Hyundai	Elantra	XD (J4) (Avante)	01-07	Front	R	
				Hyundai	Tiburon	RC	96-00	Front	R	
70521	Gas Ryder		1/1	Hyundai	Elantra	XD (J4) (Avante)	01-07	Rear	L	
70522	Gas Ryder		1/1	Hyundai	Elantra	XD (J4) (Avante)	01-07	Rear	R	

69948 - 70522



70523

PARTS LISTING

Shocks & Struts

70523 - 70559

Part #	Range	Superceding Part#/Status	Product Type	Make	Model	Derivative	Year	Position	L/R	Note # (pg 6)
70523	Gas Ryder		1,1	Toyota	Rav 4	Sealed struts (XA10)	98-00	Front	L	
70524	Gas Ryder		1,1	Toyota	Rav 4	Sealed struts (XA10)	98-00	Front	R	
70527	Gas Ryder		1,1	Opel	Corsa	Utility	04 on	Front	←→	
70528	Gas Ryder	35941	1,1	Chevrolet	Aveo	T200 (Kalos)	02 on	Front	L	
70529	Gas Ryder	35942	1,1	Chevrolet	Aveo	T200 (Kalos)	02 on	Front	R	
70530	Gas Ryder		1,1	Hyundai	Matrix	(Lavita) Mini MPV	02 on	Rear	L	
70531	Gas Ryder		1,1	Hyundai	Matrix	(Lavita) Mini MPV	02 on	Rear	R	
70538	Gas Ryder		1,1	Mercedes-Benz	Vito	112 CDI Bus	03-04	Front	←→	
				Mercedes-Benz	Vito	112 CDI 2.2 Cr-Cab P-Van Dsl	03	Front	←→	
				Mercedes-Benz	Vito	112 CDI 2.2 P-Van Dsl	02-04	Front	←→	
70539	Gas Ryder		1,1	Peugeot	206	1.4, 1.6	01-06	Front	L	
70540	Gas Ryder		1,1	Peugeot	206	1.4, 1.6	01-06	Front	R	
70542	Gas Ryder		1,1	BMW	X5	E53 3.0i, 3.0d, 4.4iV8, 4.8 V8 4x4	01-07	Front	L	
70543	Gas Ryder		1,1	BMW	X5	E53 3.0i, 3.0d, 4.4iV8, 4.8 V8 4x4	01-07	Front	R	
70544	Gas Ryder		1,1	Hyundai	Elantra	J2 & J3 Series (Avante)	96-00	Rear	L	
70545	Gas Ryder		1,1	Hyundai	Elantra	J2 & J3 Series (Avante)	96-00	Rear	R	
70546	Gas Ryder		1,1	Volkswagen	Jetta	6 Sedan (50mm OD)	11 on	Front	←→	
				Audi	A3	50mm Strut Body. All (8P1) - Excl. Quattro, Sport Susp. & S3.	03-12	Front	←→	
				Audi	A3	50mm Strut Body. Sportback (8PA) Excl. Quattro, Sport Susp. & S3.	05-12	Front	←→	
				Volkswagen	Civic	All 50mm OD Strut	04 on	Front	←→	
				Volkswagen	Golf	Mk V 50mm Strut Body (Excl. GTi)	04-09	Front	←→	
				Volkswagen	Golf	Mk V 50mm Strut Body (Excl. GTi)	09 on	Front	←→	
				Volkswagen	Jetta	Mk V 50mm OE Strut Body (Excl. V5 & Sport Susp.)	06-11	Front	←→	
70547	Gas Ryder	70609	1,1	Toyota	Yaris	T1 1.0L, T3 1.3L (Mk II) Hatch & T3 1.3L (Mk II) Sedan	05-11	Front	L	
				Toyota	Yaris	T1 1.0L, T3 1.3L (Mk II) Hatch & T3 1.3L (Mk II) Sedan	05-11	Front	R	
70548	Gas Ryder		1,1	Hyundai	Getz	3 & 5-door	03 on	Front	L	
70549	Gas Ryder		1,1	Hyundai	Getz	3 & 5-door	03 on	Front	R	
70550	Gas Ryder		1,1	Hyundai	Matrix	(Lavita) Mini MPV	02 on	Front	L	
70551	Gas Ryder		1,1	Hyundai	Matrix	(Lavita) Mini MPV	02 on	Front	R	
70554	Gas Ryder		1,1	Hyundai	Santa FE	SM	01-06	Front	L	
70555	Gas Ryder		1,1	Hyundai	Santa FE	SM	01-06	Front	R	
70556	Gas Ryder		1,1	Nissan	X-Trail	4x4 & 4x2 (Mk I)	01-07	Front	L	
70557	Gas Ryder		1,1	Nissan	X-Trail	4x4 & 4x2 (Mk I)	01-07	Front	R	
70558	Gas Ryder		1,1	Nissan	X-Trail	4x4 & 4x2 (Mk I)	01-07	Rear	L	
70559	Gas Ryder		1,1	Nissan	X-Trail	4x4 & 4x2 (Mk I)	01-07	Rear	R	



Part #	Range	Superceding Part #/Status	Product Type	Make	Model	Derivative	Year	Position	L/R	Note # (pg 6)	
70560	Gas Ryder		1	1,1	Volkswagen	Civic	All 55mm OD Strut	04 on	Front	↔	
					Volkswagen	Golf	Mk V 55mm Strut Body (Excl. GTi)	04-09	Front	↔	
					Volkswagen	Golf	Mk V 55mm Strut Body (Excl. GTi)	09 on	Front	↔	
					Volkswagen	Jetta	Mk V 55mm OE Strut Body (Excl. V5 & Sport Susp.)	06-11	Front	↔	
					Volkswagen	Passat	B6 All (Excl. Sport Susp. & 4WD 4-Motion Syncro)	05-11	Front	↔	
70561	Gas Ryder		1	1,1	Toyota	Auris	1.4 & 1.6 (330N)	07-12	Front	L	
					Toyota	Corolla	1.3, 1.4, 1.6, 1.8, & 2.0 D4D (E140, E150)	07 on	Front	L	
70562	Gas Ryder		1	1,1	Toyota	Auris	1.4 & 1.6 (330N)	07-12	Front	R	
					Toyota	Corolla	1.3, 1.4, 1.6, 1.8, & 2.0 D4D (E140, E150)	07 on	Front	R	
70563	Gas Ryder		1	1,1	Chevrolet	Optra (Lacetti)	1.6 & 1.8 (Mk I)	02-08	Front	L	
70564	Gas Ryder		1	1,1	Chevrolet	Optra (Lacetti)	1.6 & 1.8 (Mk I)	02-08	Front	R	
70565	Gas Ryder		1	1,1	Chevrolet	Optra (Lacetti)	1.6 & 1.8 (Mk I)	02-08	Rear	R	
70566	Gas Ryder		1	1,1	Chevrolet	Optra (Lacetti)	1.6 & 1.8 (Mk I)	02-08	Rear	L	
70567	Gas Ryder		1	1,1	Ford	Fiesta	Mark V Hatch & Sedan	02-08	Front	L	
					Ford	Figo	1.4	10 on	Front	L	
					Ford	Ikon	Sedan All	07 on	Front	L	
					Mazda	Demio	Hatch DY	02-07	Front	L	
70568	Gas Ryder		1	1,1	Ford	Fiesta	Mark V Hatch & Sedan	02-08	Front	R	
					Ford	Figo	1.4	10 on	Front	R	
					Ford	Ikon	Sedan All	07 on	Front	R	
					Mazda	Demio	Hatch DY	02-on	Front	R	
					Mazda	Mazda 2	Hatch DY (Demio)	02-07	Front	R	
70569	Gas Ryder		1	1,1	Hyundai	i10	Hatch	08 on	Front	L	
					Kia	Picanto	Mk 1 Incl. 2007 & 2010 facelift (SA)	04-11	Front	L	
70570	Gas Ryder		1	1,1	Hyundai	i10	Hatch	08 on	Front	R	
					Kia	Picanto	Mk 1 Incl. 2007 & 2010 facelift (SA)	04-11	Front	R	
70571	Gas Ryder		1	1,1	Toyota	Corona/Caldina	ST210, CT210 2.0 & 2.0 Diesel Sedan	01.96-12.01	Front	L	
					Toyota	Corona/Caldina	ST215G/W (2.0 & 2.0 Turbo 4WD GT & GTT)	12.99-09.02	Front	L	
					Toyota	Corona/Carina e	AT190, ST191, CT190 Sedan made in the UK	01.96-10.97	Front	L	
					Toyota	Corona/Carina e	ST191 2.0 Station Wagon	11.92-01.96	Front	L	
					Toyota	Corona/Carina e	ST191, CT190 2.0 & 2.0 Diesel Sedan & LB: 5-door Hatchback	03.92-05.98	Front	L	
					Toyota	Corona/Carina e	ST191, CT190 2.0 & 2.0 Diesel Sedan & LB: 5-door Hatchback with Harsh Road Package	02.96-05.98	Front	L	

70560 - 70571





70572

PARTS LISTING

Shocks & Struts

70572 - 70586

Part #	Range	Superceding Part#/Status	Product Type	Make	Model	Derivative	Year	Position	L/R	Note # (pg 6)
70572	Gas Ryder		1,1	Toyota	Corona/Caldina	ST210, CT210 2.0 & 2.0 Diesel Sedan	01.96-12.01	Front	R	
				Toyota	Corona/Caldina	ST215G/W (2.0 & 2.0 Turbo 4WD GT & GTT)	12.99-09.02	Front	R	
				Toyota	Corona/Carina e	AT190, ST191, CT190 Sedan made in the UK	01.96-10.97	Front	R	
				Toyota	Corona/Carina e	ST191 2.0 Station Wagon	11.92-01.96	Front	R	
				Toyota	Corona/Carina e	ST191, CT190 2.0 & 2.0 Diesel Sedan & LB: 5-door Hatchback	03.92-05.98	Front	R	
				Toyota	Corona/Carina e	ST191, CT190 2.0 & 2.0 Diesel Sedan & LB: 5-door Hatchback with Harsh Road Package	02.96-05.98	Front	R	
70573	Gas Ryder		1,1	Toyota	Corona/Caldina	ST210, CT210 2.0 & 2.0 Diesel Sedan	01.96-12.01	Rear	L	
				Toyota	Corona/Carina e	ST191 2.0 Sedan & LB: 5-door Hatchback	03.92-02.96	Rear	L	
				Toyota	Corona/Carina e	ST191, CT190 2.0 & 2.0 Diesel Sedan & LB: 5-door Hatchback	03.92-05.98	Rear	L	
70574	Gas Ryder		1,1	Toyota	Corona/Caldina	ST210, CT210 2.0 & 2.0 Diesel Sedan	01.96-12.01	Rear	R	
				Toyota	Corona/Carina e	ST191 2.0 Sedan & LB: 5-door Hatchback	03.92-02.96	Rear	R	
				Toyota	Corona/Carina e	ST191, CT190 2.0 & 2.0 Diesel Sedan & LB: 5-door Hatchback	03.92-05.98	Rear	R	
70575	Gas Ryder		1,1	Nissan	Micra	5-Door (K12)	04 on	Front	L	
70576	Gas Ryder		1,1	Nissan	Micra	5-Door (K12)	04 on	Front	R	
70577	Gas Ryder		1,1	BMW	1 Series	E81 3-Door (Excl. Sport Susp. &135i)	07-11	Front	L	
				BMW	1 Series	E82 Coupe (Excl. Sport Susp. &135i)	08 on	Front	L	
				BMW	1 Series	E87 5-Door (Excl. Sport Susp. &135i)	04-11	Front	L	
				BMW	1 Series	E88 Cabriolet (Excl. Sport Susp. &135i)	08 on	Front	L	
				BMW	3 Series	E90 Series (Excl. M3, )	05-12	Front	L	
70578	Gas Ryder		1,1	BMW	1 Series	E81 3-Door (Excl. Sport Susp. &135i)	07-11	Front	R	
				BMW	1 Series	E82 Coupe (Excl. Sport Susp. &135i)	08 on	Front	R	
				BMW	1 Series	E87 5-Door (Excl. Sport Susp. &135i)	04-11	Front	R	
				BMW	1 Series	E88 Cabriolet (Excl. Sport Susp. &135i)	08 on	Front	R	
				BMW	3 Series	E90 Series (Excl. M3, )	05-12	Front	R	
70579	Gas Ryder		1,1	Toyota	Avanza	1.3 & 1.5 (Xenia) Excl. ABS	06 on	Front	L	
70580	Gas Ryder		1,1	Toyota	Avanza	1.3 & 1.5 (Xenia) Excl. ABS	06 on	Front	R	
70581	Gas Ryder		1,1	Volkswagen	Golf	Mk V 2.0 GTi	04-09	Front	← →	
70583	Gas Ryder		1,1	Fiat	Palio	Expresso P-Van	02 on	Front	← →	
				Fiat	Palio	Type 2H	02 on	Front	← →	
70584	Gas Ryder		1,1	Ford	Focus	Mk II Hatch & Sedan (Excl. 2.5 RS & ST)	04-11	Front	L	
70585	Gas Ryder		1,1	Ford	Focus	Mk II Hatch & Sedan (Excl. 2.5 RS & ST)	04-11	Front	R	
70586	Gas Ryder		1,1	Nissan	NP200	1.5, 1.6	08 on	Front	← →	

PARTS LISTING

Shocks & Struts

70587



70587 - 70624

Part #	Range	Superceding Part #/Status	Product Type	Make	Model	Derivative	Year	Position	L/R	Note # (pg 6)
70587	Gas Ryder		1,1	BMW	3 Series	E36 Series (Imported Excl. M-Series) 320i, 325i, 325td (long Stud)	91-92	Front	L	
70588	Gas Ryder		1,1	BMW	3 Series	E36 Series (Imported Excl. M-Series) 320i, 325i, 325td (long Stud)	91-92	Front	R	
70589	Gas Ryder		1,1	Nissan	Livina	Incl. X-Gear & Grand Livina (XJ)	06-14	Front	L	
				Nissan	Tiida	1.6i & 1.8i Hatch & Sedan	06 on	Front	L	
70590	Gas Ryder		1,1	Nissan	Livina	Incl. X-Gear & Grand Livina (XJ)	06-14	Front	R	
				Nissan	Tiida	1.6i & 1.8i Hatch & Sedan	06 on	Front	R	
70591	Gas Ryder		1,1	Volkswagen	Kombi	T5 Transporter: Caravelle, Crew bus, Pickup & P-Van (Excl. 4-Motion)	04 on	Front	←→	
70592	Gas Ryder		1,1	Mazda	Mazda 3	1.6, 2.0 Excl. 2.3 MPS (Mk I)	04-09	Front	L	
70593	Gas Ryder		1,1	Mazda	Mazda 3	1.6, 2.0 Excl. 2.3 MPS (Mk I)	04-09	Front	R	
70594	Gas Ryder		1,1	Fiat	Strada	3/4 Ton LDV (Mk II)	05 on	Front	←→	
70596	Gas Ryder		1,1	Chevrolet	Spark	M300 (Excl. Lite)	10 on	Front	L	
70597	Gas Ryder		1,1	Chevrolet	Spark	M300 (Excl. Lite)	10 on	Front	R	
70598	Gas Ryder		1,1	Honda	Civic	Mk VIII	06-11	Front	L	
70599	Gas Ryder		1,1	Honda	Civic	Mk VIII	06-11	Front	R	
70600	Gas Ryder		1,1	Ford	Fiesta	Mk VI	08 on	Front	L	
				Mazda	Mazda 2	Hatch DE (Demio)	07 on	Front	L	
70601	Gas Ryder		1,1	Ford	Fiesta	Mk VI	08 on	Front	R	
				Mazda	Mazda 2	Hatch DE (Demio)	07 on	Front	R	
70602	Gas Ryder		2,1	Mercedes-Benz	C Class	(W203) C180, C200, C220CDi, C230, C270CDi, C280, C320CDi, C350	00-07	Front	←→	
70608	Gas Ryder		1,1	Toyota	Yaris	T1 1.0L, T3 1.3L (Mk II) Hatch	05-11	Front	L	
				Toyota	Yaris	T3 1.3L (Mk II) Sedan	06-11	Front	L	
70609	Gas Ryder		1,1	Toyota	Yaris	T1 1.0L, T3 1.3L (Mk II) Hatch	05-11	Front	R	
				Toyota	Yaris	T3 1.3L (Mk II) Sedan	06-11	Front	R	
70610	Gas Ryder		1,1	Honda	Jazz	1.4Dsi, 1.5 Gen 1	03-07	Front	L	
70611	Gas Ryder		1,1	Honda	Jazz	1.4Dsi, 1.5 Gen 1	03-07	Front	R	
70612	Gas Ryder		1,1	Honda	CR-V	Mk II 4x4 2.0, 2.2D	00-04	Front	L	
70613	Gas Ryder		1,1	Honda	CR-V	Mk II 4x4 2.0, 2.2D	00-04	Front	R	
70614	Gas Ryder		1,1	Land Rover	Freelander	Mk I (1.8, 2.0Td4, 2.5 V6)	98-3/07	Front	L	
70615	Gas Ryder		1,1	Land Rover	Freelander	Mk I (1.8, 2.0Td4, 2.5 V6)	98-3/07	Front	R	
70616	Gas Ryder		1,1	Land Rover	Freelander	Mk I (1.8, 2.0Td4, 2.5V6)	98-3/07	Rear	L	
70617	Gas Ryder		1,1	Land Rover	Freelander	Mk I (1.8, 2.0Td4, 2.5V6)	98-3/07	Rear	R	
70618	Gas Ryder		1,1	Toyota	Verso	1.6, 1.8, 2.0 (Mk III) (Spacio)	04-09	Front	L	
70619	Gas Ryder		1,1	Toyota	Verso	1.6, 1.8, 2.0 (Mk III) (Spacio)	04-09	Front	R	
70620	Gas Ryder		1,1	Kia	Rio	1.3 & 1.6 (DC)	03-06	Front	L	
70621	Gas Ryder		1,1	Kia	Rio	1.3 & 1.6 (DC)	03-06	Front	R	
70624	Gas Ryder		1,1	Hyundai	Accent	LC. 1.6	00-05	Front	L	



Part #	Range	Superceding Part#/Status	Product Type	Make	Model	Derivative	Year	Position	L/R	Note # (pg 6)
70625	Gas Ryder		1,1	Hyundai	Accent	LC. 1.6	00-05	Front	R	
70628	Gas Ryder		1,1	Toyota	Rav4	XA20 (Mk II)	01-06	Front	L	
				Chery	Tiggo	All	08-on	Front	L	
70629	Gas Ryder		1,1	Toyota	Rav4	XA20 (Mk II)	01-06	Front	R	
				Chery	Tiggo	All	08-on	Front	R	
70631	Gas Ryder		1,1	Opel	Astra	(H) 1.8 & 1.9 CDTi Incl. GTC (Excl. 2.0 Turbo Sport & OPC)	04-09	Front	L	
70632	Gas Ryder		1,1	Opel	Astra	(H) 1.8 & 1.9 CDTi Incl. GTC (Excl. 2.0 Turbo Sport & OPC)	04-09	Front	R	
70633	Gas Ryder		1,1	Volvo	C30	Hatch	07 on	Front	L	
				Volvo	S40	Mk II Incl. T5	04-11	Front	L	
70634	Gas Ryder		1,1	Volvo	C30	Hatch	07 on	Front	R	
				Volvo	S40	Mk II Incl. T5	04-11	Front	R	
70635	Gas Ryder		2,1	Hyundai	Tucson	All	04-11	Rear	L	
				Kia	Sportage	2.0, 2.7, 2.0D (Mk II)	04-10	Rear	L	
70636	Gas Ryder		4,1	Hyundai	Tucson	All	04-11	Rear	R	
				Kia	Sportage	2.0, 2.7, 2.0D (Mk II)	04-10	Rear	R	
70637	Gas Ryder		6,1	Hyundai	Tucson	All	04-11	Front	L	
				Kia	Sportage	2.0, 2.7, 2.0D (Mk II)	04-10	Front	L	
70638	Gas Ryder		8,1	Hyundai	Tucson	All	04-11	Front	R	
				Kia	Sportage	2.0, 2.7, 2.0D (Mk II)	04-10	Front	R	
70639	Gas Ryder		1,1	Renault	Logan	U 90	08 on	Front	←→	
				Renault	Sandero	5-door Hatchback	09-14	Front	←→	
70640	Gas Ryder		1,1	Audi	A3	55mm Strut Body. All (8P1) - Excl. Quattro, Sport Susp. & S3.	03-12	Front	←→	
				Audi	A3	55mm Strut Body. Sportback (8PA) Excl. Quattro, Sport Susp. & S3.	05-12	Front	←→	
70642	Gas Ryder		1.1	BMW	X3	E83 2.5i, 3.0i, 2.0d and 3.0d	04 on	Front	L	
70643	Gas Ryder		1.1	BMW	X3	E83 2.5i, 3.0i, 2.0d and 3.0d	04 on	Front	R	
70648	Gas Ryder		1.1	Honda	Civic	Mk VII	01-05	Front	L	
				Honda	Civic	Mk VII Sedan	01-05	Front	L	
70649	Gas Ryder		1.1	Honda	Civic	Mk VII	01-05	Front	R	
				Honda	Civic	Mk VII Sedan	01-05	Front	R	
70654	Gas Ryder		1.1	Mazda	626	1.8, 2.0 (Mk V), Y5 Sedan	99-03	Front	L	
70655	Gas Ryder		1.1	Mazda	626	1.8, 2.0 (Mk V), Y5 Sedan	99-03	Front	R	
70656	Gas Ryder		1.1	Mazda	626	1.8, 2.0 (Mk V), Y5 Sedan	99-03	Rear	L	
70657	Gas Ryder		1.1	Mazda	626	1.8, 2.0 (Mk V), Y5 Sedan	99-03	Rear	R	
70661	Gas Ryder		1.1	Nissan	Qashqai	1.6, 2.0, 1.5DCI (J10, JJ10)	07-14	Front	L	
70662	Gas Ryder		1.1	Nissan	Qashqai	1.6, 2.0, 1.5DCI (J10, JJ10)	07-14	Front	R	
70663	Gas Ryder		8,5	Nissan	X-Trail	4x4 & 4x2 (Mk II)	08 on	Front	L	



Part #	Range	Superceding Part #/Status	Product Type	Make	Model	Derivative	Year	Position	L/R	Note # (pg 6)	
70664	Gas Ryder		1	8,5	Nissan	X-Trail	4x4 & 4x2 (Mk II)	08 on	Front	R	
70673	Gas Ryder		1	1.1	Toyota	Rav4	All XA30	06-12	Front	L	
70674	Gas Ryder		1	1.1	Toyota	Rav4	All XA30	06-12	Front	R	
70679	Gas Ryder		1	1.1	Mini	Cooper	(R50, R53) One, Cooper & Cooper S	02-06	Front	L	
70680	Gas Ryder		1	1.1	Mini	Cooper	(R50, R53) One, Cooper & Cooper S	02-06	Front	R	
70682	Gas Ryder		1	1.1	Renault	Clio	Clio III Hatch	06-13	Front	↔	
70683	Gas Ryder		1	1.1	Volvo	S40	Excl. 2.0I, 2.0 & T4 Rear (Mk I)	00-04	Front	L	
70684	Gas Ryder		1	1.1	Volvo	S40	Excl. 2.0I, 2.0 & T4 Rear (Mk I)	00-04	Front	R	
70687	Gas Ryder		1	1.1	Suzuki	SX4	SX4	08 on	Front	L	
70688	Gas Ryder		1	S	Suzuki	SX4	SX4	08 on	Front	R	
					Land Rover	Freelander	Mk II (L359)	4/07-on	Rear	R	
70689	Gas Ryder		1	1.1	Suzuki	Swift	Hatch	08-10	Front	L	
70690	Gas Ryder		1	1.1	Suzuki	Swift	Hatch	08-10	Front	R	
70691	Gas Ryder		1	1.1	Hyundai	iX35	4x4, 4x2 (Excl. AWD)	10 on	Front	L	
					Kia	Sportage	SUV 4x2	10 on	Front	L	
70692	Gas Ryder		1	1.1	Hyundai	iX35	4x4, 4x2 (Excl. AWD)	10 on	Front	R	
					Kia	Sportage	SUV 4x2	10 on	Front	R	
70693	Gas Ryder		1	1.1	Suzuki	Alto	1.0 - Gen 7	09 on	Front	L	
70694	Gas Ryder		1	1.1	Suzuki	Alto	1.0 - Gen 7	09 on	Front	R	
70695	Gas Ryder		1	1.1	Daihatsu	Terios II	4x2, 4x4	6/06-on	Front	↔	
70696	Gas Ryder		1	1.1	Hyundai	i20	Hatch	09 on	Front	L	
70697	Gas Ryder		1	1.1	Hyundai	i20	Hatch	09 on	Front	R	
70700	Gas Ryder		1	1.1	Daihatsu	Sirion	(Mk II) (Boon) Hatch	05-10	Front	↔	
70701	Gas Ryder		1	1.1	Toyota	Avensis	Gen 2 (T250)	06-10	Front	L	
70702	Gas Ryder		1	1.1	Toyota	Avensis	Gen 2 (T250)	06-10	Front	R	
70703	Gas Ryder		1	1.1	Volkswagen	Touran	MPV	04 on	Front	↔	
70706	Gas Ryder		1	1.1	Chevrolet	Cruze J300 (Gen two)	Sedan & Hatch	09 on	Front	L	
70707	Gas Ryder		1	1.1	Chevrolet	Cruze J300 (Gen two)	Sedan & Hatch	09 on	Front	R	
70708	Gas Ryder		1	1.1	Opel	Corsa	(D) Hatch	07 on	Front	L	
70709	Gas Ryder		1	1.1	Opel	Corsa	(D) Hatch	07 on	Front	R	
70710	Gas Ryder		1	1.1	Fiat	Punto	Mk II	04-12	Front	↔	
70711	Gas Ryder		1	1.1	Jeep (Chrysler)	Jeep	Patriot (MK) SUV	07 on	Front	L	
					Dodge (Chrysler)	Caliber	Hatch	06-12	Front	L	
70712	Gas Ryder		1	1.1	Jeep (Chrysler)	Jeep	Patriot (MK) SUV	06-12	Front	R	
					Dodge (Chrysler)	Caliber	Hatch	06-12	Front	R	

70664 - 70712



70714

PARTS LISTING

Shocks & Struts

70714 - 70749

Part #	Range	Superceding Part#/Status	Product Type	Make	Model	Derivative	Year	Position	L/R	Note # (pg 6)
70714	Gas Ryder		1.1	Volkswagen	Polo	Hatch	10 on	Front	← →	
				Volkswagen	Polo	Vivo Hatch	10 on	Front	← →	
				Volkswagen	Polo	Sedan	11 on	Front	← →	
				Volkswagen	Polo	Vivo Sedan	10 on	Front	← →	
70715	Gas Ryder		1.1	Honda	Jazz	Hatch	08 on	Front	L	
70716	Gas Ryder		1.1	Honda	Jazz	Hatch	08 on	Front	R	
70718	Gas Ryder		1.1	Honda	CR-V	SUV 4x4 (Mk III) RD6	07-12	Front	L	
70719	Gas Ryder		1.1	Honda	CR-V	SUV 4x4 (Mk III) RD6	07-12	Front	R	
70722	Gas Ryder		1.1	BMW	5 Series	E60 Series Sedan	04-10	Front	← →	
70723	Gas Ryder		1.1	Toyota	Aygo	(KGB10R) All	11-15	Front	L	
70724	Gas Ryder		1.1	Toyota	Aygo	(KGB10R) All	11-15	Front	R	
70725	Gas Ryder		1.1	Toyota	Ipsum	(SM10)	96-01	Front	L	
70726	Gas Ryder		1.1	Toyota	Ipsum	(SM10)	96-01	Front	R	
70727	Gas Ryder		1.1	Toyota	Camry	(Gen 5) (SV20)	96-01	Front	L	
70728	Gas Ryder		1.1	Toyota	Camry	(Gen 5) (SV20)	96-01	Front	R	
70729	Gas Ryder		1.1	Toyota	Harrier	SXU 10, SXU 15 (Gen 1)	97-03	Front	L	
70730	Gas Ryder		1.1	Toyota	Harrier	SXU 10, SXU 15 (Gen 1)	97-03	Front	R	
70731	Gas Ryder		1.1	Toyota	Spaceo	(AE114)	97-01	Front	L	
70732	Gas Ryder		1.1	Toyota	Spaceo	(AE114)	97-01	Front	R	
70733	Gas Ryder		1.1	Toyota	Spaceo	(AE114)	97-01	Rear	L	
70734	Gas Ryder		1.1	Toyota	Spaceo	(AE114)	97-01	Rear	R	
70735	Gas Ryder		1.1	Toyota	Harrier	XU 10 (Gen 1)	97-03	Rear	L	
70736	Gas Ryder		1.1	Toyota	Harrier	XU 10 (Gen 1)	97-03	Rear	R	
70737	Gas Ryder		1.1	Toyota	Harrier	SXU 15 (Gen 1)	97-03	Rear	L	
70738	Gas Ryder		1.1	Toyota	Harrier	SXU 15 (Gen 1)	97-03	Rear	R	
70739	Gas Ryder		1.1	Toyota	Tercel	(Starlet) (EL4/NL4)	90-96	Front	L	
70740	Gas Ryder		1.1	Toyota	Tercel	(Starlet) (EL4/NL4)	90-96	Front	R	
70741	Gas Ryder		1.1	Mazda	Familia	(BJ)	00-04	Front	L	
70742	Gas Ryder		1.1	Mazda	Familia	(BJ)	00-04	Front	R	
70743	Gas Ryder		1.1	Mazda	Familia	(BJ)	00-04	Rear	L	
70744	Gas Ryder		1.1	Mazda	Familia	(BJ)	00-04	Rear	R	
70745	Gas Ryder		1.1	Mazda	Familia	(BJE)	99-00	Front	L	
70746	Gas Ryder		1.1	Mazda	Familia	(BJE)	99-00	Front	R	
70747	Gas Ryder		1.1	Mazda	Familia	(BJE)	99-00	Rear	L	
70748	Gas Ryder		1.1	Mazda	Familia	(BJE)	99-00	Rear	R	
70749	Gas Ryder		1.1	Honda	Fit	(Gen 1) (GD1)	07 on	Front	L	

PARTS LISTING

Shocks & Struts

70750



Part #	Range	Superceding Part #/Status	Product Type	Make	Model	Derivative	Year	Position	L/R	Note # (pg 6)
70750	Gas Ryder		1.1	Honda	Fit	(Gen 1) (GD1)	07 on	Front	R	
70751	Gas Ryder		1.1	Toyota	Yaris Vitz	Yaris/Vitz	99-05	Front	←→	
70752	Gas Ryder		1.1	Toyota	Bubble	(1NZ)	02-07	Front	L	
70753	Gas Ryder		1.1	Toyota	Bubble	(1NZ)	02-07	Front	R	
70754	Gas Ryder		1.1	Toyota	Ipsum	(ACM 2)	01 on	Front	L	
70755	Gas Ryder		1.1	Toyota	Ipsum	(ACM 2)	01 on	Front	R	
70757	Gas Ryder		1.1	Chevrolet	Utility	Utility Pick-Up	11 on	Front	←→	
70763	Gas Ryder		1.1	Peugeot	207	Hatch, CC 1.6 Sport 2 EU5, GT 1.6 3-dr	06 on	Front	L	
70764	Gas Ryder		1.1	Peugeot	207	Hatch, CC 1.6 Sport 2 EU5, GT 1.6 3-dr	06 on	Front	R	
70771	Gas Ryder		1.1	Ford	Focus	Mk III Hatch & Sedan (Excl. 2.5 ST & RS)	11 on	Front	L	
70772	Gas Ryder		1.1	Ford	Focus	Mk III Hatch & Sedan (Excl. 2.5 ST & RS)	11 on	Front	R	
70775	Gas Ryder		1.1	Volkswagen	Jetta	6 Sedan (55mm OD)	11 on	Front	←→	
70785	Gas Ryder		1.1	Volvo	S60	Sedan	00-10	Front	←→	
70786	Gas Ryder		1.1	Mercedes-Benz	E Class	(W212) Sedan	09 on	Front	←→	
70789	Gas Ryder		1.1	BMW	3 Series	E92 Series	07-14	Front	L	
70790	Gas Ryder		1.1	BMW	3 Series	E92 Series	07-14	Front	R	
70793	Gas Ryder		1.1	Hyundai	Elantra	HD Sedan	06-10	Front	L	
70794	Gas Ryder		1.1	Hyundai	Elantra	HD Sedan	06-10	Front	R	
70795	Gas Ryder		1.1	Kia	Cerato	Hatch & Sedan	09-13	Front	L	
70796	Gas Ryder		1.1	Kia	Cerato	Hatch & Sedan	09-13	Front	R	
70800	Gas Ryder		1.1	Chevrolet	Spark	M200, M250 Hatch	06-10	Front	L	
70801	Gas Ryder		1.1	Chevrolet	Spark	M200, M250 Hatch	06-10	Front	R	
70802	Gas Ryder		1.1	Toyota	Yaris	Hatch	11 on	Front	L	
70803	Gas Ryder		1.1	Toyota	Yaris	Hatch	11 on	Front	R	
70806	Gas Ryder		1.1	Nissan	Micra	Hatch	11 on	Front	L	
70807	Gas Ryder		1.1	Nissan	Micra	Hatch	11 on	Front	R	
70808	Gas Ryder		1.1	Mercedes-Benz	C Class	(CLC 203) Coupe	00-11	Front	←→	
70809	Gas Ryder		1.1	Renault	Clio	Clio II 1.6 16V Sport	00-06	Front	←→	
70810	Gas Ryder		1.1	Hyundai	Accent	Sedan	11-13	Front	L	
70811	Gas Ryder		1.1	Hyundai	Accent	Sedan	11-13	Front	R	
70814	Gas Ryder		1.1	BMW	5 Series	E60 Series Sedan	04-10	Front	L	
70815	Gas Ryder		1.1	BMW	5 Series	E60 Series Sedan	04-10	Front	R	
70816	Gas Ryder		1.1	Mazda	Demio	DF	03 on	Front	L	
70817	Gas Ryder		1.1	Mazda	Demio	DF	03 on	Front	R	
70822	Gas Ryder		1.1	Ford	Fiesta	Mk VI	08 on	Front	L	
70823	Gas Ryder		1.1	Mazda	Mazda 2	Hatch DE (Demio)	07 on	Front	L	

70750 - 70823



70833

PARTS LISTING

Shocks & Struts

70833 – 76008

Part #	Range	Superceding Part#/Status	Product Type	Make	Model	Derivative	Year	Position	L/R	Note # (pg 6)
70833	Gas Ryder		† 1,1	Nissan	Juke	(F15) All	11 on	Front	L	
70834	Gas Ryder		† 1,1	Nissan	Juke	(F15) All	11 on	Front	R	
76006	Fleet Ryder		‡ 5	Bussing	19L, BBL	Truck	19...	Front	↔	
				ERF	E6 (Air Susp.)	Truck	19...	Front	↔	
				International	S2670-407T, S Series	Truck	80-85	Front	↔	
				Leyland	Buffalo	Truck	19...	Front	↔	
				Leyland	Eland	Bus	19...	Front	↔	
				Leyland	Pioneer Plus	Truck	19...	Front	↔	
				Leyland	Road Train	Truck	19...	Front	↔	
				Isuzu	BD	Bus	74 on	Rear	↔	
				Leyland	Eland	Bus	19...	Rear	↔	
				Leyland	Guy Victory J, Mk II	Bus	19...	Rear	↔	
				Leyland	Kudu 352 RA, A691	Bus	19...	Rear	↔	
				Scania	LB 81 HS-31/50 4x2	Truck	75-82	Rear	↔	
				Scania	LBT 111-HS31 6x4	Truck	75-82	Rear	↔	
				Scania	LBT 141 HS-31/46 6x4	Truck	78-82	Rear	↔	
Scania	P82ML 4x2(S) 4x2	Truck	82-89	Rear	↔					
76007	Fleet Ryder		⊙ 8,2	DAF	AT1900	Truck	19...	Front	↔	
				Isuzu	SFR, TD	Truck	72 on	Front	↔	31
				DAF	AT1900	Truck	19...	Rear	↔	
				Ford	D1210, D1211	Truck	78-82	Rear	↔	
				Ford	D1311, D1414	Truck	72-82	Rear	↔	
				Ford	DA 2114	Truck	74-82	Rear	↔	
				Ford	DO 607, DO 807	Truck	73-82	Rear	↔	
				Ford	DO 910, D1010	Truck	71-82	Rear	↔	
				Ford	DT 2014	Truck	72-82	Rear	↔	
76008	Fleet Ryder		⊙ 8,2	International	E-Line	Truck	19...	Front	↔	
				Volvo	F12, FL12, FH12	Truck	19...	Front	↔	

PARTS LISTING

Shocks & Struts

76009



76009 - 76015

Part #	Range	Superceding Part #/Status	Product Type	Make	Model	Derivative	Year	Position	L/R	Note # (pg 6)
76009	Fleet Ryder		† 5	Bedford	VAM	Bus	76 on	Front	↔	
				Ford	D1210, D1211	Truck	78-82	Front	↔	
				Ford	D1311, D1414	Truck	72-82	Front	↔	
				Ford	DA 2114	Truck	74-82	Front	↔	
				Ford	DO 607, DO 807	Truck	73-82	Front	↔	
				Ford	DO 910, D1010	Truck	71-82	Front	↔	
				Ford	DT 2014	Truck	72-82	Front	↔	
				International	4700, 4900 (4x2), 4900 (6x4)	Truck	93 on	Front	↔	
				Leyland	AEC Mk IV	Bus	19...	Front	↔	
				Leyland	Clydesdale CD23	Bus	19...	Front	↔	
				Leyland	Eland EL 4114, 14.12	Truck	73-85	Front	↔	
				Leyland	Mammoth Major, Mandator	Truck	19...	Front	↔	
				Leyland	Monarch, 2TG4RE	Truck	19...	Front	↔	
				Leyland	Worldmaster	Bus	19...	Front	↔	
				Mercedes-Benz	0, 317	Bus	19...	Front	↔	
				Mercedes-Benz	0.302, 0.305 (Air Susp.)	Bus	19...	Front	↔	
Leyland	Tiger	Bus	19...	Rear	↔					
Mercedes-Benz	0.302, 0.305 (Air Susp.)	Bus	19...	Rear	↔					
76014	Fleet Ryder		⊙ 8,5	Mack	786FS	Truck	19...	Front	↔	
				Unimog	Buffel	414, 416 Truck	19...	Front	↔	
				Unimog	Buffel	414, 416 Truck	19...	Rear	↔	
76015	Fleet Ryder		⊙ 8,2	Bedford	4x4	Truck	70-80	Front	↔	
				Bedford	ELR4, ELR6, ELRA, ELR8	Truck	75-79	Front	↔	
				Bedford	KE, KG, KH All	Truck	64 on	Front	↔	
				Bedford	MFR	Truck	67-71	Front	↔	
				Bedford	VAL	Bus	66 on	Front	↔	
				International	Fleetstar	Truck	19...	Front	↔	
				International	Loadstar 1850	Truck	71-78	Front	↔	
				Peterbilt	320	Truck	95 on	Front	↔	
				Peterbilt	377A/E	Truck	95 on	Front	↔	
				Bedford	4x4	Truck	70-80	Rear	↔	
				Bedford	KE, KG, KH All	Truck	64 on	Rear	↔	
				Bedford	MFR	Truck	67-71	Rear	↔	
				Isuzu	N2800 P	Truck	93 on	Rear	↔	29
				Isuzu	N3000 P	Truck	87-90	Rear	↔	29
				Isuzu	NKR55/99	Truck	19...	Rear	↔	29
Isuzu	TL40-50	Truck	75 on	Rear	↔	29				
Isuzu	TLD44, TLD54	Truck	77-89	Rear	↔	29				



Part #	Range	Superceding Part#/Status	Product Type	Make	Model	Derivative	Year	Position	L/R	Note # (pg 6)
76016	Fleet Ryder		6,1	Isuzu	CVR, EXR, FT	Truck	89 on	Front	←→	
				Isuzu	F8000 (TN), F9000 (TT)	Truck	88 on	Front	←→	
				Isuzu	FSR700	Truck	96 on	Front	←→	
				Isuzu	SPZ, SHZ, SPR, SHR	Truck	80 on	Front	←→	
				Leyland	Marathon	Truck	76-83	Front	←→	
				Nissan	CM 12/CM14	Truck	87 on	Front	←→	
				Nissan	CM 16 N	Truck	90 on	Front	←→	
				Scania	80, 110	Truck	19...	Front	←→	
				Scania	LB 81 HS-31/50 4x2	Truck	75-82	Front	←→	
				Scania	LBT 111-HS31 6x4	Truck	75-82	Front	←→	
				Scania	LBT 141 HS-31/46 6x4	Truck	78-82	Front	←→	
				Toyota	DA 110, 116	Truck	73 on	Front	←→	
76017	Fleet Ryder		8,2	Western Star	3842S	Truck	19...	Front	←→	26
				Western Star	4842S, 4864S	Truck	19...	Front	←→	26
				Western Star	5964F, 5964F	Truck	19...	Front	←→	26
				Fiat	130NR	Truck	77-83	Front	←→	
				Fiat	682 SWB	Truck	19...	Front	←→	
				Fiat	684N, 684T	Truck	71-81	Front	←→	
				Oshkosh	E - 1344 T 290	Truck	78-83	Front	←→	
				Oshkosh	E - 1446 T 350	Truck	80-83	Front	←→	
76019	Fleet Ryder		8,5	Man	16, 281	Bus	19...	Front	←→	
				Mercedes-Benz	1113B, L, LK	Truck	68-94	Front	←→	
				Mercedes-Benz	1113B, LS	Truck	68-94	Front	←→	
				Mercedes-Benz	1313, L, LK	Truck	72-76	Front	←→	
				Mercedes-Benz	1313LS	Truck	19...	Front	←→	
				Mercedes-Benz	1317L, LK	Truck	19...	Front	←→	
				Mercedes-Benz	1513, 1517LS	Truck	19...	Front	←→	
				Mercedes-Benz	1513L, LK	Truck	70-75	Front	←→	
				Mercedes-Benz	1517, 1519, L, LK	Truck	75-80	Front	←→	
				Mercedes-Benz	1621, L, LK, LS	Truck	77-79	Front	←→	
				Mercedes-Benz	1624, L, LK, LAK, LS, LAS	Truck	19...	Front	←→	
				Mercedes-Benz	1921, L, LK, LS	Truck	70-77	Front	←→	
				Mercedes-Benz	1924, L, LK, LA, LAK, LS, LAS	Truck	19...	Front	←→	
				Mercedes-Benz	911B, L, LK	Truck	19...	Front	←→	
				Mercedes-Benz	911B, LS	Truck	19...	Front	←→	
				Bussing	14, 15 AK	Truck	19...	Rear	←→	
				Mercedes-Benz	Powerliner 1729S/32	Truck	94 on	Rear	←→	
Mercedes-Benz	Powerliner 1735S/35	Truck	92 on	Rear	←→					

PARTS LISTING

Shocks & Struts

76020



Part #	Range	Superceding Part #/Status	Product Type	Make	Model	Derivative	Year	Position	L/R	Note # (pg 6)
76020	Fleet Ryder		† 5	Leyland	Crusader	Truck	19...	Front	↔	
				Leyland	Guy Victory J, Mk II	Bus	19...	Front	↔	
				Leyland	Tiger	Bus	19...	Front	↔	
				DAF	FTT 2800 DKTD	Truck	75-82	Rear	↔	
				Leyland	Leopard	Truck	19...	Rear	↔	
				Man	16, 201	Truck	19...	Rear	↔	
				Man	16.220	Bus	19...	Rear	↔	
				Mercedes-Benz	0, 317	Bus	19...	Rear	↔	
				Mercedes-Benz	OH 1725L/59	Bus	19...	Rear	↔	
				Mercedes-Benz	OH 1835L/30	Bus	19...	Rear	↔	
				Scania	Bus	Bus	19...	Rear	↔	
76021	Fleet Ryder		∞ 8,5	Man	16, 201	Truck	19...	Front	↔	
				Man	16.220	Bus	19...	Front	↔	
				Man	30.280 DHT	Truck	78-84	Front	↔	
				Mercedes-Benz	1418, L, LK	Truck	68-79	Front	↔	
				Mercedes-Benz	1618, L, LK	Truck	19...	Front	↔	
				Mercedes-Benz	1620, L, LK	Truck	19...	Front	↔	
				Mercedes-Benz	1623, L, LK, LAK	Truck	19...	Front	↔	
				Mercedes-Benz	1918, 1920, L, LK	Truck	19...	Front	↔	
				Mercedes-Benz	1923L, LK	Truck	19...	Front	↔	
				Mercedes-Benz	2220, L, LA, LS, LAS	Truck	19...	Front	↔	
				Mercedes-Benz	2620, L, LA, LS, LAS	Truck	19...	Front	↔	
				Mercedes-Benz	2623, L, LS, LK, LA, LAS, LAK	Truck	19...	Front	↔	
				Mercedes-Benz	2629, LA, LAK, LAS	Truck	19...	Front	↔	
Mercedes-Benz	1113, L, LK, LF, LP, LPK	Truck	68-94	Rear	↔	30				
76022	Fleet Ryder		∞ 8,5	Mercedes-Benz	1313, L, LK	Truck	72-76	Rear	↔	
				Mercedes-Benz	1317L, LK	Truck	19...	Rear	↔	
				Mercedes-Benz	1317LP, LPK	Truck	19...	Rear	↔	
				Mercedes-Benz	1319LP, LPK	Truck	19...	Rear	↔	
				Mercedes-Benz	1413L, LK, LS	Truck	76-82	Rear	↔	
				Mercedes-Benz	1513, 1517LP, LPK	Truck	19...	Rear	↔	
				Mercedes-Benz	1513L, LK	Truck	70-75	Rear	↔	
				Mercedes-Benz	1517, 1519, L, LK	Truck	75-80	Rear	↔	
				Mercedes-Benz	1517, 1519, LAS	Truck	19...	Rear	↔	
				Mercedes-Benz	1617, LP, LPK	Truck	19...	Rear	↔	
				Mercedes-Benz	1619, LP	Truck	19...	Rear	↔	
				Mercedes-Benz	352 F	Bus	19...	Rear	↔	
				Mercedes-Benz	OF 1113, 1313, 1317/51, 1413, 1417/52, 1617	Bus	19...	Rear	↔	

76020 - 76022



76033

PARTS LISTING

Shocks & Struts

76033

Part #	Range	Superceding Part#/Status	Product Type	Make	Model	Derivative	Year	Position	L/R	Note # (pg 6)
76033	Fleet Ryder		8,5	Bussing	16L, LBL, LU, UK	Truck	19...	Front	←→	
				Man	30.330 DFT/DFTS/DFL	Truck	84-89	Front	←→	
				Mercedes-Benz	1735	Truck	19...	Front	←→	
				Mercedes-Benz	1113B, LA, LAK	Truck	73-83	Front	←→	
				Mercedes-Benz	1113B, LAS	Truck	73-83	Front	←→	
				Mercedes-Benz	1213, 1213K, 1217, 1217K	Truck	79-94	Front	←→	
				Mercedes-Benz	1313, LAK, LAS, LA	Truck	19...	Front	←→	
				Mercedes-Benz	1413L, 1413K, 1417, 1417K	Truck	82-93	Front	←→	
				Mercedes-Benz	1419, 1419K, 1419S	Truck	77-88	Front	←→	
				Mercedes-Benz	1513LA, LAK	Truck	19...	Front	←→	
				Mercedes-Benz	1517, 1519, LA, LAK	Truck	76-94	Front	←→	
				Mercedes-Benz	1517, 1519, LAS	Truck	19...	Front	←→	
				Mercedes-Benz	1617, LP, LPK	Truck	19...	Front	←→	
				Mercedes-Benz	1619, LP	Truck	19...	Front	←→	
				Mercedes-Benz	1813L	Truck	19...	Front	←→	
				Mercedes-Benz	1817, 1819, L	Truck	19...	Front	←→	
				Mercedes-Benz	1926S, 1928, 1928S, 1933S	Truck	81-92	Front	←→	
				Mercedes-Benz	2017, 2019, L, LB	Truck	19...	Front	←→	
				Mercedes-Benz	2233S	Truck	82-86	Front	←→	
				Mercedes-Benz	2624, A, AK, K, S	Truck	81-88	Front	←→	
				Mercedes-Benz	2624, L, LS, LK, LAK, LAS, LB, LAB	Truck	70-81	Front	←→	
				Mercedes-Benz	2628K, A, S	Truck	81-93	Front	←→	
				Mercedes-Benz	2632, L, K, AK, S, AS	Truck	75-83	Front	←→	
				Mercedes-Benz	2633S, 2636S, 2638S	Truck	83-93	Front	←→	
				Mercedes-Benz	2644S/32	Truck	94 on	Front	←→	
				Mercedes-Benz	3328S, 3333S	Truck	87-92	Front	←→	
				Mercedes-Benz	911B, LA, LAK	Truck	19...	Front	←→	
				Mercedes-Benz	911B, LAS	Truck	19...	Front	←→	
				Mercedes-Benz	Actros 1831LS/36, 1835/36	Truck	19...	Front	←→	
				Mercedes-Benz	Actros 2031 S/36	Truck	99 on	Front	←→	
				Mercedes-Benz	Actros 2643 LS/33, 2649LS/32	Truck	99 on	Front	←→	
				Mercedes-Benz	Actros 3335S/33	Truck	99 on	Front	←→	
Mercedes-Benz	Actros 3343 S/33	Truck	99 on	Front	←→					
Mercedes-Benz	Atego 1017/48, 48AK/36	Truck	19...	Front	←→					
Mercedes-Benz	Econoliner 1014/48, 1214/48	Truck	95 on	Front	←→					



Part #	Range	Superceding Part #/Status	Product Type	Make	Model	Derivative	Year	Position	L/R	Note # (pg 6)
76033	Fleet Ryder		8,5	Mercedes-Benz	Econoliner 1414K/36, 1414/48	Truck	92 on	Front	↔	
				Mercedes-Benz	Econoliner 1617/48 & 52	Truck	94 on	Front	↔	
				Mercedes-Benz	Econoliner 1617A/36, 1617K/36	Truck	92 on	Front	↔	
				Mercedes-Benz	Econoliner 1623S/36	Truck	96 on	Front	↔	
				Mercedes-Benz	L1013, 1013K, 1014	Truck	81-87	Front	↔	
				Mercedes-Benz	LA1213B	Truck	79-89	Front	↔	
				Mercedes-Benz	OH 1725L/59	Bus	19...	Front	↔	
				Mercedes-Benz	OH 1835L/30	Bus	19...	Front	↔	
				Mercedes-Benz	Powerliner 1729S/32	Truck	94 on	Front	↔	
				Mercedes-Benz	Powerliner 1735S/35	Truck	92 on	Front	↔	
				Mercedes-Benz	Powerliner 2426B/32 & 52	Truck	92 on	Front	↔	
				Mercedes-Benz	Powerliner 2535S/32	Truck	94 on	Front	↔	
				Mercedes-Benz	Powerliner 2545S/32	Truck	96 on	Front	↔	
				Mercedes-Benz	Powerliner 2629K/32, 2629S/32, 2629/45	Truck	92 on	Front	↔	
				Mercedes-Benz	Powerliner 2635S/32, 2635/45	Truck	92 on	Front	↔	
				Mercedes-Benz	Powerliner 2638S/32	Truck	95 on	Front	↔	
				Mercedes-Benz	Powerliner 3836K/38	Truck	19...	Front	↔	
				Mercedes-Benz	1735	Truck	19...	Rear	↔	
Mercedes-Benz	1926S, 1928, 1928S, 1933S	Truck	81-92	Rear	↔					
76034	Fleet Ryder		5	Ford	Cargo 0608, 0808	Truck	82-86	Front	↔	
				Ford	Cargo 0912, 1112, 1113	Truck	82-86	Front	↔	
				Ford	Cargo 1212, 1213	Truck	82-85	Front	↔	
				Ford	Cargo 1312, 1313	Truck	82-86	Front	↔	
				Ford	Cargo 1317, 1517	Truck	82-86	Front	↔	
				Ford	Cargo 2217	Truck	82-86	Front	↔	
				Bussing	22L, BLL (Tag Axle)	Truck	19...	Rear	↔	
				DAF	FA2200, F2200	Truck	72-80	Rear	↔	
				Scania	P112H (6X2)	Truck	82-89	Rear	↔	
				Scania	P142H (6X2)	Truck	82-89	Rear	↔	
				Scania	R112HL 6x4(S)	Truck	82-89	Rear	↔	
				Scania	R142H (6x4)	Truck	82-89	Rear	↔	

76033 - 76034



76035

PARTS LISTING

Shocks & Struts

76035 - 76041

Part #	Range	Superceding Part#/Status	Product Type	Make	Model	Derivative	Year	Position	L/R	Note # (pg 6)
76035	Fleet Ryder		6,1	DAF	FA2200, F2200	Truck	72-80	Front	←→	
				DAF	FTT 2800 DKTD	Truck	75-82	Front	←→	
				ERF	ERF	Truck	19...	Front	←→	
				Scania	112, 142	Truck	19...	Front	←→	
				Scania	K94	Bus	19...	Front	←→	
				Scania	P112H (6X2)	Truck	82-89	Front	←→	
				Scania	P114GA 6x4 NZ 380	Truck	19...	Front	←→	
				Scania	P124 CB 6x4 NZ 470	Truck	19...	Front	←→	
				Scania	P124GA 400	Truck	19...	Front	←→	
				Scania	P124GA 6x4 NZ 420, 470	Truck	19...	Front	←→	
				Scania	P124LA 6x2 NA 420	Truck	19...	Front	←→	
				Scania	P142H (6X2)	Truck	82-89	Front	←→	
				Scania	P82ML 4x2(S) 4x2	Truck	82-89	Front	←→	
				Scania	P94LA 4x2 NA 310	Truck	19...	Front	←→	
				Scania	R112HL 6x4(S)	Truck	82-89	Front	←→	
Scania	R142H (6x4)	Truck	82-89	Front	←→					
Nissan	CB 20	Bus	19...	Rear	←→					
76036	Fleet Ryder		8,5	Mercedes-Benz	352 F	Bus	19...	Front	←→	
				Mercedes-Benz	OF 1113, 1313, 1317/51, 1413, 1417/52, 1617	Bus	19...	Front	←→	
76039	Fleet Ryder		8,5	Mercedes-Benz	1113, L, LK, LF, LP, LPK	Truck	68-94	Front	←→	30
				Mercedes-Benz	1418, LP, LPS	Truck	19...	Front	←→	
76040	Fleet Ryder		8,5	Mack	R600RST, F700RST Series	Truck	73-85	Front	←→	
76041	Fleet Ryder		5	Leyland	Guy Victory J, Mk I	Bus	19...	Front	←→	
				Leyland	Kudu 352 RA, A691	Bus	19...	Front	←→	
				Leyland	Leopard	Truck	19...	Front	←→	
				Leyland	Super Comet	Truck	19...	Front	←→	
				Leyland	Super Eland 22.12, 24.12	Truck	75-85	Front	←→	
				Nissan	CM 90	Truck (Condor)	19...	Front	←→	

PARTS LISTING

Shocks & Struts

76042



Part #	Range	Superceding Part #/Status	Product Type	Make	Model	Derivative	Year	Position	L/R	Note # (pg 6)
76042	Fleet Ryder		8,2	Bedford	KM All	Truck	72 on	Front	↔	
				Hino	55/330, 55/350	Truck	85-94	Front	↔	
				Hino	C40	Truck	93 on	Front	↔	
				Hino	FF13-133, FF14-173	Truck	83-94	Front	↔	
				Hino	GD, Super Dolphin	Truck	19...	Front	↔	
				Hino	KB 302, 342, 14-177	Truck	72-84	Front	↔	
				International	Acco 1600, 1830C	Truck	84-85	Front	↔	
				International	Acco 1840D Mk II	Truck	79-83	Front	↔	
				International	Paystar F5070/350	Truck	73-84	Front	↔	
				International	Transtar COF-4070	Truck	75-79	Front	↔	
				International	Unistar R91	Truck	19...	Front	↔	
				Isuzu	BD	Bus	74 on	Front	↔	
				Isuzu	SLR, VPR	Truck	72 on	Front	↔	
				Isuzu	SPZ	Truck	73-80	Front	↔	
				Leyland	AEC Mk IV (With Air Cushions)	Bus	19...	Front	↔	
				Leyland	AEC Mk IV (Without Air Cushions)	Bus	19...	Front	↔	
				Leyland	Chieftain CH 4013, 14.10	Truck	79-86	Front	↔	
				Leyland	Mastiff	Truck	19...	Front	↔	
				Oshkosh	R Series	Truck	19...	Front	↔	
				Volvo	B7F	Bus	19...	Front	↔	
				Volvo	F88, G88	Truck	19...	Front	↔	
				Western Star	3842S	Truck	19...	Front	↔	26
				Western Star	4842S, 4864S	Truck	19...	Front	↔	26
				Western Star	5964F, 5964F	Truck	19...	Front	↔	26
				Ford	Cargo 0608, 0808	Truck	82-86	Rear	↔	
				Ford	Cargo 0912, 1112, 1113	Truck	82-86	Rear	↔	
				Ford	Cargo 1212, 1213	Truck	82-85	Rear	↔	
				Ford	Cargo 1312, 1313	Truck	82-86	Rear	↔	
				Ford	Cargo 1317, 1517	Truck	82-86	Rear	↔	
				Ford	Cargo 2217	Truck	82-86	Rear	↔	
				International	Unistar R91	Truck	19...	Rear	↔	
				Leyland	AEC Mk IV (With Air Cushions)	Bus	19...	Rear	↔	
				Leyland	Eland EL 4114, 14.12	Truck	73-85	Rear	↔	
				Leyland	Guy Victory J, Mk I	Bus	19...	Rear	↔	
				Silver Eagle	SAR Coach	Bus	19...	Rear	↔	
				Volvo	B7F	Bus	19...	Rear	↔	

76042



Part #	Range	Superceding Part #/Status	Product Type	Make	Model	Derivative	Year	Position	L/R	Note # (pg 6)
76043	Fleet Ryder		1/6 6,1	Isuzu	FTR800	Truck	96 on	Front	←→	
				Isuzu	FVZ1400	Truck	94 on	Front	←→	
				Leyland	Swift	Bus	19...	Front	←→	
				Toyota	DA/ KA	Truck	00 on	Front	←→	
				Isuzu	SBR 422, FJR	Truck	76-83	Rear	←→	
76102	Fleet Ryder		1/6 6,1	Hino	FE	Truck	83 on	Front	←→	
				Hino	KR 320, 360	Truck	74-84	Front	←→	
				Isuzu	CVR, 49N	Truck	79-89	Front	←→	
				Isuzu	F5000 (FN), F6599 (FN)	Truck	88 on	Front	←→	
				Nissan	UG 80	Bus	19...	Front	←→	
				Nissan	UG780, UD780	Truck	69 on	Front	←→	
76103	Fleet Ryder		1/6 6,1	Bedford	YRT	Bus	19...	Front	←→	
				ERF	Trailblazer	Truck	19...	Front	←→	32
				Isuzu	FVR2200 Turbo	Truck	93 on	Front	←→	
				Isuzu	FVR900 Turbo	Truck	93 on	Front	←→	
				Man	M2000 15.223L, 16.223L, K, LA	Truck	19...	Front	←→	
				Nissan	CB 20	Bus	19...	Front	←→	
				Nissan	CK10 K/A	Truck	74-86	Front	←→	
				Nissan	CK20 D/L/N	Truck	73-83	Front	←→	
				Nissan	CK25D/N	Truck	83-84	Front	←→	
				Nissan	CK41 CT	Truck	80-85	Front	←→	
				Nissan	CM 15 E	Truck	87-92	Front	←→	
				Nissan	CW 350 HTA, HTF	Truck	93 on	Front	←→	
				Nissan	CW290 HDN, PHN	Truck	93 on	Front	←→	
				Nissan	CW290 PPA, HTA, HTF, CK290 CTA	Truck	93-95	Front	←→	
				Nissan	CW41 H/P	Truck	77-85	Front	←→	
				Nissan	CW45 HD/PA	Truck	82-89	Front	←→	
				Nissan	CW46 HDN, HTF, HMF, HTA, PAN	Truck	89-93	Front	←→	
				Nissan	CW46 PAF, PAA	Truck	89-92	Front	←→	
				Nissan	CW47 HDN, HTA, HTF, PAF, PAN	Truck	93-95	Front	←→	
				Nissan	CW55 HTF, CW56 HTF	Truck	89-95	Front	←→	
ERF	Trailblazer	Truck	19...	Rear	←→	32				
Leyland	Marathon	Truck	76-83	Rear	←→					

PARTS LISTING

Shocks & Struts

76104



Part #	Range	Superceding Part #/Status	Product Type	Make	Model	Derivative	Year	Position	L/R	Note # (pg 6)
76104	Fleet Ryder		8,5	Mercedes-Benz	1113B, LAS	Truck	73-83	Rear	↔	
				Mercedes-Benz	1113B, LS	Truck	68-94	Rear	↔	
				Mercedes-Benz	1313, LAK, LAS, LA	Truck	19...	Rear	↔	
				Mercedes-Benz	1313LS	Truck	19...	Rear	↔	
				Mercedes-Benz	1513, 1517LS	Truck	19...	Rear	↔	
				Mercedes-Benz	1513LA, LAK	Truck	19...	Rear	↔	
				Mercedes-Benz	1517, 1519, LA, LAK	Truck	76-94	Rear	↔	
				Mercedes-Benz	911B, LAS	Truck	19...	Rear	↔	
				Mercedes-Benz	911B, LS	Truck	19...	Rear	↔	
				Mercedes-Benz	LA1213B	Truck	79-89	Rear	↔	
				Mercedes-Benz	OF 1621, 1624	Bus	86 on	Rear	↔	
76106	Fleet Ryder		8,5	Mercedes-Benz	1213AK	Truck	79-94	Front	↔	
				Mercedes-Benz	2219, 2219K, 2224	Truck	82-93	Front	↔	
				Mercedes-Benz	2224B, 2225B	Truck	86-93	Front	↔	
76108	Fleet Ryder		6,1	Isuzu	JCR 500	Truck	19...	Front	↔	
				Isuzu	N 3500 D, N4000 D	Truck	86 on	Front	↔	
				Isuzu	NPR 300, 400	Truck	86 on	Front	↔	
76109	Fleet Ryder		8,5	Mercedes-Benz	OF 1621, 1624	Bus	86 on	Front	↔	
76110	Fleet Ryder		8,2	Isuzu	N 3500 D, N4000 D	Truck	86 on	Rear	↔	
				Isuzu	NPR 300, 400	Truck	86 on	Rear	↔	
76131	Fleet Ryder		6,2	Man	27, 463	Truck	19...	Front	↔	
				Man	19.292 FT/FTS	Truck	90-94	Front	↔	
				Man	19.300FT, 19.320, 19.321 FT/FTS	Truck	85-90	Front	↔	
				Man	19.362 FTS	Truck	89-93	Front	↔	
				Man	26.292 DFT/DFTS/DFL/DFK	Truck	89 on	Front	↔	
				Man	26.362 DFTS/DFLS	Truck	90 on	Front	↔	
				Man	26.372 DFT/DFTS	Truck	90-95	Front	↔	
				Man	26.402 DFTS, 422	Truck	93 on	Front	↔	
				Man	26.442, 26.552 DFTS	Truck	90 on	Front	↔	
				Man	29.292 DFT/DFTS/DFL/DFK	Truck	89-92	Front	↔	
				Man	30.365 DFT/DFTS/DFL	Truck	86-89	Front	↔	
				Man	30.380 DFT/DFTS/DFL	Truck	84-89	Front	↔	
				Man	30.440 DFTS/DFL	Truck	87-90	Front	↔	
				Man	F2000 27.463TS, 27.464 TS	Truck	19...	Front	↔	
				Man	F2000 33.373KN, TN	Truck	19...	Front	↔	
				Man	F2000 33.374K, L, T	Truck	19...	Front	↔	
				Man	F2000 33.423TS	Truck	19...	Front	↔	
Man	F2000 40.464 TS	Truck	19...	Front	↔					

76104 - 76131



76132

PARTS LISTING

Shocks & Struts

76132 - 77006

Part #	Range	Superceding Part #/Status	Product Type	Make	Model	Derivative	Year	Position	L/R	Note # (pg 6)
76132	Fleet Ryder		6,1	Hino	FD 10-135	Truck	83-94	Front	←→	
				Hino	KL 340, KL360	Truck	72-83	Front	←→	
				Isuzu	NKR	Truck	96 on	Front	←→	
				Isuzu	SBR 422, FJR	Truck	76-83	Front	←→	
76151	Fleet Ryder		6,2	International	9800 Eagle	Truck (Set back Axle)	19...	Front	←→	
76156	Fleet Ryder		6,2	Iveco	Eurotech	MPL440E42T, 440E 34, 38, 42, 52	92 on	Front	←→	
76157	Fleet Ryder		8,5	Iveco	Eurotech	MPL440E42T, 440E 34, 38, 42, 52	92 on	Rear	←→	
76185	Fleet Ryder		8,5	Tata	LPT 1518TC	Truck	05 on	Front	←→	
76186	Fleet Ryder		8,5	Tata	LPT 1518TC	Truck	05 on	Rear	←→	
76204	Fleet Ryder		6,1	Isuzu	FTR800 4x2 FC	Truck	97 on	Front	←→	
76205	Fleet Ryder		6,1	Nissan	UD 80 4x2 F-C	Truck	97 on	Front	←→	
76206	Fleet Ryder		5	Nissan	UD 80 4x2 F-C	Truck	97 on	Rear	←→	
76207	Fleet Ryder		8,2	Hino	500	1626 Series	97 on	Front	←→	
76208	Fleet Ryder		8,5	Iveco	Daily	P-Van 107 KW-D (50C15, 65C15, 70C15)	04 on	Front	←→	
				Iveco	Daily	P-Van 92 KW-D (35S13, 50C13)	01-08	Front	←→	
76209	Fleet Ryder		8,5	Iveco	Daily	P-Van 107 KW-D (50C15, 65C15, 70C15)	04 on	Rear	←→	
				Iveco	Daily	P-Van 92 KW-D (35S13, 50C13)	01-08	Rear	←→	
77000	Fleet Ryder		5	Neoplan	Cityliner	Bus	19...	Front	←→	
				Neoplan	Cityliner	Bus	19...	Rear	←→	
77001	Fleet Ryder		6,2	Mercedes-Benz	1213, 1213K, 1217, 1217K	Truck	79-94	Rear	←→	
				Mercedes-Benz	1213AK	Truck	79-94	Rear	←→	
				Mercedes-Benz	1413L, 1413K, 1417, 1417K	Truck	82-93	Rear	←→	
				Mercedes-Benz	1419, 1419K, 1419S	Truck	77-88	Rear	←→	
				Mercedes-Benz	Econoliner 1617/48 & 52	Truck	94 on	Rear	←→	
				Mercedes-Benz	Econoliner 1617A/36, 1617K/36	Truck	92 on	Rear	←→	
				Mercedes-Benz	L1013, 1013K, 1014	Truck	81-87	Rear	←→	
77002	Fleet Ryder		8,2	Silver Eagle	SAR Coach	Bus	19...	Front	←→	
77003	Fleet Ryder		8,5	Man	16.240 FT/FTS/HT/HL/ HAL/HAK	Truck	76-89	Front	←→	
				Man	19.280 FT/FTS	Truck	78-90	Front	←→	
				Man	22/24.192 DHK, DHL	Truck	76-87	Front	←→	
				Man	M2000 14.153 L	Truck	19...	Front	←→	
77004	Fleet Ryder		5	DAF	FT 2200 DU	Truck	72-80	Front	←→	
77005	Fleet Ryder		8,5	Magnis	Msiza	Truck	19...	Front	←→	
77006	Fleet Ryder		5	Renault	CBH 385	Truck	96 on	Front	←→	

Be safe. Be sure

PARTS LISTING

Shocks & Struts

77007



Part #	Range	Superceding Part #/Status	Product Type	Make	Model	Derivative	Year	Position	L/R	Note # (pg 6)	
77007	Fleet Ryder		☉	8,5	Mercedes-Benz	1113B, LA, LAK	Truck	73-83	Front	↔	
					Mercedes-Benz	1113B, LAS	Truck	73-83	Front	↔	
					Mercedes-Benz	1313, LAK, LAS, LA	Truck	19...	Front	↔	
					Mercedes-Benz	1413L, 1413K, 1417, 1417K	Truck	82-93	Front	↔	
					Mercedes-Benz	1419, 1419K, 1419S	Truck	77-88	Front	↔	
					Mercedes-Benz	1513LA, LAK	Truck	19...	Front	↔	
					Mercedes-Benz	1517, 1519, LA, LAK	Truck	76-94	Front	↔	
					Mercedes-Benz	1517, 1519, LAS	Truck	19...	Front	↔	
					Mercedes-Benz	1813L	Truck	19...	Front	↔	
					Mercedes-Benz	1817, 1819, L	Truck	19...	Front	↔	
					Mercedes-Benz	1926S, 1928, 1928S, 1933S	Truck	81-92	Front	↔	
					Mercedes-Benz	2017, 2019, L, LB	Truck	19...	Front	↔	
					Mercedes-Benz	2624, A, AK, K, S	Truck	81-88	Front	↔	
					Mercedes-Benz	2628K, A, S	Truck	81-93	Front	↔	
					Mercedes-Benz	2632, L, K, AK, S, AS	Truck	75-83	Front	↔	
					Mercedes-Benz	2633S, 2636S, 2638S	Truck	83-93	Front	↔	
					Mercedes-Benz	3328S, 3333S	Truck	87-92	Front	↔	
					Mercedes-Benz	911B, LA, LAK	Truck	19...	Front	↔	
Mercedes-Benz	911B, LAS	Truck	19...	Front	↔						
Mercedes-Benz	LA1213B	Truck	79-89	Front	↔						
77008	Fleet Ryder		☉	8,5	Caspir	Caspir	Truck	19...	Rear	↔	
					Peterbilt	362 E 436, 460, 550	Truck	95 on	Front	↔	
					International	9800 Eagle	Truck (Set back Axle)	19...	Rear	↔	27
					International	9800 Eagle	Truck (Set forward Axle)	19...	Rear	↔	27
77022	Fleet Ryder		☉	8,5	Fiat	619T1	Truck	69-80	Front	↔	
					Freightliner	FL50, FL60, FL70, FL80	Truck	19...	Front	↔	
77024	Fleet Ryder		†	5	Train Shock	-	-	-	-		
81270	Heavy Duty	G56119	†	5	Nissan	Patrol	4x4 (G160)	80-89	Front	↔	
					Nissan	Patrol	4x4 (WG60)	72-80	Front	↔	
					Nissan	Patrol	4x4 (WG60)	72-80	Rear	↔	
83367	Heavy Duty		☉	9,2	Volkswagen	Caravelle	Caravelle T4	99-04	Rear	↔	
					Volkswagen	Kombi	Transporter T4: Mini bus, Pickup & P-Van Excl. Syncro	99-04	Rear	↔	
83373	Heavy Duty		☉	6,2	Volkswagen	Caravelle	Caravelle T4	99-04	Front	↔	
					Volkswagen	Kombi	Transporter T4: Mini bus, Pickup & P-Van Excl. Syncro	99-04	Front	↔	
83450	Heavy Duty		☉	8,5	Mercedes-Benz	Sprinter	412D (903)	95 on	Rear	↔	
					Mercedes-Benz	Sprinter 412D	Truck	96 on	Rear	↔	
83454	Heavy Duty		☉	6,1	Toyota	Prado	90 SWB & 95 LWB	96-02	Rear	↔	
83455	Heavy Duty		☉	6,2	Toyota	Landcruiser	HDJ100, UZJ100 (Excl. Air Susp.)	98-02	Front	↔	

77007 - 83455



Part #	Range	Superceding Part #/Status	Product Type	Make	Model	Derivative	Year	Position	L/R	Note # (pg 6)
83456	Heavy Duty		6,2	Toyota	Landcruiser	HDJ100, UZJ100 (Excl. Air Susp.)	98-02	Rear	←→	
				Toyota	Landcruiser	HDJ100/105, UZJ100/105 (Excl. Air Susp.)	98-02	Rear	←→	
85319	Heavy Duty		8,5	Freightliner	FL112 Series	Truck	19...	Rear	←→	28
85320	Heavy Duty		8,2	Freightliner	FL112 Series	Truck	19...	Front	←→	
85724	Heavy Duty		8,5	Freightliner	Argosy 90 (Air Susp.)	Truck	19...	Rear	←→	
				Freightliner	FL112 Series	Truck	19...	Rear	←→	28
85918	Heavy Duty		8,5	Freightliner	Argosy 90 (Air Susp.)	Truck	19...	Front	←→	
143057	Gabriel				Strut Cushion					
144273	Gabriel				Gas Filling Machine	Gaslifts				
144283	Gabriel				Hoses, Fittings And Trigger Valve	Gaslifts				
EG35046	Gas Ryder		1,1	BMW	Z3	E36/4	98-03	Front	L	
EG35047	Gas Ryder		1,1	BMW	Z3	E36/4	98-03	Front	R	
EG35115	Gas Ryder		1,1	Opel	Omega	Sedan, Estate (B)	01-04	Front	←→	
EG63659	Gas Ryder		8,4	Isuzu	Trooper	Mk II	92-96	Rear	←→	
G35112	Gas Ryder		1,1	Ford	Mondeo	Mk II	96-01	Rear	←→	
G35128	Gas Ryder		1,1	Volvo	850	Excl.	94-97	Front	←→	
				Volvo	850	Excl.	94-97	Front	←→	
G35146	Gas Ryder		1,1	Ford	Escort	Mk V, VI, VII	95-99	Front	←→	
				Ford	Escort	Mk V, VI, VII	95-99	Front	←→	
G35189	Gas Ryder		1,1	Ford	Mondeo	Mk II	96-01	Front	←→	
				Ford	Mondeo	Mk II (Excl. Self Levelling)	96-01	Front	←→	
G35190	Gas Ryder		1,1	Volkswagen	Sharan	Mk I, Mk IA, Mk IB	95-10	Front	←→	
G35214	Gas Ryder		1,1	Fiat	Palio	Type 1X	00-02	Front	←→	
				Fiat	Palio	Weekend (Type PY)	00-02	Front	←→	
				Fiat	Siena	Type 2A	00-02	Front	←→	
G35220	Gas Ryder		1,1	Volvo	S40	Excl. & T4 Rear (Mk I)	95-04	Front	L	
G35225	Gas Ryder		1,1	Volvo	S40	Excl. & T4 Rear (Mk I)	95-04	Front	R	
G35227	Gas Ryder		1,1	BMW	5 Series	E39 Series (535i, 540i) (Excl.	96-04	Front	←→	
G35228	Gas Ryder		1,1	BMW	5 Series	E39 Series (520i, 523i, 525i, 525TDS, 528i, 530i, 530D) (Excl.	96-04	Front	←→	
G35279	Gas Ryder		1,1	Fiat	Seicento	600	99-03	Front	←→	
G35289	Gas Ryder		1,1	Opel	Zafira	A	01-06	Front	L	
G35290	Gas Ryder		1,1	Opel	Zafira	A	01-06	Front	R	
G35292	Gas Ryder		1,1	Volvo	C70	Excl. T5 (Mk I)	97-05	Front	←→	
				Volvo	S70, V70	Excl.	97-00	Front	←→	
G35295	Gas Ryder		1,1	Daewoo	Matiz	Spark	99-03	Front	L	
G35296	Gas Ryder		1,1	Ford	Focus	Mk I Hatch & Sedan	98-04	Front	L	
G35300	Gas Ryder		1,1	Daewoo	Matiz	Spark	03-05	Front	R	

PARTS LISTING

Shocks & Struts

G35301



G35301 – G45006

Part #	Range	Superceding Part #/Status	Product Type	Make	Model	Derivative	Year	Position	L/R	Note # (pg 6)
G35301	Gas Ryder		1,1	Ford	Focus	Mk I Hatch & Sedan	98-04	Front	R	
G35305	Gas Ryder	70511	1	Renault	Megane	Mk I (Excl. Coupe)	96-03	Front	↔	
				Renault	Scenic	Mk I (Excl. 4x4)	98-04	Front	↔	
G35326	Gas Ryder		1,1	Ford	KA	1.3 (Mk I)	05-08	Front	↔	
G35337	Gas Ryder		1,1	Peugeot	206	1.4HDi, 2.0HDi	04-07	Front	R	
				Peugeot	206	1.6 Estate	03-07	Front	R	
				Peugeot	206	2.0 GTi	00-06	Front	R	
G35338	Gas Ryder		1,1	Peugeot	206	1.4HDi, 2.0HDi	04-07	Front	L	
				Peugeot	206	1.6 Estate	03-07	Front	L	
				Peugeot	206	2.0 GTi	00-06	Front	L	
G35365	Gas Ryder		1,1	Mercedes-Benz	A Class	(W168) A160, A190, 170CDI	00-04	Front	↔	
G35369	Gas Ryder		1,1	Peugeot	307	1.6, 2.0 Excl. CC	01-08	Front	L	
				Peugeot	307	Estate	02-08	Front	L	
G35370	Gas Ryder		1,1	Peugeot	307	1.6, 2.0 Excl. CC	01-08	Front	R	
				Peugeot	307	Estate	02-08	Front	R	
G35421	Gas Ryder		1,1	Renault	Megane	II Hatch (Excl. 2.0 T Sport)	04-08	Front	↔	
G35451	Gas Ryder		1,1	Renault	Scenic	Grand Scenic II	04-09	Front	↔	
				Renault	Scenic	Scenic II	04-09	Front	↔	
G44450	Gas Ryder	61303	2	Audi	100, 200	C2	77-84	Front	↔	
G44782	Gas Ryder		2	Toyota	Rav 4	Serviceable Struts (XA10)	96-98	Front	↔	
G45001	Technomatic		5	Toyota	TUV	LDV	82-87	Front	↔	
				Volvo	122	Amazon	62-71	Front	↔	
				Volvo	122	Amazon, B18	59-71	Front	↔	
G45006	Technomatic		8,2	Chevrolet	LUV	Faster	73-78	Rear	↔	
				Dodge (Chrysler)	Husky	LDV	74-78	Rear	↔	3
				Jeep (Chrysler)	Jeep	CJ Series (Willys) (CJ5, CJ6, CJ7)	54-86	Rear	↔	
				Fiat	124	Station Wagon	69-77	Rear	↔	
				Isuzu	KB (D-Max), TF Series	(Mk I)	78-80	Rear	↔	
				Isuzu	WFR, Relay	Fargo	80-95	Rear	↔	
				Nissan	Stanza	1600J, 1800J, Stanza S/W (A10)	79-83	Rear	↔	
				Toyota	Condor	4x4 Mk IV	00-05	Rear	↔	
				Toyota	Corona	T60, T70 Series (Mark II 1900)	69-73	Rear	↔	
				Toyota	Hiace	H10	69-84	Rear	↔	
				Toyota	Hilux	4x2	69-84	Rear	↔	
				Toyota	Stout	RK 101	61-89	Rear	↔	
Toyota	TUV	LDV	82-87	Rear	↔					



Part #	Range	Superceding Part#/Status	Product Type	Make	Model	Derivative	Year	Position	L/R	Note # (pg 6)
G45008	Technomatic		☉ 8,2	Isuzu	KB (D-Max), TF Series	4x2 (Standard Height) (TF)	89-04	Rear	←→	
				Isuzu	KB (D-Max), TF Series	4x4, 4x2 (Raised Height) (TF)	89-04	Rear	←→	
				Nissan	Laurel	240, 260, 300 (C130)	72-78	Rear	←→	13
				Toyota	Hilux	4x2 Standard Susp.	99-05	Rear	←→	
				Toyota	Hilux	4x4	79-84	Rear	←→	
				Toyota	Landcruiser	FJ45, BJ45	71-85	Rear	←→	
G45051	Technomatic		☉ 8,2	Jeep (Chrysler)	Jeep	CJ Series (Willys) (CJ5, CJ6, CJ7)	54-86	Front	←→	
				Toyota	Landcruiser	FJ45, BJ45	71-85	Front	←→	
				Ford	Husky	LDV, P-Van	86-93	Rear	←→	
				Hillman	Vogue, Hunter	Safari	67-77	Rear	←→	
				Hyundai	H100	Bakkie	96-05	Rear	←→	
				Mitsubishi	L300 (Delica)	Incl. Starwagon, Express	82-03	Rear	←→	
				Nissan	1 Ton Bakkie	720 4x2	80-88	Rear	←→	
				Nissan	1/2 Ton Bakkie	120Y (12" wheels)	76-83	Rear	←→	
				Nissan	1/2 Ton Bakkie	1400 (13" wheels)	80-83	Rear	←→	
				Nissan	1/2 Ton Bakkie	1400, 1200, 120Y	71-08	Rear	←→	
				Nissan	Caball	Truck	64-78	Rear	←→	
				Nissan	Vanette	C22	85-85	Rear	←→	
				Nissan	Y' Series	140Y, 160Y	75-80	Rear	←→	
				Toyota	Stallion	KF40	87-00	Rear	←→	
Toyota	Venture	KF40	91-00	Rear	←→					
G45054	Technomatic		☉ 8,2	Suzuki	SJ410/413, Samurai	4x4, S/W	82-87	Rear	←→	
				Toyota	Hiace	SWB (H20, H30, H40)	84-88	Rear	←→	
				Volvo	122	Amazon	62-71	Rear	←→	
G45078	Technomatic		† 5	Ford	Laser, Meteor, Tracer	Familia	69-76	Rear	←→	
				Ford	Ranchero	Falcon	69-76	Rear	←→	
				Mazda	1200, 1300	Familia (Mk II)	72-75	Rear	←→	
				Mazda	B Series, Drifter, Magnum	Mk II, II & IV	64-86	Rear	←→	
				Mazda	E2000, E2700, E3000	LDV	64-83	Rear	←→	
				Mazda	E2000, E3000	Truck	67-81	Rear	←→	
				Mazda	F1000, F1300	LDV	81-86	Rear	←→	
				Triumph	Chicane	2000, 2500	65-78	Rear	←→	
G45122	Technomatic		☉ 6,1	Alfa-Romeo	Other	Incl. Giulia	66-77	Front	←→	
				Nissan	E20 (Urvan, Caravan)	Ekonowagon, Ekonovan	73-81	Front	←→	
				Suzuki	SJ410/413, Samurai	4x4, S/W	82-87	Front	←→	
				Suzuki	SJ410/413, Samurai	4x4, S/W	87-90	Front	←→	
				Nissan	Y' Series	1200	72-75	Rear	←→	

PARTS LISTING

Shocks & Struts

G45138



Part #	Range	Superceding Part #/Status	Product Type	Make	Model	Derivative	Year	Position	L/R	Note # (pg 6)
G45138	Technomatic		6,1	Nissan	Caball	Truck	64-78	Front	↔	
				Nissan	Caball	Truck	78-84	Front	↔	
				Toyota	Stout	RK 101	61-89	Front	↔	
				Opel	Rekord	Caravan (E)	78-92	Rear	↔	
G45212	Technomatic		4	Mazda	B Series, Drifter, Magnum	Mk II, II & IV	64-86	Front	↔	
				Chevrolet	2500, 3800, 4100	2.5, 3.8, & 4.1 Estate	75-78	Front	↔	
				Chevrolet	2500, 3800, 4100	2.5, 3.8, & 4.1 Sedan	73-78	Front	↔	
				Opel	Rekord	C	67-73	Front	↔	
G45255	Technomatic		4	Chevrolet	El Camino	Incl. El Toro	71-72	Front	↔	
				Nissan	Laurel	2000, 2300, 2400 (C30)	68-72	Front	↔	
				Nissan	Laurel	240, 260, 300 (C130)	72-78	Front	↔	
				Opel	Constantia, Kommando	Brougham	69-72	Front	↔	
G45258	Technomatic		5	Peugeot	404	Saloon	60-78	Rear	↔	
				Peugeot	504	L, GR	76-85	Rear	↔	
				Rambler	Hornet & Sportabout	AMC	70-76	Rear	↔	
G45398	Technomatic		4	Toyota	Corona	T100 Series	74-80	Front	↔	
				Toyota	Corona	Mk II 2000	72-78	Front	↔	
				Toyota	Corona	T60, T70 Series (Mark II 1900)	69-73	Front	↔	
				Toyota	Corona	T40, T50 Series (Incl. 2000 GSL)	64-74	Front	↔	
				Toyota	Hilux	4x2	69-84	Front	↔	
				Volvo	144, 164	B20, B30	68-71	Front	↔	
				Volvo	144, 164	B20E, B30	72-74	Front	↔	
G45399	Technomatic		6,1	Chevrolet	2500, 3800, 4100	2.5, 3.8, & 4.1 Estate	75-78	Rear	↔	
				Chevrolet	Commodore	C	78-92	Rear	↔	
				Opel	2500, 3800, 4100	2.5, 3.8, & 4.1 Estate	75-78	Rear	↔	
				Opel	Commodore	C	78-92	Rear	↔	
				Toyota	Corolla	Imported Strut (E30, E40, E50, E60)	74-80	Rear	↔	
				Toyota	Corolla	Imported Strut (E30, E40, E50, E60)	82-85	Rear	↔	
				Toyota	Corolla Carri	Imported Strut	73-79	Rear	↔	
				Toyota	Corolla Carri	Local Strut (E30, E40, E50, E60)	79-89	Rear	↔	
				Toyota	Corona	Mk II 2000	72-78	Rear	↔	
				Toyota	Corona	T40, T50 Series (Incl. 2000 GSL)	64-74	Rear	↔	
				Toyota	Cressida	X35, X36 (Imported Strut) (Mk I)	78-79	Rear	↔	
				Toyota	Cressida	X35, X36 (Local Strut) (Mk I)	79-81	Rear	↔	
G45413	Technomatic		8,5	Ford	Escort	Mk I	68-73	Rear	↔	
				Ford	Escort	Mk I 1100, 1300	70-75	Rear	↔	
				Ford	Escort	Mk I 1600, GT	70-75	Rear	↔	
				Ford	Escort	Mk I, II	74-81	Rear	↔	

G45138 - G45413



Part #	Range	Superceding Part#/Status	Product Type	Make	Model	Derivative	Year	Position	L/R	Note # (pg 6)
G45417	Technomatic		☉ 8,5	Volkswagen	1500, 1600	Type 3 car	63-69	Front	↔	
				Volkswagen	Kombi	Microbus (Double Jointed Axle Rear)	68-80	Front	↔	
G45418	Technomatic		☉ 8,2	Ford	Cortina	Mk III, IV	71-78	Rear	↔	20
				Volkswagen	Kombi	Microbus (Double Jointed Axle Rear)	68-80	Rear	↔	
G45419	Technomatic		☉ 8,5	Volkswagen	Beetle	Mk I	52-79	Front	↔	4
				Volkswagen	Kombi	Microbus, Fleetline (Swing Axle Rear)	55-78	Front	↔	
				Volkswagen	1500, 1600	Type 3 car	63-69	Rear	↔	
				Volkswagen	Beetle	Mk I	52-79	Rear	↔	4
				Volkswagen	Kombi	Microbus, Fleetline (Swing Axle Rear)	55-78	Rear	↔	
G45423	Technomatic		☽ 6,1	Fiat	125	Sedan	69-75	Rear	↔	
				Ford	Taurus	17M, 20M	61-73	Rear	↔	19
				Nissan	Laurel	2000, 2300, 2400 (C30)	68-72	Rear	↔	
				Nissan	U' Series	1600, 1800 (Incl. Coupe)	72-73	Rear	↔	
				Nissan	U' Series	160U, 180U	74-78	Rear	↔	
G45432	Technomatic		♀ 9,1	Nissan	1 Ton Bakkie	620, 680, 1300, 1500	66-80	Rear	↔	
				Nissan	Caball	Truck	78-84	Rear	↔	
				Nissan	E20 (Urvan, Caravan)	Ekonowagon, Ekonovan	73-81	Rear	↔	
				Nissan	E20 (Urvan, Caravan)	Ekonowagon, Ekonovan	81-95	Rear	↔	
G45447	Technomatic		☉ 8,5	Chevrolet	Nomad	LDV	75-78	Front	↔	
				Nissan	Vanette	C22	85-85	Front	↔	6
				Opel	Firenza	Coupe	71-78	Front	↔	
G45450	Technomatic		☽ 6,2	Peugeot	505	Saloon	80-85	Rear	↔	
G45466	Technomatic		⊕ 4	Chevrolet	Chevelle	Mk I	64-70	Front	↔	
				Ford	Husky	LDV, P-Van	86-93	Front	↔	
				Mitsubishi	L300 (Delica)	Incl. Starwagon, Express	82-03	Front	↔	
				Toyota	Condor	4x2 Mk IV	00-05	Front	↔	
				Toyota	Hiace	H10	69-84	Front	↔	
G45469	Technomatic		☽ 6,1	Toyota	Cressida	MX63 (Mk II)	81-93	Rear	↔	
G45470	Technomatic		☉ 8,5	Peugeot	404	Estate	69-78	Rear	↔	
				Peugeot	504	Estate	74-85	Rear	↔	
				Peugeot	504	GL, GLD, Ti	73-80	Rear	↔	
G45489	Technomatic		☽ 6,2	Opel	2500, 3800, 4100	2.5, 3.8, & 4.1 Sedan	73-78	Rear	↔	
				Chevrolet/Opel	Ascona, Chevailr	B, (Mk I Cavalier)	76-82	Rear	↔	
				Opel	Commodore	C	78-88	Rear	↔	
				Opel	Rekord	Sedan (Excl. V6) (E)	78-97	Rear	↔	
G45503	Technomatic		☽ 10	Ford	Cortina	Mk III	71-77	Front	↔	
				Ford	Cortina	Mk IV	77-80	Front	↔	
				Ford	Granada	Mk I, Mk II	72-86	Front	↔	

PARTS LISTING

Shocks & Struts

G45520



G45520 – G45812

Part #	Range	Superceding Part #/Status	Product Type	Make	Model	Derivative	Year	Position	L/R	Note # (pg 6)
G45520	Technomatic		8,5	Ford	Cortina	Mk III	71-77	Rear	↔	
				Ford	Cortina	Mk IV	77-80	Rear	↔	
				Ford	Cortina	Mk V	80-83	Rear	↔	
G45523	Technomatic		4	Mazda	F1000, F1300	LDV	81-86	Front	↔	
G45532	Technomatic		4	BMW	2 Series	1802, 2002 (E10)	68-75	Front	↔	
				Chevrolet	El Camino	Incl. El Toro	72-78	Front	↔	
				Opel	Constantia, Kommando	Incl. Caprice, De Ville (AQ)	72-79	Front	↔	
G45533	Technomatic		6,1	Nissan	Y' Series	140Y, 160Y	75-80	Rear	↔	
				Opel	Constantia, Kommando	Brougham	69-72	Rear	↔	
				Opel	Constantia, Kommando	Incl. Caprice, De Ville (AQ)	72-79	Rear	↔	
				Opel	Firenza	Coupe	71-78	Rear	↔	2
				Opel	Kadett	B	66-74	Rear	↔	
				Opel	Rekord	C	67-73	Rear	↔	
				Chevrolet	El Camino	Incl. El Toro	71-72	Rear	↔	
G45534	Technomatic		8,4	Chevrolet	El Camino	Incl. El Toro	72-78	Rear	↔	
G45535	Technomatic		6,2	Chevrolet	LUV	Faster	73-78	Front	↔	
				Hyundai	H100	Bakkie	96-05	Front	↔	
				Isuzu	KB (D-Max), TF Series	(Mk I)	78-80	Front	↔	
				Isuzu	KB (D-Max), TF Series	4x4 (Mk II)	80-88	Front	↔	
				Jaguar	Jaguar	Mk II	61-69	Front	↔	1
				Jaguar	Jaguar	Mk X, 420, 420G, S Type (4 shocks at Rear)	65-72	Front	↔	1
				Nissan	E20 (Urvan, Caravan)	Ekonowagon, Ekonovan	81-95	Front	↔	
				Toyota	Condor	4x4 Mk IV	00-05	Front	↔	
G45651	Technomatic		4	Ford	Granada	Mk I, Mk II	72-86	Rear	↔	
G45666	Technomatic		4	Alfa-Romeo	Alfetta, Giulietta, Super, 159i	Incl. GT, GTV	73-86	Front	↔	
G45667	Technomatic		5	Mazda	E2000, E2700, E3000	LDV	64-83	Front	↔	
				Mazda	E2000, E3000	Truck	67-81	Front	↔	
				Alfa-Romeo	Alfetta, Giulietta, Super, 159i	Incl. GT, GTV	73-86	Rear	↔	
G45715	Technomatic		8,5	Audi	80	B1	75-81	Rear	↔	
				Volkswagen	Passat	B1	74-81	Rear	↔	
G45742	Technomatic		6,2	Ford	Escort	Mk II	75-81	Rear	↔	
G45810	Technomatic		8,4	Fiat	132	Super Mirafiori	79-81	Rear	↔	
				Mazda	323	RWD (Imported Strut)	77-78	Rear	↔	
				Mazda	323	RWD (Local Strut)	78-81	Rear	↔	
G45812	Technomatic		8,4	Mitsubishi	Colt	Galant (Imported Strut)	77-78	Rear	↔	
				Mitsubishi	Colt	Galant (Local Strut)	78-83	Rear	↔	



Part #	Range	Superceding Part #/Status	Product Type	Make	Model	Derivative	Year	Position	L/R	Note # (pg 6)	
G45813	Technomatic		1/2	6,1	Toyota	Cressida	Non IRS+, MX63 (Mk II)	81-93	Rear	←→	
					Toyota	Cressida	X30, X32 (Imported Strut) (Mk I)	77-79	Rear	←→	
					Toyota	Cressida	X30, X32 (Local Strut) (Mk I)	79-81	Rear	←→	
G45824	Technomatic		3/8	8,5	Mitsubishi	Tredia	Excl. Turbo	83-86	Rear	←→	
					Mitsubishi	Tredia	Turbo	83-86	Rear	←→	
G45837	Technomatic		1	10	Ford	Cortina	Mk V	80-83	Front	←→	
					Ford	Cortina	Mk V	80-83	Front	←→	
G45838	Technomatic		1/2	6,2	Ford	Cortina	Mk V	80-83	Rear	←→	14
G45839	Technomatic		1/2	6,2	Chevrolet/Opel	Ascona, Chevailr	Incl. Coupe (C)	82-85	Rear	←→	
					Chevrolet/Opel	Ascona, Chevailr	Incl. Coupe (short Strut) (C)	84-86	Rear	←→	
					Opel	Kadett	D	80-85	Rear	←→	
					Opel	Kadett	T-Car (E)	85-89	Rear	←→	
					Opel	Monza	Incl. GSi	86-89	Rear	←→	
G45841	Technomatic		1/2	6,1	Toyota	Corolla	RWD (Excl. Van, S/W) (E70)	80-85	Rear	←→	
					Toyota	Corona	T100 Series	74-80	Rear	←→	
G45842	Technomatic		1/2	6,2	Nissan	1 Ton Bakkie	620, 680, 1300, 1500	66-80	Front	←→	
					Nissan	1 Ton Bakkie	720 4x2	80-88	Front	←→	
					Nissan	1 Ton Bakkie	Hardbody 4x4 (Incl. Sani, Patrol) (D21)	88-02	Front	←→	
					Nissan	Sani	4x4	90-99	Front	←→	
					Nissan	Tracker	4x4	80-82	Front	←→	
					Nissan	Tracker	4x4 (Incl. Sani)	82-88	Front	←→	
G45844	Technomatic		1/2	6,2	Isuzu	KB (D-Max), TF Series	4x2 (Mk II)	80-88	Front	←→	
					Isuzu	KB (D-Max), TF Series	4x2 (Standard Height) (TF)	89-04	Front	←→	
G45858	Technomatic		1	4	Ford	Sierra, Sapphire	Estate	83-93	Rear	←→	
G45859	Technomatic		1/2	6,2	Nissan	Langley, Pulsar	Incl. Exa (Sealed Strut) (N12)	83-88	Rear	←→	
G45860	Technomatic		3/8	8,5	Ford	Sierra, Sapphire	2300, 2000, 1600	83-93	Rear	←→	
					Ford	Sierra, Sapphire	3000 (Incl. XR6)	83-93	Rear	←→	
G45861	Technomatic		1/2	6,2	BMW	2 Series	1802, 2002 (E10)	68-75	Rear	←→	
					Daihatsu	Charade	Incl. Coupe (G11)	83-87	Rear	←→	
G45862	Technomatic		1	4	GWM	GWM	2.2, 2.8TDi (4x2)	07 on	Front	←→	
					Toyota	Hilux	4x2	84-98	Front	←→	
					Toyota	Hilux	4x2 Standard Susp.	99-05	Front	←→	
G45869	Technomatic		1/2	6,2	Nissan	1 Ton Bakkie	Hardbody 4x2 (Excl. Hi Rider) (D21)	88-02	Front	←→	
					Nissan	1 Ton Bakkie	Hardbody 4x2 (Excl. Hi Rider) (D22)	02 on	Front	←→	
					Nissan	NP300	4x2 (Excl. Hi Rider) (D22)	08 on	Front	←→	
					Toyota	Hiace	LWB (H20, H30, H40)	84-93	Front	←→	
					Toyota	Hiace	SWB (H20, H30, H40)	84-88	Front	←→	
					Toyota	Hiace	SWB (H50)	88-93	Front	←→	

PARTS LISTING

Shocks & Struts

G45870



Part #	Range	Superceding Part #/Status	Product Type	Make	Model	Derivative	Year	Position	L/R	Note # (pg 6)
G45870	Technomatic		8,2	Ford	Spectron	Minibus, Van	91-03	Rear	↔	
				GWM	GWM	2.2, 2.8TDi (4x2)	07 on	Rear	↔	
				Isuzu	KB (D-Max), TF Series	4x2 (Mk II)	80-88	Rear	↔	
				Isuzu	KB (D-Max), TF Series	4x4 (Mk II)	80-88	Rear	↔	
				Mazda	Marathon (Ford Husky)	Van, Bus	91-03	Rear	↔	
				Nissan	Tracker	4x4 (Incl. Sani)	82-88	Rear	↔	
				Toyota	Hilux	4x2	84-98	Rear	↔	
G45871	Technomatic		6,2	Ford	Courier	4x2 Standard Susp.	86-06	Front	↔	
				Ford	Ranger	4x2 Standard Susp.	86-06	Front	↔	
				Isuzu	KB (D-Max), TF Series	4x4, 4x2 (Raised Height) (TF)	89-04	Front	↔	
				Mazda	B Series, Drifter, Magnum	4x2 Standard Susp.	86-06	Front	↔	
G45872	Technomatic		8,2	Ford	Courier	4x2 Standard Susp.	86-06	Rear	↔	
				Ford	Ranger	4x2 Standard Susp.	86-06	Rear	↔	
				Mazda	B Series, Drifter, Magnum	4x2 Standard Susp.	86-06	Rear	↔	
				Mitsubishi	Colt Bakkie	L200 (4x2 Standard Height)	98-07	Rear	↔	
				Nissan	1 Ton Bakkie	Hardbody 4x2 (Excl. Hi Rider) (D21)	88-02	Rear	↔	
				Nissan	1 Ton Bakkie	Hardbody 4x2 Hi Rider (D21)	88-02	Rear	↔	
				Nissan	1 Ton Bakkie	Hardbody 4x4 (Incl. Sani, Patrol) (D21)	88-02	Rear	↔	
				Nissan	Sani	4x2	90-99	Rear	↔	
				Nissan	Sani	4x4	90-99	Rear	↔	
				Toyota	Condor	4x2 Mk IV	00-05	Rear	↔	
G45873	Technomatic		8,2	Toyota	Hiace	LWB (H20, H30, H40)	84-93	Rear	↔	
				Toyota	Hiace	SWB (H50)	88-93	Rear	↔	
G45874	Technomatic		6,2	Daewoo	Cielo	Nexia	95-98	Rear	↔	14
				Daewoo	Espero	Aranos	95-98	Rear	↔	14
				Daewoo	Lanos	Sens	97-03	Rear	↔	14
				Opel	Astra	F	93-99	Rear	↔	14
				Opel	Kadett	Astra	93-99	Rear	↔	14
				Opel	Kadett	T-Car (E)	89-93	Rear	↔	14
				Opel	Monza	Incl. Cub	89-93	Rear	↔	14
G45875	Technomatic		8,5	Ford	Bantam	1300, 1600	83-86	Rear	↔	
				Ford	Bantam	1400, 1600	86-94	Rear	↔	
				Mazda	Rustler	130, 160	85-86	Rear	↔	
				Mazda	Rustler	1400, 1600	86-94	Rear	↔	
G45876	Technomatic		4	Ford	Spectron	Minibus, Van	91-03	Front	↔	
				Mazda	Marathon (Ford Husky)	Van, Bus	91-03	Front	↔	
G45877	Technomatic		8,5	Volkswagen	Golf	Incl. Sport (Typ 14)	81-93	Rear	↔	
				Volkswagen	Golf	Pickup	93-03	Rear	↔	

G45870 - G45877



Part #	Range	Superceding Part#/Status	Product Type	Make	Model	Derivative	Year	Position	L/R	Note # (pg 6)
G45878	Technomatic		☉ 8,5	Ford	Bantam	1.3, 1.6	03-06	Rear	←→	
				Ford	Bantam	1.3, 1.6 (Mk III)	06 on	Rear	←→	
				Ford	Bantam	1.3, 1.6, 1.8D	02	Rear	←→	
				Ford	Bantam	1300, 1600	94-02	Rear	←→	
				Mazda	Rustler	1300, 1600	94-02	Rear	←→	
G45879	Technomatic		☉ 6,2	Volkswagen	Polo	Mk V (Typ 6R) (Excl. GTi)	10 on	Rear	←→	
				Volkswagen	Polo	Mk IV	02-09	Rear	←→	
				Volkswagen	Polo	Vivo (Mk IV)	10 on	Rear	←→	
G45881	Technomatic		☉ 8,5	Opel	Astra	Excl. 2.0 OPC (G)	99-03	Rear	←→	
				Opel	Astra	Excl. 2.0 OPC (G)	99-03	Rear	←→	
G45885	Technomatic		☉ 6,2	Mahindra	Scorpio	4x4	05 on	Front	←→	
G45886	Technomatic		☉ 8,4	Mahindra	Scorpio	4x2	05 on	Rear	←→	
				Mahindra	Scorpio	4x4	05 on	Rear	←→	
G45888	Technomatic		☿ 3,2	Toyota	Hilux	4x2 Standard Susp.	05-16	Front	L	
G45889	Technomatic		☿ 3,2	Toyota	Hilux	4x2 Standard Susp.	05-16	Front	R	
G45890	Technomatic		☉ 6,2	Toyota	Yaris	T1 1.0L, T3 1.3L (Mk II)	05-11	Rear	←→	
				Toyota	Yaris	T3 1.3L (Mk II)	06-11	Rear	←→	
G45891	Technomatic		☉ 8,5	Toyota	Avanza	1.3 & 1.5 (Xenia)	06 on	Rear	←→	
G45892	Technomatic		☉ 6,2	Mazda	Mazda 3	1.6, 2.0 Excl. MPS (Mk I)	04-09	Rear	←→	
G45893	Technomatic		☉ 6,2	Isuzu	KB (D-Max), TF Series	4x2 (Mk II)	80-88	Front	←→	
				Isuzu	KB (D-Max), TF Series	4x2 (Standard Height) (TF)	89-04	Front	←→	
				Lada	Niva	VAZ-2121	87-92	Front	←→	16
				Mitsubishi	Colt Bakkie	L200 (4x2 Raised Height)	98-07	Front	←→	
				Nissan	1 Ton Bakkie	Hardbody 4x2 (Excl. Hi Rider) (D21)	88-02	Front	←→	
				Nissan	1 Ton Bakkie	Hardbody 4x2 (Excl. Hi Rider) (D22)	02 on	Front	←→	
				Nissan	1 Ton Bakkie	Hardbody 4x2 Hi Rider (D21)	88-02	Front	←→	
				Nissan	1 Ton Bakkie	Hardbody 4x2 Hi Rider (D22)	02 on	Front	←→	
				Nissan	NP300	4x2 (Excl. Hi Rider) (D22)	08 on	Front	←→	
				Nissan	NP300	4x2 Hi Rider (D22)	08 on	Front	←→	
				Toyota	Hiace	LWB (H20, H30, H40)	84-93	Front	←→	
				Toyota	Hiace	SWB (H20, H30, H40)	84-88	Front	←→	
				Toyota	Hiace	SWB (H50)	88-93	Front	←→	
G45894	Technomatic		☉ 6,2	Ford	Focus	Mk II Hatch & Sedan (Excl. STi)	04-11	Rear	←→	
G45896	Technomatic		☉ 8,5	Chana	Star	Bakkie, P-Van, Minibus (Incl. Maxi Star)	06 on	Rear	←→	
G45897	Technomatic		☉ 6,2	Chevrolet	Spark	M300 (Excl. Lite)	10 on	Rear	←→	
G45898	Technomatic		☿ 3,2	Kia	Sorento	2.5D, 3.5 & 3.8 (Mk I)	02-09	Front	L	
G45899	Technomatic		☿ 3,2	Kia	Sorento	2.5D, 3.5 & 3.8 (Mk I)	02-09	Front	R	
G45900	Technomatic		☉ 6,2	Volkswagen	Golf IV	Estate	99-06	Rear	←→	
G45901	Technomatic		☉ 6,2	Suzuki	Jimny	Gen 3 - SN413/JA/JB33	98 on	Front	←→	

PARTS LISTING

Shocks & Struts

G45902



Part #	Range	Superceding Part #/Status	Product Type	Make	Model	Derivative	Year	Position	L/R	Note # (pg 6)
G45902	Technomatic		⊘ 8.5	Suzuki	Jimny	Gen 3 - SN413/JA/JB33	98 on	Rear	↔	
G45904	Technomatic		# 3.2	GWM	Steed	Pick-Up 4x2	08 on	Front	↔	
G45905	Technomatic		⊘ 8.2	GWM	Steed	Pick-Up 4x2	08 on	Rear	↔	
G51023	Gas Ryder		# 3,2	Audi	A4	1.8, 2.4, 2.6, 2.8 Excl. Quattro (B5)	94-01	Rear	↔	
G51059	Gas Ryder		# 3,2	Hyundai	Elantra	J1 Series (Avante)	94-96	Rear	↔	
G51082	Gas Ryder		# 3,2	Ford	Escort	Mk V	95-99	Rear	↔	
G51089	Gas Ryder	69082	# 3,3	Mazda	Soho	121 (Bracket)	97-99	Rear	↔	
G51101	Gas Ryder		# 3,3	Audi	A6	Excl. & Quattro (C5)	97-04	Front	↔	
				Audi	A6	Quattro (C5)	97-04	Front	↔	
G51186	Gas Ryder		# 3,2	Hyundai	Sonata	Y3	95-98	Rear	↔	
G51213	Gas Ryder		# 3,2	Nissan	Primera	P11-144	98-02	Front	↔	
G51214	Gas Ryder		# 3,2	Nissan	Primera	P11-144	98-02	Rear	↔	
G51216	Gas Ryder		# 3,2	BMW	5 Series	E39 Series (520i, 523i, 525i, 525TDS, 528i, 530i, 530D) (Excl.)	96-04	Rear	↔	
				BMW	5 Series	E39 Series (535i, 540i) (Excl.)	96-04	Rear	↔	
G51217	Gas Ryder		# 3,1	Alfa-Romeo	156	2.0 Twin Spark (932) (Excl.) (→VETO116245)	97-98	Front	↔	
				Alfa-Romeo	156	2.0 Twin Spark (932) (Excl.) (VETO116246→)	98-06	Front	↔	
G51231	Gas Ryder		# 3,1	Alfa-Romeo	147	1.6 (937), 2.0	01 on	Front	↔	
				Alfa-Romeo	156	2.5 V6 (932) Y (→VETO116245)	97-98	Front	↔	
				Alfa-Romeo	156	2.5 V6 (932) Y (VETO116246→)	98-06	Front	↔	
G51235	Gas Ryder	69095	# 3,2	Ford	Fiesta	Mark IV (Excl. 1.6 Rsi 3-door) (Sleeve eye)	99-03	Rear	↔	22
				Ford	Ikona	B3 (Sleeve eye)	00-06	Rear	↔	22
				Mazda	Soho	121 (Eye)	97-99	Rear	↔	22
G51255	Gas Ryder		# 3,1	Honda	CR-V	RD1-RD3	95-01	Front	↔	
G51256	Gas Ryder		# 3,2	Honda	CR-V	RD1-RD3	95-01	Rear	↔	
G51269	Gas Ryder		# 3,2	Volvo	S40	Excl. , & T4 Rear (Mk I)	95-04	Rear	↔	
G51275	Gas Ryder		# 3,2	Ford	KA	1.3 (Mk I)	05-08	Rear	↔	
G51298	Gas Ryder		# 3,2	Honda	Civic	Mk VII	01-05	Rear	↔	
G54023	Gas Ryder		# 1,1	Kia	Rio	Rio 1.4 & 1.6 Gen2 (JB)	06-11	Front	L	
				Hyundai	Accent	MC. 1.6	05-11	Front	L	
G54024	Gas Ryder		# 1,1	Kia	Rio	Rio 1.4 & 1.6 Gen2 (JB)	06-11	Front	R	
				Hyundai	Accent	MC. 1.6	05-11	Front	R	
G55592	Gas Ryder		# 1,1	Hyundai	Elantra	J1 Series (Avante)	94-96	Front	↔	
G55600	Gas Ryder		# 1,1	Mazda	626	Zimbabwe model	87-91	Front	↔	
G55601	Gas Ryder		# 1,1	Mazda	626	Zimbabwe model	87-91	Rear	↔	
G55613	Gas Ryder	G56518	# 1,1	Suzuki	Vitara	5-door (Excl. V6) (Mk I)	94-98	Front	↔	
G55614	Gas Ryder	G56518	# 1,1	Suzuki	Vitara	5-door (Excl. V6) (Mk I)	94-98	Front	↔	
G55673	Gas Ryder		# 1,1	Hyundai	Sonata	Y3	95-98	Front	↔	

G45902 - G55673



G55697

PARTS LISTING

Shocks & Struts

G55697 – G56105

Part #	Range	Superceding Part #/Status	Product Type	Make	Model	Derivative	Year	Position	L/R	Note # (pg 6)
G55697	Gas Ryder		1,1	Chrysler	Voyager	Gen III (Incl. Grande Voyager) (Excl. )	96-00	Front	↔	
G55723	Gas Ryder		1,1	Honda	Prelude	Coupe	83-87	Front	↔	
				Honda	Prelude	Coupe (Sealed Struts Rear)	83-87	Front	↔	
G55821	Gas Ryder		1,1	Honda	Odyssey	RA1-RA5	97-99	Rear	↔	
G55877	Gas Ryder		1,1	Honda	Odyssey	RA1-RA5	97-99	Front	↔	
G55910	Gas Ryder		1,1	Honda	Ballade	150i, 160i, 180i Excl. Vtech (Mk VI) (Civic)	96-01	Rear	↔	
				Honda	Civic	Mk VI	96-01	Rear	↔	
G56102	Safari		8,2	Jeep (Chrysler)	Jeep	CJ Series (Willys) (CJ5, CJ6, CJ7)	54-86	Front	↔	
				Leyland	FG 550, FG 420	Truck	68-77	Front	↔	
				Toyota	Dyna	Coaster	66-77	Front	↔	
				Bedford	CF Series	Van, Truck	70-84	Rear	↔	
				Ford	F Series	F100, F250 4x2	65-67	Rear	↔	
				Ford	F Series	F100, F250 4x2	68-69	Rear	↔	
				Ford	F Series	F350	67-81	Rear	↔	
				Ford	Husky	LDV, P-Van	86-93	Rear	↔	
				Ford	Triton 0510, 0610	Truck	85-87	Rear	↔	
				Hyundai	H100	Bakkie	96-05	Rear	↔	
				Lada	Niva	2121	87-92	Rear	↔	16
				Mitsubishi	Canter	Truck	80 on	Rear	↔	
				Mitsubishi	L300 (Delica)	Incl. Starwagon, Express	82-03	Rear	↔	
				Nissan	1 Ton Bakkie	720 4x2	80-88	Rear	↔	
				Nissan	Caball	Truck	64-78	Rear	↔	
				Toyota	Dyna	All	94 on	Rear	↔	
				Toyota	Dyna	Coaster	78-95	Rear	↔	
				Toyota	Hiace	H10	69-84	Rear	↔	
				Toyota	Stallion	KF40	87-00	Rear	↔	
				Toyota	Venture	KF40	91-00	Rear	↔	
G56103	Safari		8,2	Ford	Cortina	Mk III, IV	71-78	Rear	↔	20
				Isuzu	KB (D-Max), TF Series	4x2 (Standard Height) (TF)	89-04	Rear	↔	
				Isuzu	KB (D-Max), TF Series	4x4, 4x2 (Raised Height) (TF)	89-04	Rear	↔	
				Kia	K2700	Bongo (Gen 3)	00-04	Rear	↔	
				Toyota	Hilux	4x4	79-84	Rear	↔	
G56105	Safari		5	Nissan	Patrol	S/W 4x4 (Y60, Y61, Rear for Y60 only)	89-01	Front	↔	
				Ford	Ranchero	Falcon	69-76	Rear	↔	
				Mazda	B Series, Drifter, Magnum	Mk II, II & IV	64-86	Rear	↔	
				Mazda	E2000, E2700, E3000	LDV	64-83	Rear	↔	
G56105	Safari		5	Mazda	E2000, E3000	Truck	67-81	Rear	↔	
				Mazda	F1000, F1300	LDV	81-86	Rear	↔	

Be safe. Be sure

PARTS LISTING

Shocks & Struts

G56106



Part #	Range	Superceding Part #/Status	Product Type	Make	Model	Derivative	Year	Position	L/R	Note # (pg 6)
G56106	Safari		8,1	Chevrolet	C Series	C10, C20	63-73	Front	↔	
				Chevrolet	C Series	C10, C20	74-83	Front	↔	
				Chevrolet	C Series	C30	63-73	Front	↔	
				Chevrolet	C Series	C30	74-83	Front	↔	
G56107	Safari		8,5	Chevrolet	C Series	C10, C20	63-73	Rear	↔	
G56112	Safari		8,2	Land Rover	Defender	109 WB, Series I	54-65	Front	↔	
				Land Rover	Defender	109 WB, Series II, III	65-84	Front	↔	
				Land Rover	Defender	88 WB	54-80	Front	↔	
G56113	Safari		9,1	Land Rover	Defender	109 WB, Series II, III	65-84	Rear	↔	
G56116	Safari		8,2	Bedford	J2-4	Truck	65 on	Rear	↔	
				Chevrolet	LUV	Faster	73-78	Rear	↔	
				Jeep (Chrysler)	Jeep	CJ Series (Willys) (CJ5, CJ6, CJ7)	54-86	Rear	↔	
				Ford	Courier	4x2 Standard Susp.	86-06	Rear	↔	
				Ford	Ranger	4x2 Standard Susp.	86-06	Rear	↔	
				Isuzu	KB (D-Max), TF Series	(Mk I)	78-80	Rear	↔	
				Mazda	B Series, Drifter, Magnum	4x2 Standard Susp.	86-06	Rear	↔	
				Mitsubishi	Colt Bakkie	L200 (1.6, 2.0, 2.5D 4x2)	94-98	Rear	↔	
				Mitsubishi	Colt Bakkie	L200 (4x2 Standard Height)	98-07	Rear	↔	
				Nissan	1 Ton Bakkie	Hardbody 4x2 (Excl. Hi Rider) (D21)	88-02	Rear	↔	
				Nissan	1 Ton Bakkie	Hardbody 4x2 Hi Rider (D21)	88-02	Rear	↔	
				Nissan	1 Ton Bakkie	Hardbody 4x4 (Incl. Sani, Patrol) (D21)	88-02	Rear	↔	
				Nissan	Sani	4x2	90-99	Rear	↔	
				Nissan	Sani	4x4	90-99	Rear	↔	
				Toyota	Dyna	Coaster	66-77	Rear	↔	
Toyota	Stout	RK 101	61-89	Rear	↔					
G56118	Safari		6,2	Mitsubishi	FK Series	FK 115J/K	80-86	Front	↔	
				Mitsubishi	FM Series	FM215F/L	79-86	Front	↔	
				Chevrolet	El Camino	Incl. El Toro	71-72	Rear	↔	
				Ford	F Series	F100, F250 4x2	70-81	Rear	↔	5
G56119	Safari		5	Bedford	J2-4	Truck	65 on	Front	↔	
				Bedford	J5-6	Truck	65 on	Front	↔	
				Ford	F Series	F100, F250 4x2	65-67	Front	↔	
				Nissan	Patrol	4x4 (G160)	80-89	Front	↔	
				Nissan	Patrol	4x4 (WG60)	72-80	Front	↔	
				Nissan	Safari	S/W (G160/G161) & Pickup	82-90	Front	↔	
				Volvo	122	Amazon, B18	59-71	Front	↔	
				Jaguar	Jaguar	Mk II	61-69	Rear	↔	
				Nissan	Patrol	4x4 (WG60)	72-80	Rear	↔	

G56106 – G56119



Part #	Range	Superceding Part #/Status	Product Type	Make	Model	Derivative	Year	Position	L/R	Note # (pg 6)
G56120	Safari	G45667	† 5	Ford	F Series	F250 4x4	68-77	Front	←→	
				Mazda	E2000, E2700, E3000	LDV	64-83	Front	←→	
				Mazda	E2000, E3000	Truck	67-81	Front	←→	
G56123	Safari		⊕ 6,2	Ford	F Series	F100, F250 4x2	68-69	Front	←→	
				Ford	F Series	F100, F250 4x2	70-81	Front	←→	5
				Ford	F Series	F350	67-81	Front	←→	
G56126	Safari		⊙ 8,2	Bedford	KE, KG, KH All	Truck	64 on	Front	←→	29
				Bedford	MFR	Truck	67-71	Front	←→	29
				Bedford	VAL	Bus	66 on	Front	←→	
				Bedford	J5-6	Truck	65 on	Rear	←→	29
				Bedford	KE, KG, KH All	Truck	64 on	Rear	←→	29
				Bedford	MFR	Truck	67-71	Rear	←→	29
				Chevrolet	C Series	C30	63-73	Rear	←→	
				Isuzu	N2800 P	Truck	93 on	Rear	←→	
				Isuzu	N3000 P	Truck	87-90	Rear	←→	
				Isuzu	NKR55/99	Truck	19...	Rear	←→	
				Isuzu	TL40-50	Truck	75 on	Rear	←→	
				Isuzu	TLD44, TLD54	Truck	77-89	Rear	←→	
				Land Rover	Defender	109 WB, Series I	54-65	Rear	←→	
Land Rover	Defender	88 WB	54-80	Rear	←→					
G56153	Safari		≡ 10	Ford	Cortina	Mk III, IV	71-78	Front	←→	
				Ford	Cortina	Mk IV	78-80	Front	←→	
G56155	Safari		⊕ 6,2	Ford	F Series	F250 4x4	78-81	Rear	←→	
G56156	Safari		♀ 9,2	Ford	Cortina	Mk IV	78-80	Rear	←→	
				Ford	Cortina	Mk V	80-82	Rear	←→	
G56157	Safari		♀ 9,1	Nissan	1 Ton Bakkie	620, 680, 1300, 1500	66-80	Rear	←→	
				Nissan	Caball	Truck	78-84	Rear	←→	
				Nissan	E20 (Urvan, Caravan)	Ekonowagon, Ekonovan	73-81	Rear	←→	
				Nissan	E20 (Urvan, Caravan)	Ekonowagon, Ekonovan	81-95	Rear	←→	
G56158	Safari		⊕ 6,2	Toyota	Hilux	4x4	79-84	Front	←→	
				Toyota	Hilux	4x4	84-98	Front	←→	
G56159	Safari		♀ 9,2	Ford	Cortina	Mk V	83-86	Rear	←→	
G56160	Safari		≡ 10	Ford	Cortina	Mk V	80-82	Front	←→	
				Ford	Cortina	Mk V	83-86	Front	←→	
G56161	Safari		⊙ 8,5	Volkswagen	Kombi	Microbus (Excl. Synchro 4x4)	80-02	Rear	←→	
G56162	Safari		⊙ 8,2	Land Rover	Defender	109, 110 WB Forward Control	65-83	Front	←→	
				Nissan	Caball	Truck	96 on	Rear	←→	
				Nissan	Cabstar 20, 35, 40	Truck	96 on	Rear	←→	
G56163	Safari		♀ 9,1	Land Rover	Defender	109, 110 WB Forward Control	65-83	Rear	←→	

PARTS LISTING

Shocks & Struts

G56164



Part #	Range	Superceding Part #/Status	Product Type	Make	Model	Derivative	Year	Position	L/R	Note # (pg 6)
G56164	Safari		† 5	Land Rover	Defender	90, 110, 130 (Incl. County & LDV)	84 on	Front	↔	
				Land Rover	Discovery	Series I	89-98	Front	↔	
				Land Rover	Range Rover	Excl. Air Susp. (Mk I)	70-96	Front	↔	
G56165	Safari		♀ 9,1	Land Rover	Defender	90, 110, 130 (Incl. County & LDV)	84 on	Rear	↔	
				Land Rover	Discovery	Series I	89-98	Rear	↔	
				Land Rover	Range Rover	Excl. Air Susp. (Mk I)	70-96	Rear	↔	
				Land Rover	Range Rover	Air Susp. (Mk I)	92-96	Rear	↔	
G56166	Safari		♂ 6,1	Isuzu	JCR 360, FTR	Truck	79-86	Front	↔	
				Nissan	Cabstar	Truck	84-90	Front	↔	
				Toyota	Landcruiser	FJ62, BJ60 S/W	83-89	Front	↔	
G56167	Safari		♀ 8,2	Toyota	Hilux	4x4	84-98	Rear	↔	
				Toyota	Landcruiser	HZJ70	89-99	Rear	↔	
				Toyota	Hilux	4x4, 4x2 Raised Susp.	99-05	Rear	L	
G56168	Safari		♀ 9,1	Nissan	Safari	S/W (G160/G161)	82-90	Rear	↔	
				Nissan	Tracker	4x4	80-82	Rear	↔	
G56169	Safari		♂ 6,2	Ford	Courier	4x4, 4x2 Hi-Trail (Raised Susp.)	86-06	Front	↔	
				Ford	Ranger	4x4, 4x2 Hi-Trail (Raised Susp.)	86-06	Front	↔	
				Mazda	B Series, Drifter, Magnum	4x4, 4x2 Hi-Trail (Raised Susp.)	86-06	Front	↔	
				Tata	Telcoline	4x4, 4x2	04 on	Front	↔	
G56170	Safari		♀ 8,5	Ford	Courier	4x4, 4x2 Hi-Trail (Raised Susp.)	86-06	Rear	↔	
				Ford	Ranger	4x4, 4x2 Hi-Trail (Raised Susp.)	86-06	Rear	↔	
				Mazda	B Series, Drifter, Magnum	4x4, 4x2 Hi-Trail (Raised Susp.)	86-06	Rear	↔	
G56171	Safari		♂ 6,2	Nissan	1 Ton Bakkie	620, 680, 1300, 1500	66-80	Front	↔	
				Nissan	1 Ton Bakkie	720 4x2	80-88	Front	↔	
				Nissan	1 Ton Bakkie	Hardbody 4x2 Hi Rider (D21)	88-02	Front	↔	
				Nissan	1 Ton Bakkie	Hardbody 4x2 Hi Rider (D22)	02 on	Front	↔	
				Nissan	1 Ton Bakkie	Hardbody 4x4 (D22)	98 on	Front	↔	
				Nissan	1 Ton Bakkie	Hardbody 4x4 (Incl. Sani, Patrol) (D21)	88-02	Front	↔	
				Nissan	NP300	4x2 Hi Rider (D22)	08 on	Front	↔	
				Nissan	NP300	4x4 (D22)	08 on	Front	↔	
				Nissan	Sani	4x4	90-99	Front	↔	
				Nissan	Tracker	4x4	80-82	Front	↔	
				Nissan	Tracker	4x4 (Incl. Sani)	82-88	Front	↔	
G56172	Safari		♂ 6,2	Mitsubishi	Colt Bakkie	L200 (4x2 Raised Height)	98-07	Front	↔	
				Mitsubishi	Colt Bakkie	L200 (4x4)	98-07	Front	↔	
				Nissan	Sani	4x2	90-99	Front	↔	
				Toyota	Hiace	LWB (H20, H30, H40)	84-93	Front	↔	
				Toyota	Hiace	SWB (H20, H30, H40)	84-88	Front	↔	
				Toyota	Hiace	SWB (H50)	88-93	Front	↔	

G56164 – G56172



Part #	Range	Superceding Part #/Status	Product Type	Make	Model	Derivative	Year	Position	L/R	Note # (pg 6)
G56173	Safari		6,2	Ford	Courier	4x2 Standard Susp.	86-06	Front	←→	
				Ford	Ranger	4x2 Standard Susp.	86-06	Front	←→	
				Isuzu	Frontier	4x4, 4x2	98-02	Front	←→	
				Isuzu	KB (D-Max), TF Series	4x4, 4x2 (Raised Height) (TF)	89-04	Front	←→	
				Isuzu	Trooper	Mk II	92-96	Front	←→	
				Mazda	B Series, Drifter, Magnum	4x2 Standard Susp.	86-06	Front	←→	
				Nissan	Terrano II	R20 LWB & SWB	99-04	Front	←→	
				Ssangyong	Musso	602TDi, E230EL, E320EL	95-06	Front	←→	
				Ssangyong	Musso Sport	DC Bakkie	04 on	Front	←→	
				Toyota	Hiace	Super T (H100)	93-10	Front	←→	
G56174	Safari		8,2	Bedford	MFR	Truck	72 on	Front	←→	
				Bedford	VAM	Bus	73-75	Front	←→	
				Bedford	MFR	Truck	72 on	Rear	←→	
				Bedford	VAM	Bus	73-75	Rear	←→	
				Nissan	Patrol	S/W 4x4 (Y60, Y61, Rear for Y60 only)	89-01	Rear	←→	
				Toyota	Landcruiser	DLX, BJ75	85-99	Rear	←→	
				Toyota	Hilux	4x4, 4x2 Raised Susp.	99-05	Rear	R	
G56175	Safari		8,2	Toyota	Hiace	LWB (H20, H30, H40)	84-93	Rear	←→	
				Toyota	Hiace	Super T (H100)	93-10	Rear	←→	
				Toyota	Hiace	SWB (H50)	88-93	Rear	←→	
G56176	Safari		6,2	Hyundai	H100	Bakkie	96-05	Front	←→	
				Isuzu	KB (D-Max), TF Series	(Mk I)	78-80	Front	←→	
				Isuzu	KB (D-Max), TF Series	4x4 (Mk II)	80-88	Front	←→	
				Isuzu	Trooper	Mk I	81-91	Front	←→	
				Nissan	E20 (Urvan, Caravan)	Ekonowagon, Ekonovan	81-95	Front	←→	
G56177	Safari		8,2	Toyota	Landcruiser	FJ45, BJ45	71-85	Front	←→	
				Mazda	T2000, 3000	LDV	83 on	Rear	←→	
				Mazda	T2000, T3000	Truck	81-86	Rear	←→	
				Toyota	Hiace	SWB (H20, H30, H40)	84-88	Rear	←→	
G56178	Safari		4	Kia	K2700	Bongo (Gen 3)	00-04	Front	←→	
				Kia	Pregio	Bongo	00-04	Front	←→	
				Toyota	Hilux	4x2	84-98	Front	←→	
				Toyota	Hilux	4x2 Standard Susp.	99-05	Front	←→	
G56179	Safari		6,1	Nissan	Caball	Truck	96 on	Front	←→	
				Toyota	Landcruiser	DLX, BJ75	85-99	Front	←→	
				Toyota	Landcruiser	HZJ70	89-99	Front	←→	
G56180	Safari		5	Land Rover	Range Rover	Air Susp. (Mk I)	92-96	Front	←→	

PARTS LISTING

Shocks & Struts

G56184



G56184 – G56212

Part #	Range	Superceding Part #/Status	Product Type	Make	Model	Derivative	Year	Position	L/R	Note # (pg 6)
G56184	Safari		☉ 8,2	Mitsubishi	Colt Bakkie	L200 (2.6, 3.0, V6 4x4, 4x2 Raised Height)	94-98	Rear	↔	
				Mitsubishi	Colt Bakkie	L200 (4x2 Raised Height)	98-07	Rear	↔	
				Mitsubishi	Colt Bakkie	L200 (4x4)	98-07	Rear	↔	
				Nissan	Terrano II	R50	99-04	Rear	↔	
G56185	Safari		⊥ 4	Ford	Husky	LDV, P-Van	86-93	Front	↔	
				Isuzu	WFR, Relay	Fargo	80-95	Front	↔	
				Mitsubishi	Colt Bakkie	L200 (2.6, 3.0, V6 4x4, 4x2 Raised Height)	94-98	Front	↔	
				Mitsubishi	L300 (Delica)	Incl. Starwagon, Express	82-03	Front	↔	
				Toyota	Stallion	KF40	87-00	Front	↔	
				Toyota	Venture	KF40	91-00	Front	↔	
G56186	Safari		☉ 8,2	Ford	Spectron	Minibus, Van	91-03	Rear	↔	
				Isuzu	KB (D-Max), TF Series	4x2 (Mk II)	80-88	Rear	↔	
				Isuzu	KB (D-Max), TF Series	4x4 (Mk II)	80-88	Rear	↔	
				Isuzu	TLD 24	Truck	77-88	Rear	↔	
				Isuzu	Trooper	Mk I	81-91	Rear	↔	
				Mazda	Marathon (Ford Husky)	Van, Bus	91-03	Rear	↔	
				Nissan	Tracker	4x4 (Incl. Sani)	82-88	Rear	↔	
				Toyota	Hilux	4x2	84-98	Rear	↔	
				Toyota	Landcruiser	FJ45, BJ45	71-85	Rear	↔	
				Toyota	Landcruiser	FJ62, BJ60 S/W	83-89	Rear	↔	
G56187	Safari		☉ 8,2	Toyota	Hiace	East Africa	-	Rear	↔	
G56189	Safari		⊥ 6,2	Toyota	Hilux	4x4, 4x2 Raised Susp.	99-05	Front	↔	
G56190	Safari		☉ 8,2	Nissan	1 Ton Bakkie	Hardbody 4x2 (Excl. Hi Rider) (D22)	02 on	Rear	↔	
				Nissan	1 Ton Bakkie	Hardbody 4x2 Hi Rider (D22)	02 on	Rear	↔	
				Nissan	1 Ton Bakkie	Hardbody 4x4 (D22)	98 on	Rear	↔	
				Nissan	NP300	4x2 (Excl. Hi Rider) (D22)	08 on	Rear	↔	
				Nissan	NP300	4x2 Hi Rider (D22)	08 on	Rear	↔	
				Nissan	NP300	4x4 (D22)	08 on	Rear	↔	
				Toyota	Hilux	4x2 Standard Susp.	99-05	Rear	↔	
G56203	Safari		⊥ 6,2	Mahindra	Scorpio	4x4 (Mk I)	06 on	Front	↔	
G56204	Safari		☉ 8,4	Mahindra	Scorpio	4x4 (Mk I)	06 on	Rear	↔	
G56205	Safari		‡ 3,2	Mitsubishi	Triton	4x4, 4x2 Raised Height	07 on	Front	↔	
G56207	Safari		☉ 8,2	Toyota	Hilux	4x4, 4x2 Raised Susp.	05-16	Rear	↔	
G56208	Safari		☉ 8,2	Toyota	Hilux	4x2 Standard Susp.	05-16	Rear	↔	
G56209	Safari		☉ 8,2	Toyota	Quantum	2.5 D-4D, 2.7 Minibus & Van Incl. Sesfikile (H200)	05 on	Rear	↔	
G56210	Safari		☉ 8,2	Mitsubishi	Triton	4x4, 4x2 Raised Height	07 on	Rear	↔	
G56211	Safari		⊥ 6,2	Toyota	Quantum	2.5 D-4D, 2.7 Minibus & Van Incl. Sesfikile (H200)	05 on	Front	↔	
G56212	Safari		‡ 3,2	Isuzu	KB (D-Max), TF Series	4x2 (Standard Height) (P190)	04 on	Front	↔	



Part #	Range	Superceding Part #/Status	Product Type	Make	Model	Derivative	Year	Position	L/R	Note # (pg 6)
G56213	Safari		⊗ 8,2	Isuzu	KB (D-Max), TF Series	4x2 (Standard Height) (P190)	04 on	Rear	↔	
G56214	Safari		⊗ 6,2	Isuzu	KB (D-Max), TF Series	4x4, 4x2 (Raised Height) (P190)	04 on	Front	↔	
G56215	Safari		⊗ 8,2	Isuzu	KB (D-Max), TF Series	4x4, 4x2 (Raised Height) (P190)	04 on	Rear	↔	
G56218	Safari		‡ 3,2	Toyota	Fortuner	4x4, 4x2 Raised Susp.	06-16	Front	↔	
				Toyota	Hilux	4x4, 4x2 Raised Susp.	05-16	Front	↔	
G56219	Safari		⊗ 6,1	Toyota	Fortuner	4x4, 4x2 Raised Susp.	06 on	Rear	↔	
G56222	Safari		⊗ 6,2	Ford	Everest	4x2 & 4x4	09-15	Front	↔	
				Ford	Ranger	4x4, 4x2 Hi-Trail (Raised Susp.)	07-12	Front	↔	
				Mazda	BT-50	4x4, 4x2 Raised Susp.	07-12	Front	↔	
G56223	Safari		⊗ 8,5	Ford	Ranger	4x4, 4x2 Hi-Trail (Raised Susp.)	07-12	Rear	↔	
				Mazda	BT-50	4x4, 4x2 Raised Susp.	07-12	Rear	↔	
G56224	Safari		⊗ 8,5	Opel	Corsa	Utility	04 on	Rear	↔	
G56226	Safari		‡ 3,2	Toyota	Prado	120/125	02-09	Front	↔	
G56227	Safari		⊗ 6,1	Toyota	Prado	120/125	02-09	Rear	↔	
G56228	Safari		⊗ 8,5	Ford	Ranger	4x2 Standard Susp.	07-12	Rear	↔	
				Mazda	BT-50	4x2 Standard Susp.	07-12	Rear	↔	
G56230	Safari		‡ 5	Toyota	Landcruiser	HZJ80 S/W, 105	90-98	Front	↔	
G56231	Safari		⊗ 6,1	Toyota	Landcruiser	100 Series	90-98	Rear	↔	
				Toyota	Landcruiser	HZJ80 S/W, 105	90-98	Rear	↔	
G56235	Safari		⊗ 6,2	Ford	Ranger	4x2 Standard Susp.	07-12	Front	↔	
				Mazda	BT-50	4x2 Standard Susp.	07-12	Front	↔	
G56236	Safari		⊗ 8,3	Nissan	Navara	4x4 & 4x2 (D40)	05 on	Rear	↔	
G56237	Safari		‡ 3,2	Mitsubishi	Pajero	4x4 3.2 Di-D & 3.8 (Mk III)	99-07	Front	↔	
G56239	Safari		‡ 5	Toyota	Landcruiser	79 Series	09 on	Front	↔	
G56240	Safari		⊗ 8,2	Toyota	Landcruiser	79 Series	09 on	Rear	↔	
G56241	Safari		⊗ 6,2	Mitsubishi	Colt Bakkie	L200 (4x4)	98-07	Front	↔	
				Toyota	Hiace	LWB (H20, H30, H40)	84-93	Front	↔	
				Toyota	Hiace	SWB (H20, H30, H40)	84-88	Front	↔	
				Toyota	Hiace	SWB (H50)	88-93	Front	↔	
G56244	Safari		⊗ 6,2	CAM	Inyathi	Minibus	07 on	Front	↔	
G56245	Safari		⊗ 8,2	CAM	Inyathi	Minibus	07 on	Rear	↔	
G56246	Safari		⊗ 10	Land Rover	Discovery	Series II. 4.0 V8, 2.5TD5	98-04	Front	↔	
G56247	Safari		⊗ 8,2	Land Rover	Discovery	Series II. 4.0 V8, 2.5TD5	98-04	Rear	↔	
G56249	Safari		⊗ 6,2	Tata	Xenon	3.0 4x2 & 4x4	07 on	Front	↔	
G56250	Safari		⊗ 8,2	Tata	Xenon	3.0 4x2 & 4x4	07 on	Rear	↔	
G56251	Safari		‡ 4	Kia	K2700	Bongo (Gen 4)	05 on	Front	↔	
G56252	Safari		⊗ 8,2	Kia	K2700	Bongo (Gen 4)	05 on	Rear	↔	
G56254	Safari		⊗ 8,5	Volkswagen	Amarok	4x4, 4x2 D/C & S/C (3+2 Trapezoidal spring)	10 on	Rear	↔	

PARTS LISTING

Shocks & Struts

G56255



Part #	Range	Superceding Part #/Status	Product Type	Make	Model	Derivative	Year	Position	L/R	Note # (pg 6)
G56255	Safari		8.5	Volkswagen	Amarok	4x4, 4x2 D/C & S/C (2+1 Trapezoidal spring)	10 on	Rear	↔	
G56258	Safari		7,1	Fiat	Strada	3/4 Ton LDV (Mk II)	05 on	Rear	↔	
G56262	Safari		3,1	Jeep (Chrysler)	Jeep	Cherokee (KJ) 2.5D, 2.8D, 3.7	01-07	Front	↔	
G56263	Safari		8,5	Jeep (Chrysler)	Jeep	Cherokee (KJ) 2.5D, 2.8D, 3.7	01-07	Rear	↔	
G56266	Safari		8,5	Kia	Sorento	2.5D, 3.5 & 3.8 (Mk I)	02-09	Rear	↔	
G56268	Safari		8,5	Mercedes-Benz	Vito	115 CDi 2.2 Bus MPV Dsl (W639)	04 on	Rear	↔	
				Mercedes-Benz	Vito	115 CDi 2.2 Cr-Cab P-Van Dsl (W639)	04 on	Rear	↔	
				Mercedes-Benz	Vito	115 CDi 2.2 P-Van Dsl (W639)	04 on	Rear	↔	
G56274	Safari		6,2	Mitsubishi	Pajero	4x4 3.2 Di-D & 3.8 (Mk III)	99-07	Rear	↔	
G56276	Safari		3,2	Ford	Ranger	Pick-Up 4x4, 4x2 Raised T6	12-15	Front	↔	
				Mazda	BT-50	4x4, 4x2 Raised Susp.	12-15	Front	↔	
G56277	Safari		8,5	Ford	Ranger	Pick-Up 4x4, 4x2 Raised T6	12-15	Rear	↔	
				Mazda	BT-50	4x4, 4x2 Raised Susp.	12-15	Rear	↔	
G56278	Safari		6,2	Chevrolet	Utility	Utility Pick-Up	11 on	Rear	↔	
G56281	Safari		8,2	Toyota	Vigo	(CGN25)	05 on	Rear	↔	
				Toyota	Vigo	(LAN25)	05 on	Rear	↔	
G56282	Safari		3,2	Toyota	Vigo	(LAN25)	05 on	Front	↔	
G56290	Safari		3,2	Ford	Ranger	Pick-Up 4x2 T6	12-15	Front	↔	
				Mazda	BT-50	4x2 Standard Susp.	12-15	Front	↔	
G56291	Safari		8,5	Ford	Ranger	Pick-Up 4x2 T6	12-15	Rear	↔	
				Mazda	BT-50	4x2 Standard Susp.	12-15	Rear	↔	
G56292	Safari		3,2	Toyota	Prado	SUV 4x4 J150 (Excl. 15)	09 on	Front	↔	
G56293	Safari		6,2	Toyota	Prado	SUV 4x4 J150 (Excl. 15)	09 on	Rear	↔	
G56518	Gas Ryder		1,1	Suzuki	Vitara	5-door (Excl. V6) (Mk I)	94-98	Front	↔	
G63690	Gas Ryder		8,5	Chrysler	Voyager	Gen III (Incl. Grande Voyager) (Excl. 1)	96-00	Rear	↔	
				Chrysler	Voyager	Gen IV (Incl. Grande Voyager) (Excl. 1)	01-07	Rear	↔	
G63720	Gas Ryder		6,2	Kia	Sportage	2.0, 2.0D (Mk I)	93-04	Rear	↔	
G63721	Gas Ryder		4	Jeep (Chrysler)	Jeep	Wrangler 4x4 (TJ)	96-06	Front	↔	
G63722	Gas Ryder		13,2	Jeep (Chrysler)	Jeep	Wrangler 4x4 (TJ)	96-06	Rear	↔	
G63799	Gas Ryder		5	Suzuki	Vitara	5-door (Excl. V6) (Mk I)	94-98	Rear	↔	
G63940	Gas Ryder		6,1	Toyota	Rav 4	Sealed Struts (XA10)	98-00	Rear	↔	
				Toyota	Rav 4	Serviceable Front Struts (XA10) Mk I	95-98	Rear	↔	
GS46006	Safari HDP		3,2	Mitsubishi	Pajero	3.0, 3.8, 3.2 Di-D (Mk IV NS, SWB & LWB)	07 on	Front	↔	
				Mitsubishi	Pajero	4x4 3.2 Di-D & 3.8 (Mk III)	99-07	Front	↔	
GS46007	Safari HDP		3,2	Toyota	Fortuner	4x4, 4x2 Raised Susp.	06-16	Front	↔	33
				Toyota	Hilux	4x4, 4x2 Raised Susp.	05-16	Front	↔	33
				Toyota	Prado	120/125	02-09	Front	↔	33

G56255 - GS46007



Part #	Range	Superceding Part #/Status	Product Type	Make	Model	Derivative	Year	Position	L/R	Note # (pg 6)
GS46008	Safari HDP		‡ 3,2	Toyota	4-Runner/Hilux Surf	VZN185	95-02	Front	↔	
				Toyota	Prado	Land Cruiser 90 SWB	96-02	Front	↔	
				Toyota	Prado	Land Cruiser 95 LWB	96-02	Front	↔	
GS46009	Safari HDP		‡ 3,2	Mitsubishi	Triton	4x4, 4x2 Raised Height	07 on	Front	↔	
GS46010	Safari HDP		‡ 3,2	Nissan	Navara	4x4 & 4x2 (D40)	05-09	Front	↔	
				Nissan	Pathfinder	2.5 DCi, 4.0 (Mk III R51 Series)	05-12	Front	↔	
GS46011	Safari HDP		‡ 3,1	Jeep (Chrysler)	Jeep	Cherokee (KJ) 2.5D, 2.8D, 3.7	01-07	Front	↔	
GS46012	Safari HDP		‡ 3,2	Toyota	FJ Cruiser	FJ Cruiser	11 on	Front	↔	
				Toyota	Prado	SUV 4x4 J150 (Excl. †)	09 on	Front	↔	
GS46013	Safari HDP		‡ 3,2	Ford	Ranger	Pick-Up 4x4, 4x2 Raised T6	12-15	Front	↔	
				Mazda	BT-50	4x4, 4x2 Raised Susp.	12-15	Front	↔	
GS46014	Safari HDP		‡ 3,2	Isuzu	KB (D-Max), TF Series	KB (D-Max), TF Series 4x4, 4x2 (Raised Height) (Mk VI)	13 on	Front	↔	
GS56220	Safari HDP		⊕ 6,2	Mitsubishi	Colt Bakkie	L200 (4x2 Raised Height)	98-07	Front	↔	
				Mitsubishi	Colt Bakkie	L200 (4x4)	98-07	Front	↔	
				Mitsubishi	Pajero	V Series (Mk II)	91-99	Front	↔	
GS56221	Safari HDP		⊕ 6,2	Nissan	1 Ton Bakkie	Hardbody 4x2 Hi Rider (D22)	02 on	Front	↔	
				Nissan	1 Ton Bakkie	Hardbody 4x4 (D22)	98 on	Front	↔	
				Nissan	NP300	4x4 (D22)	08 on	Front	↔	
GS56225	Safari HDP		⊕ 6,2	Isuzu	KB (D-Max), TF Series	4x4, 4x2 (Raised Height) (P190)	04 on	Front	↔	
				Isuzu	KB (D-Max), TF Series	4x4, 4x2 (Raised Height) (TF)	89-04	Front	↔	
GS56232	Safari HDP		⊕ 6,2	Toyota	Hilux	4x4, 4x2 Raised Susp.	99-05	Front	↔	
GS56233	Safari HDP		⊕ 6,2	Ford	Courier	4x4, 4x2 Hi-Trail (Raised Susp.)	86-06	Front	↔	
				Ford	Ranger	4x4, 4x2 Hi-Trail (Raised Susp.)	86-06	Front	↔	
				Ford	Ranger	4x4, 4x2 Hi-Trail (Raised Susp.)	07-12	Front	↔	
				Mazda	B Series, Drifter, Magnum	4x4, 4x2 Hi-Trail (Raised Susp.)	86-06	Front	↔	
				Mazda	BT-50	4x4, 4x2 Raised Susp.	07-12	Front	↔	
GS56234	Safari HDP		⊖ 4	Mitsubishi	Colt Bakkie	L200 (2.6, 3.0, V6 4x4, 4x2 Raised Height)	94-98	Front	↔	
GS56259	Safari HDP		⊕ 8,2	Nissan	Navara	4x4 & 4x2 (D40)	05-09	Rear	↔	
GS56260	Safari HDP		⊕ 8,5	Nissan	Pathfinder	2.5 DCi, 4.0 (Mk III R51 Series)	05-12	Rear	↔	
GS56261	Safari HDP		⊕ 13,1	Jeep (Chrysler)	Jeep	Cherokee (XJ)	96-01	Rear	↔	
GS56264	Safari HDP		⊕ 6,2	Mahindra	Scorpio	4x4, 4x2 Raised (Mk I) 2.2, 2.4D	06 on	Front	↔	
GS56265	Safari HDP		⊕ 8,4	Mahindra	Scorpio	4x4, 4x2 Raised (Mk I) 2.2, 2.4D	06 on	Rear	↔	
GS56267	Safari HDP		⊕ 8,5	Jeep (Chrysler)	Jeep	Cherokee (KJ) 2.5D, 2.8D, 3.7	01-07	Rear	↔	
GS56283	Safari HDP		⊕ 6,2	Suzuki	Jimny	(Gen 3)	98 on	Front	↔	
GS56284	Safari HDP		⊕ 8,5	Suzuki	Jimny	(Gen 3)	98 on	Rear	↔	
GS56288	Safari HDP		⊕ 6,2	Jeep (Chrysler)	Jeep	Wrangler 4x4 (JK)	07-11	Front	↔	
GS56289	Safari HDP		⊕ 13,2	Jeep (Chrysler)	Jeep	Wrangler 4x4 (JK)	07-11	Rear	↔	

PARTS LISTING

Shocks & Struts

GS70760



Part #	Range	Superceding Part #/Status	Product Type	Make	Model	Derivative	Year	Position	L/R	Note # (pg 6)
GS70760	Safari HDP		# 3,3	Volkswagen	Amarok	Pick-Up 4x4, 4x2 Raised	10 on	Front	↔	
GS78000	Safari HDP		1/0 6,2	Toyota	Hilux	4x4	84-98	Front	↔	
GS78001	Safari HDP		0/0 8,2	Toyota	Hilux	4x4	84-98	Rear	↔	
GS78002	Safari HDP		+ 5	Toyota	Land Cruiser	76SW	07 on	Front	↔	
				Toyota	Landcruiser	70/75 S/W	07 on	Front	↔	
				Toyota	Landcruiser	Pickup	99 on	Front	↔	
GS78003	Safari HDP		0/0 8,2	Mitsubishi	Colt Bakkie	L200 (4x2 Raised Height)	98-07	Rear	↔	
				Mitsubishi	Colt Bakkie	L200 (4x4)	98-07	Rear	↔	
GS78004	Safari HDP		0/0 8,2	Toyota	Hilux	4x4, 4x2 Raised Susp.	99-05	Rear	L	
GS78005	Safari HDP		0/0 8,2	Toyota	Hilux	4x4, 4x2 Raised Susp.	99-05	Rear	R	
GS78006	Safari HDP		0/0 8,2	Isuzu	KB (D-Max), TF Series	4x4, 4x2 (Raised Height) (P190)	04 on	Rear	↔	
				Isuzu	KB (D-Max), TF Series	4x4, 4x2 (Raised Height) (TF)	89-04	Rear	↔	
GS78007	Safari HDP		+ 5	Land Rover	Defender	90, 110, 130 (Incl. County & LDV)	84 on	Front	↔	
				Land Rover	Discovery	Series I	89-98	Front	↔	
				Land Rover	Range Rover	Excl. Air Susp. (Mk I)	70-96	Front	↔	
GS78008	Safari HDP		0/0 9,1	Land Rover	Defender	90, 110, 130 (Incl. County & LDV)	84 on	Rear	↔	
				Land Rover	Discovery	Series I	89-98	Rear	↔	
				Land Rover	Range Rover	Excl. Air Susp. (Mk I)	70-96	Rear	↔	
GS78009	Safari HDP		0/0 8,2	Toyota	Hilux	4x4, 4x2 Raised Susp.	05-16	Rear	↔	
GS78010	Safari HDP		1/0 6,1	Toyota	Fortuner	4x4, 4x2 Raised Susp.	06 on	Rear	↔	
GS78011	Safari HDP		+ 5	Toyota	Landcruiser	80	90-98	Front	↔	
				Toyota	Landcruiser	105	99-07	Front	↔	
GS78012	Safari HDP		1/0 6,1	Toyota	Landcruiser	80	90-98	Rear	↔	
				Toyota	Landcruiser	105	99-07	Rear	↔	
GS78013	Safari HDP		0/0 8,2	Toyota	Land Cruiser	76SW	07 on	Rear	↔	
				Toyota	Landcruiser	70/75 S/W	07 on	Rear	↔	
				Toyota	Landcruiser	Pickup	99 on	Rear	↔	
GS78014	Safari HDP		0/0 8,5	Ford	Courier	4x4, 4x2 Hi-Trail (Raised Susp.)	86-06	Rear	↔	
				Ford	Ranger	4x4, 4x2 Hi-Trail (Raised Susp.)	86-06	Rear	↔	
				Ford	Ranger	4x4, 4x2 Hi-Trail (Raised Susp.)	07-12	Rear	↔	
				Mazda	B Series, Drifter, Magnum	4x4, 4x2 Hi-Trail (Raised Susp.)	86-06	Rear	↔	
				Mazda	BT-50	4x4, 4x2 Raised Susp.	07-12	Rear	↔	
GS78015	Safari HDP		1/0 6,1	Toyota	4-Runner/ Hilux Surf	VZN185	95-02	Rear	↔	
				Toyota	Prado	90 SWB & 95 LWB	96-02	Rear	↔	
GS78016	Safari HDP		0/0 8,2	Mitsubishi	Colt Bakkie	L200 (2.6, 3.0, V6 4x4, 4x2 Raised Height)	94-98	Rear	↔	
GS78017	Safari HDP		1/0 6,1	Toyota	Prado	120/125	02-09	Rear	↔	

GS70760 - GS78017

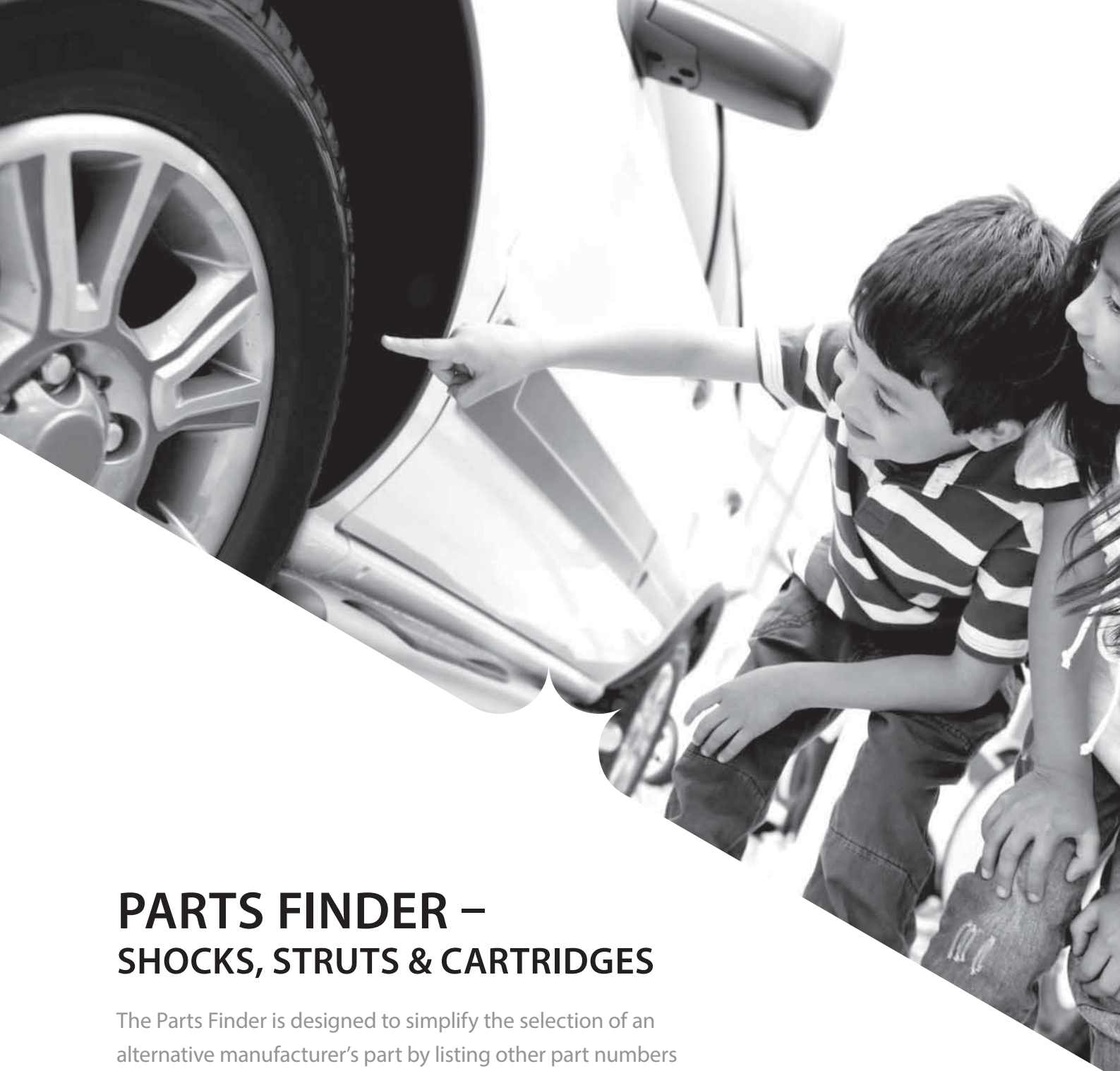

PARTS FINDER – SHOCKS, STRUTS & CARTRIDGES

The Parts Finder is designed to simplify the selection of an alternative manufacturer's part by listing other part numbers in alpha numeric sequence and not by manufacturer.

Where a manufacturer's part number has various Gabriel part numbers that may be used, these are listed as alternatives.

The Gabriel Europe & Gabriel India manufacturing numbers are also listed with the part numbers given as alternatives.

Please note that any reference to brands, trademarks or Manufacturer's part numbers is for reference and identification purposes only.



5794

PARTS FINDER

Shocks, Struts & Cartridges

Part #	Manufacturer	Gabriel	
		Primary	Alternative
5794	Monroe	36866	
5909	Monroe	62011	
7026	Monroe	70703	
10014	Monroe	35831	
10049	Monroe	55868	
10053	Monroe	G35279	
11003	Monroe	44221	
11022	Monroe	70580	
11023	Monroe	70579	
11036	Monroe	35824	
11039	Monroe	35847	
11040	Monroe	35832	
11050	Monroe	55858	
11055	Monroe	55806	
11069	Monroe	55807	
11085	Monroe	35833	
11166	Monroe	55865	
11272	Monroe	70512	
11339	Monroe	70624	
11340	Monroe	70625	
11377	Monroe	35955	
11378	Monroe	35956	
11519	Monroe	G35101	
11580	Monroe	55845	
11654	Monroe	44502	
11743	Monroe	35117	
11779	Monroe	35944	
11780	Monroe	35943	
11781	Monroe	35946	
11782	Monroe	35945	
12644	Monroe	70520	
16072	Monroe	55810	
16077	Monroe	35842	
16211	Monroe	35816	
16214	Monroe	G45399	
16242	Monroe	70511	
16244	Monroe	70519	
		55896	
16245	Monroe	70520	
		55897	

Part #	Manufacturer	Gabriel	
		Primary	Alternative
16248	Monroe	70545	
		70521	
		55895	
		55901	
16249	Monroe	70544	
		70522	
		55894	
		55902	
16264	Monroe	55881	
16269	Monroe	55863	
16275	Monroe	G35301	
16276	Monroe	G35296	
16297	Monroe	70500	
16298	Monroe	70501	
16304	Monroe	G35299	
16305	Monroe	G35284	
16312	Monroe	35952	
16313	Monroe	35951	
16318	Monroe	55825	
16320	Monroe	55891	
16321	Monroe	55890	
16329	Monroe	70504	
16331	Monroe	70526	
16332	Monroe	70525	
16343	Monroe	70537	
16344	Monroe	70536	
16345	Monroe	55889	
16346	Monroe	55888	
16347	Monroe	55890	
		55891	
16352	Monroe	70519	
16356	Monroe	G35214	
16361	Monroe	70551	
16362	Monroe	70550	
16363	Monroe	70549	
16364	Monroe	70548	
16383	Monroe	70568	
16384	Monroe	70567	
16385	Monroe	70568	
16386	Monroe	70567	
16387	Monroe	G35421	

Be safe. Be sure



Part #	Manufacturer	Gabriel	
		Primary	Alternative
16411	Monroe	70654	
16412	Monroe	70655	
16440	Monroe	70540	
		G35338	
16441	Monroe	70539	
		G35337	
		70648	
16472	Monroe	70649	
16508	Monroe	35836	
16511	Monroe	55815	
16517	Monroe	35836	
16541	Monroe	55841	
16555	Monroe	G55592	
16583	Monroe	55834	
16639	Monroe	55834	
16640	Monroe	55835	
16657	Monroe	EG35115	
16660	Monroe	55847	
16662	Monroe	55849	
16681	Monroe	44227	
16688	Monroe	G35225	
16689	Monroe	G35220	
16734	Monroe	G55673	
16749	Monroe	70539	
16776	Monroe	G35214	
16796	Monroe	70683	
16797	Monroe	70684	
19501	Monroe	42942	
21608	Monroe	61241	
21659	Monroe	61285	
22045	Monroe	19021	
22651	Monroe	G45466	
22709	Monroe	36867	
		36867	
23248	Monroe	36850	
23267	Monroe	G45666	
23436	Monroe	61248	
23442	Monroe	G45824	
23442	Monroe	69689	
23728	Monroe	69068	
23729	Monroe	69067	

Part #	Manufacturer	Gabriel	
		Primary	Alternative
23747	Monroe	69075	
23760	Monroe	69076	
23760	Monroe	69067	
23828	Monroe	G51269	
23829	Monroe	G51269	
		69110	
23858	Monroe	69084	
23859	Monroe	G55910	
23869	Monroe	G51214	
23871	Monroe	G55821	
23875	Monroe	G55877	
23895	Monroe	G51214	
23896	Monroe	69989	
		69425	
23904	Monroe	69422	
23910	Monroe	62060	
23935	Monroe	G51275	
23951	Monroe	G51238	
23957	Monroe	69924	
23965	Monroe	61270	
		62005	
23967	Monroe	69538	
23968	Monroe	61296	
23969	Monroe	61295	
23970	Monroe	G51298	
23972	Monroe	62001	
23974	Monroe	70530	
		61284	
23979	Monroe	69506	
23980	Monroe	69107	
		69108	
23982	Monroe	62019	
23983	Monroe	62003	
23988	Monroe	G45894	
23989	Monroe	G45894	
23990	Monroe	62010	
23992	Monroe	G45892	
25504	Monroe	61286	
26327	Monroe	69072	
26340	Monroe	69072	
26624	Monroe	62352	



26635

PARTS FINDER

Shocks, Struts & Cartridges

Part #	Manufacturer	Gabriel	
		Primary	Alternative
26635	Monroe	62353	
33917	KYB	70588	
34905	Monroe	G56102	
34963	Monroe	G45051	
		G45870	
		G56174	
37026	Monroe	G63721	
37027	Monroe	G556261	
37083	Monroe	G578025	
37122	Monroe	G56169	
37135	Monroe	G63722	
37203	Monroe	G56263	
42021	Monroe	G45841	
42041	Monroe	69965	
42060	Monroe	69922	
43001	Monroe	61201	
43013	Monroe	69066	
43027	Monroe	69677	
43050	Monroe	36855	
43070	Monroe	69744	
43082	Monroe	61253	
43095	Monroe	69927	
43109	Monroe	69446	
43110	Monroe	69401	
		69446	
43125	Monroe	61299	
44001	Monroe	62009	
44516	KYB	G55600	
52003	Monroe	36854	
53005	Monroe	55208	
53007	Monroe	61230	
55016	Monroe	61248	
55019	Monroe	69928	
65107	Monroe	76009	
		77012	
65139	Monroe	85320	
65490	Monroe	85319	
66618	Monroe	76110	
66626	Monroe	55232	
		55234	
66653	Monroe	76108	
66675	Monroe	55243	

Part #	Manufacturer	Gabriel	
		Primary	Alternative
66886	Monroe	76007	
70693	KYB	632141	
70694	KYB	632140	
71326	Monroe	69099	
		69100	
71380	Monroe	69104	
71406	Monroe	70522	
71407	Monroe	70521	
71417	Monroe	69099	
71435	Monroe	70554	
71436	Monroe	70555	
71577	Monroe	G56263	
71578	Monroe	55899	
71579	Monroe	55900	
71580	Monroe	55898	
71599	Monroe	69099	
71837	Monroe	G55600	
71959	Monroe	G55679	
71960	Monroe	G55680	
71964	Monroe	G55697	
72170	Monroe	70518	
72171	Monroe	70517	
72222	Monroe	70635	
72286	Monroe	70598	
72287	Monroe	70599	
72288	Monroe	70609	
72289	Monroe	70608	
72295	Monroe	35941	
72296	Monroe	35941	
		35942	
72297	Monroe	G54023	
72298	Monroe	G54024	
74028	Monroe	77018	
		76040	
74074	Monroe	55233	
		76185	
74076	Monroe	76016	
		76043	
74081	Monroe	76204	
74425	Monroe	85724	
77721	Monroe	70636	
234901	KYB	G55680	



Part #	Manufacturer	Gabriel	
		Primary	Alternative
234902	KYB	G55679	
235627	KYB	55898	
235628	KYB	55900	
235629	KYB	55899	
243025	KYB	G56210	
243033	KYB	36865	
270248	KYB	G56258	
323041	KYB	70519	
		70520	
331008	KYB	70649	
331009	KYB	70648	
331017	KYB	G56262	GS46011
		G56263	
331050	KYB	70612	
331051	KYB	70613	
331702	KYB	70506	
331900	KYB	G51217	
332007	KYB	35847	
332009	KYB	55804	
332010	KYB	55804	
332011	KYB	55813	
		G45399	
332012	KYB	55813	
332026	KYB	G45859	
332027	KYB	55817	
332029	KYB	35847	
332054	KYB	55865	
332057	KYB	55856	
332081	KYB	55868	
332088	KYB	55863	
332094	KYB	55870	
332095	KYB	55870	
332100	KYB	G35300	
332101	KYB	G35295	
332108	KYB	55870	
332109	KYB	55870	
332116	KYB	55838	
332117	KYB	55839	
332120	KYB	70700	
332141	KYB	70807	
332142	KYB	70806	
332500	KYB	70570	

Part #	Manufacturer	Gabriel	
		Primary	Alternative
332501	KYB	70569	
332504	KYB	70801	
332505	KYB	70800	
332808	KYB	70723	
		70724	
332807	KYB	35832	
		55803	
333021	KYB	35830	
333022	KYB	35831	
333025	KYB	35832	
333027	KYB	55807	
333028	KYB	55806	
333030	KYB	55810	
333031	KYB	55810	
333051	KYB	55819	
333052	KYB	55819	
333090	KYB	55855	
333114	KYB	55856	
333115	KYB	55812	
333118	KYB	55818	
333119	KYB	55818	
333126	KYB	55825	
333127	KYB	55825	
333179	KYB	55825	
333205	KYB	70520	
333206	KYB	70519	
333211	KYB	55869	
333212	KYB	55869	
333236	KYB	55861	
333237	KYB	55861	
333244	KYB	70535	
333245	KYB	70534	
333246	KYB	70533	
333247	KYB	70532	
333256	KYB	35952	
333257	KYB	35951	
333264	KYB	70526	
333265	KYB	70525	
333274	KYB	55825	
		55890	
333276	KYB	55891	
333298	KYB	35951	



333299

PARTS FINDER

Shocks, Struts & Cartridges

Part #	Manufacturer	Gabriel	
		Primary	Alternative
333299	KYB	35952	
333304	KYB	70625	
333305	KYB	70624	
333308	KYB	70500	
333309	KYB	70501	
333314	KYB	70537	
333315	KYB	70536	
333331	KYB	70610	
333332	KYB	70611	
333338	KYB	55892	
333339	KYB	55893	
333350	KYB	55889	
333351	KYB	55888	
333366	KYB	70551	
333367	KYB	70550	
333368	KYB	70751	
333383	KYB	70568	
333384	KYB	70567	
333390	KYB	70590	
333391	KYB	70589	
333400	KYB	70568	
333401	KYB	70567	
333410	KYB	70611	
333411	KYB	70610	
333417	KYB	35942	
333418	KYB	35941	
333419	KYB	70566	
333420	KYB	70565	
333453	KYB	70580	
333454	KYB	70579	
333464	KYB	35927	
		70510	
333490	KYB	70796	
333491	KYB	70795	
333499	KYB	55833	
		35849	
333500	KYB	70522	
333501	KYB	70521	
333504	KYB	70531	
333505	KYB	70530	
333506	KYB	70549	
333507	KYB	70548	

Part #	Manufacturer	Gabriel	
		Primary	Alternative
333512	KYB	70621	
333513	KYB	70620	
333516	KYB	G54024	
333517	KYB	G54023	
333614	KYB	G35365	
333615	KYB	70600	
333616	KYB	70601	
333709	KYB	G35307	
333710	KYB	G35296	
333712	KYB	55811	
333713	KYB	55881	
333718	KYB	G35421	
333721	KYB	70576	
333722	KYB	70575	
333727	KYB	G35193	
333728	KYB	G35199	
333729	KYB	G35348	
		70539	
333730	KYB	G35347	
333741	KYB	62025	
		70639	
333744	KYB	70682	
333753	KYB	70688	
333754	KYB	70687	
333755	KYB	70504	
		70527	
333756	KYB	55858	
		70527	
333757	KYB	G35369	
333758	KYB	G35369	
		G35370	
333759	KYB	G35326	
333760	KYB	G35326	
333802	KYB	35816	
333831	KYB	55858	
333832	KYB	35842	
333833	KYB	55854	
333841	KYB	35816	
333870	KYB	G35279	
333917	KYB	55835	
333918	KYB	55834	
		70587	



Part #	Manufacturer	Gabriel	
		Primary	Alternative
333930	KYB	G35412	
333942	KYB	G35214	
		70594	
333944	KYB	G35365	
333946	KYB	70504	
334017	KYB	55815	
334056	KYB	55840	
334082	KYB	55844	
334083	KYB	55843	
334084	KYB	55845	
334088	KYB	G55592	
334139	KYB	G56518	
		G63799	
		G63663	
334141	KYB	G55673	
334154	KYB	G35225	
334155	KYB	G35220	
334170	KYB	55847	
334171	KYB	55846	
334178	KYB	55863	
334179	KYB	55863	
334188	KYB	G55697	
334197	KYB	70655	
334198	KYB	70654	
334201	KYB	70657	
334202	KYB	70656	
334231	KYB	35944	
334232	KYB	35943	
334233	KYB	35946	
334234	KYB	35945	
334241	KYB	70523	
		70524	
334251	KYB	70524	
334252	KYB	70523	
334331	KYB	70629	
334332	KYB	70628	
334354	KYB	G35225	
334360	KYB	70557	
334361	KYB	70556	
334362	KYB	70559	
334363	KYB	70558	
334376	KYB	55893	

Part #	Manufacturer	Gabriel	
		Primary	Alternative
334376	KYB	55893	
334377	KYB	55892	
334424	KYB	70728	
334425	KYB	70727	
334438	KYB	70684	
334439	KYB	70683	
334472	KYB	70609	
334473	KYB	70608	
334478	KYB	55849	
334479	KYB	55848	
334500	KYB	70555	
334501	KYB	70554	
334602	KYB	G35290	
		G35289	
334603	KYB	G35289	
334604	KYB	EG35047	
334605	KYB	EG35046	
334607	KYB	70505	
334608	KYB	70505	
334611	KYB	70785	
334615	KYB	70508	
334620	KYB	70538	
334621	KYB	70548	
		70680	
334622	KYB	70548	
		70679	
334623	KYB	70617	
334624	KYB	70616	
334625	KYB	70577	
334626	KYB	70578	
334627	KYB	70578	
334628	KYB	70577	
334642	KYB	70712	
334643	KYB	70711	
334660	KYB	70511	
334700	KYB	70593	
334701	KYB	70592	
334801	KYB	G35101	
334807	KYB	35117	
334810	KYB	55841	
334811	KYB	62022	
334812	KYB	55872	



334815

PARTS FINDER

Shocks, Struts & Cartridges

Part #	Manufacturer	Gabriel	
		Primary	Alternative
334815	KYB	70702	
334816	KYB	70701	
334831	KYB	G35451	
334832	KYB	70619	
334833	KYB	70618	
334834	KYB	70546	
334835	KYB	70503	
334842	KYB	70634	
334843	KYB	70633	
334847	KYB	61918	
334864	KYB	70710	
334903	KYB	EG35115	
334913	KYB	G35216	
334917	KYB	G35160	
334921	KYB	G35189	
334922	KYB	69922	
334925	KYB	70588	
334926	KYB	70587	
334939	KYB	70509	
334946	KYB	70508	
334947	KYB	G35190	
335032	KYB	G56173	
335042	KYB	70518	
335043	KYB	70517	
335607	KYB	70591	
335808	KYB	70546	
		70640	
		70703	
		70775	
335810	KYB	70506	
335811	KYB	G35228	
335812	KYB	G35228	
335815	KYB	70815	
335816	KYB	70814	
335833	KYB	70643	
335834	KYB	70642	
335920	KYB	70602	
335924	KYB	70542	
		70543	
335925	KYB	70542	
		70543	
338001	KYB	70716	

Part #	Manufacturer	Gabriel	
		Primary	Alternative
338002	KYB	70715	
338022	KYB	70794	
338023	KYB	70793	
338064	KYB	70690	
338065	KYB	70689	
338713	KYB	70586	
339029	KYB	70564	
339030	KYB	70563	
339032	KYB	70673	
339031	KYB	70674	
339074	KYB	70598	
339075	KYB	70599	
339086	KYB	55887	
339087	KYB	55886	
339196	KYB	70662	
339197	KYB	70661	
339198	KYB	70664	
339199	KYB	70663	
339261	KYB	70719	
339262	KYB	70718	
339700	KYB	70562	
339701	KYB	70561	
339702	KYB	70631	
		70632	
339703	KYB	70631	
339707	KYB	70764	
339708	KYB	70763	
339716	KYB	70709	
339717	KYB	70708	
339727	KYB	70509	
339728	KYB	70508	
339742	KYB	70637	
339743	KYB	70638	
339746	KYB	70636	
339747	KYB	70535	
339754	KYB	70834	
339755	KYB	70833	
340015	KYB	G56290	
340023	KYB	G56222	
		G56276	
		G56249	
340034	KYB	G56205	

PARTS FINDER

Shocks, Struts & Cartridges

340076



Part #	Manufacturer	Gabriel	
		Primary	Alternative
340076	KYB	69117	
341001	KYB	36760	
341002	KYB	61201	
341031	KYB	69074	
341043	KYB	62351	
341050	KYB	69067	
341080	KYB	62352	
341081	KYB	62353	
341085	KYB	69075	
341088	KYB	55820	
341094	KYB	69076	
341120	KYB	G51213	
341133	KYB	69072	
341144	KYB	62352	
341145	KYB	69110	
341147	KYB	G51059	
341166	KYB	69965	
341189	KYB	69921	
341190	KYB	G51227	
341192	KYB	G51186	
341198	KYB	G55910	
341204	KYB	G51269	
341227	KYB	G51214	
341232	KYB	51240	
341234	KYB	69084	
341239	KYB	69914	
341247	KYB	G56178	
341249	KYB	69401	
		69446	
341250	KYB	69446	
341251	KYB	G56237	
341260	KYB	G51255	
341261	KYB	G51256	
341279	KYB	69093	
341280	KYB	69099	
341281	KYB	69100	
341282	KYB	69093	
341311	KYB	G51298	
341322	KYB	69092	
		69103	
341338	KYB	69092	
341340	KYB	G56226	

Part #	Manufacturer	Gabriel	
		Primary	Alternative
341355	KYB	G56212	
341364	KYB	G45899	
341365	KYB	G45898	
341372	KYB	G56218	
341395	KYB	G51227	
341397	KYB	G45889	
341398	KYB	G45888	
341463	KYB	69104	
341492	KYB	69120	
341684	KYB	46003	G546010
341717	KYB	69119	
		61298	
341814	KYB	62024	
		G51275	
341817	KYB	G51275	
341821	KYB	69106	
341840	KYB	G51216	
341842	KYB	69087	
341845	KYB	69101	
341846	KYB	83367	
341904	KYB	G51101	
341910	KYB	G51238	
341911	KYB	G51239	
341924	KYB	69109	
341952	KYB	G51089	
341953	KYB	69082	
342001	KYB	19021	
342009	KYB	19022	
343005	KYB	G45489	
343007	KYB	G45399	
343017	KYB	82608	
343022	KYB	36850	
343036	KYB	G45841	
343044	KYB	61230	
343046	KYB	36854	
343047	KYB	G45874	
343087	KYB	G45419	
343097	KYB	G45893	
343098	KYB	G45006	
343099	KYB	61252	
343116	KYB	G45078	
343127	KYB	G45255	
343150	KYB	61200	



343152

PARTS FINDER

Shocks, Struts & Cartridges

Part #	Manufacturer	Gabriel	
		Primary	Alternative
343152	KYB	36851	
343154	KYB	G45466	
343157	KYB	G45534	
343169	KYB	69050	
		69089	
343181	KYB	G45417	
343183	KYB	G45824	
		69689	
343185	KYB	G45122	
343187	KYB	G45860	
343189	KYB	61241	
343191	KYB	69068	
343195	KYB	G56158	
343198	KYB	G45905	
343199	KYB	G45870	
		G56186	
		G45904	
343200	KYB	G56102	
343208	KYB	G56171	
343214	KYB	G56116	
343215	KYB	G45871	
		G56173	
343216	KYB	69460	
343228	KYB	G45878	
343231	KYB	36855	
343246	KYB	G56167	
343251	KYB	G45006	
		G56116	
343252	KYB	G56116	G45871
343253	KYB	G56167	
		G578001	
343255	KYB	61248	
343265	KYB	61256	
343271	KYB	G51023	
343272	KYB	G63940	
		62020	
343274	KYB	69081	
343281	KYB	69946	
343287	KYB	G45901	
343288	KYB	G45902	
343289	KYB	69989	

Part #	Manufacturer	Gabriel	
		Primary	Alternative
343290	KYB	69422	
343292	KYB	G56116	
343295	KYB	62060	
343298	KYB	G45900	
343304	KYB	36875	
343308	KYB	G56224	
		69415	
343319	KYB	69924	
343326	KYB	G56116	
343328	KYB	G45879	
343330	KYB	69948	
343334	KYB	G45844	
343336	KYB	G45869	
343337	KYB	G56186	G45870
343338	KYB	G56171	
343342	KYB	G56172	G45869
		G45842	
343343	KYB	G56116	
343344	KYB	G45008	
343346	KYB	G56167	
343348	KYB	61262	
343350	KYB	61256	
343352	KYB	61248	
343353	KYB	61295	
343355	KYB	G56103	
343366	KYB	G56171	
343367	KYB	G56116	G45872
		G56190	
343369	KYB	G56171	
343381	KYB	61296	
343388	KYB	G556260	
343398	KYB	61285	
343405	KYB	62000	
343406	KYB	62040	
343412	KYB	G45892	
343413	KYB	G45894	
		70584	
343419	KYB	62023	
343420	KYB	62055	
343424	KYB	62015	

Be safe. Be sure



Part #	Manufacturer	Gabriel	
		Primary	Alternative
343432	KYB	36867	
		69412	
343442	KYB	G45890	
343459	KYB	62044	
343465	KYB	62006	
343472	KYB	G45891	62038
343478	KYB	G45897	62089
		62089	
343479	KYB	62011	
343482	KYB	62012	
343484	KYB	62008	
343491	KYB	62094	
343807	KYB	62001	
343809	KYB	G45890	
		62090	
344001	KYB	36761	
344004	KYB	G45450	
344031	KYB	G45418	
344041	KYB	G63423	
344044	KYB	G56116	
344058	KYB	G56172	G45869
		G56241	
344059	KYB	G56175	G45873
		G45873	
344060	KYB	G56179	
344063	KYB	G56116	G45006
344064	KYB	G45466	
		G56185	
344085	KYB	G56116	
344088	KYB	G578025	
344102	KYB	G45051	
344105	KYB	G63612	
344115	KYB	69919	
344200	KYB	G45871	
344202	KYB	G56189	
344203	KYB	G56173	
344204	KYB	G56209	
344207	KYB	G56179	
344217	KYB	G56166	
344222	KYB	46004	
344223	KYB	46005	

Part #	Manufacturer	Gabriel	
		Primary	Alternative
344229	KYB	EG63659	
344230	KYB	69901	
344257	KYB	G63935	
344288	KYB	83454	
		83456	
344297	KYB	61284	
344300	KYB	G56274	
344302	KYB	G56178	
		G56251	
344304	KYB	G56170	
344305	KYB	G56169	
344314	KYB	61289	
344318	KYB	55088	
344320	KYB	G56177	
344325	KYB	G56102	
344334	KYB	G56102	
		G56116	
344346	KYB	G56172	
344359	KYB	G63720	
344361	KYB	G56174	
344389	KYB	36859	
344392	KYB	G63721	
344393	KYB	G578025	
344404	KYB	G56263	
344409	KYB	83450	
344410	KYB	G56227	
344418	KYB	G556261	
344420	KYB	G56214	
344421	KYB	G56213	
		G56215	
		G578006	
344446	KYB	62019	
344451	KYB	G56266	
344453	KYB	61287	
344454	KYB	61288	
344456	KYB	62007	
344458	KYB	62010	
344459	KYB	62018	
		62002	
344485	KYB	G56209	
344487	KYB	62021	



344493

PARTS FINDER

Shocks, Struts & Cartridges

Part #	Manufacturer	Gabriel	
		Primary	Alternative
344493	KYB	G56211	
344800	KYB	69538	
344804	KYB	69512	
344807	KYB	61298	
		62003	
344808	KYB	62003	
344810	KYB	62043	
344816	KYB	62102	
345005	KYB	G56165	
		GS78008	
345006	KYB	55227	
345010	KYB	G56231	
345014	KYB	G56164	
		GS78007	
345023	KYB	83456	
		GS78012	
		G56231	
345035	KYB	G56230	
345044	KYB	G56239	
345056	KYB	GS56260	
345076	KYB	62046	
348007	KYB	62016	
348016	KYB	62058	
348027	KYB	G56236	GS56259
348028	KYB	62037	
348053	KYB	62084	
348062	KYB	62091	
349015	KYB	G56207	
349017	KYB	GS78010	
349018	KYB	69415	
349023	KYB	G56208	
349024	KYB	62014	
349035	KYB	61297	
349035	KYB	61297	
349042	KYB	69102	
349052	KYB	61270	
		62005	
349063	KYB	69107	
349063	KYB	69108	
349078	KYB	62033	
349079	KYB	62026	
349087	KYB	62053	

Part #	Manufacturer	Gabriel	
		Primary	Alternative
349090	KYB	G56269	
349098	KYB	62086	
349122	KYB	62082	
349133	KYB	62057	
349138	KYB	62083	
349189	KYB	62036	
349194	KYB	62073	
351700	KYB	G51099	
354003	KYB	GS56261	
362001	KYB	44217	
363014	KYB	G44850	
363017	KYB	G44733	
363023	KYB	44614	
363060	KYB	55818	
363500	KYB	44085	
364001	KYB	44602	
364014	KYB	55811	
365007	KYB	44611	
365015	KYB	44614	
365021	KYB	44601	
365024	KYB	61906	
365043	KYB	61914	
365054	KYB	44933	
365069	KYB	61302	
365076	KYB	44603	
365093	KYB	G44782	
365501	KYB	61909	
		44607	
365504	KYB	61918	
		44411	
366002	KYB	61303	
366012	KYB	G44461	
400033	Gabriel India	55231	
441017	KYB	51309	
441021	KYB	61201	
441042	KYB	51310	
441079	KYB	G51059	
441960	KYB	51310	
442027	KYB	G45861	
443016	KYB	G56153	
443017	KYB	G56156	
443018	KYB	G45837	

Be safe. Be sure



Part #	Manufacturer	Gabriel	
		Primary	Alternative
443020	KYB	44505	
443022	KYB	44516	
443023	KYB	44514	
443045	KYB	G45419	
443046	KYB	18727	
443078	KYB	G56171	
443079	KYB	G45432	
443079	KYB	G56157	
443080	KYB	G56171	
443081	KYB	G56105	
443085	KYB	G45523	
443093	KYB	G45812	
443105	KYB	G45813	
443107	KYB	G45008	
443108	KYB	G45398	
443127	KYB	G45666	
443134	KYB	G45874	
443164	KYB	51016	
443172	KYB	69050	
443181	KYB	G45466	
443186	KYB	G45870	
		G56186	
443188	KYB	G45844	
443190	KYB	G45869	
443206	KYB	69654	
443207	KYB	36857	
443214	KYB	G45862	
443217	KYB	G45870	
443225	KYB	61256	
443226	KYB	G56116	
443236	KYB	69081	
443238	KYB	G56172	G45869
443239	KYB	G56171	
443240	KYB	G56116	G45872
		G56190	
443241	KYB	G56167	
443258	KYB	G56116	
443259	KYB	G56116	G45871
443290	KYB	G56116	
443293	KYB	G56171	
443295	KYB	G56103	
443301	KYB	36875	

Part #	Manufacturer	Gabriel	
		Primary	Alternative
443305	KYB	G56116	
443400	KYB	69412	
443800	KYB	69068	
444023	KYB	G45051	
		G56102	
		G56116	
444025	KYB	G56116	G45006
444026	KYB	G56162	
444036	KYB	G45450	
444039	KYB	G45535	
		G56176	
444042	KYB	G56162	
444043	KYB	G56126	
		G56163	
444054	KYB	G56166	
444062	KYB	G45667	
		G56120	
444077	KYB	G45258	
444083	KYB	76132	
444085	KYB	G56172	G45869
444096	KYB	G56161	
444097	KYB	G56219	
444103	KYB	G56189	
444104	KYB	G56173	
444118	KYB	G45447	
444129	KYB	G56119	
444130	KYB	G56168	
444135	KYB	G56169	
444136	KYB	G56170	
444150	KYB	G56172	
444162	KYB	G56178	
444172	KYB	G56175	G45873
444225	KYB	G56157	
444257	KYB	G56185	
445005	KYB	G56112	
445009	KYB	G56113	
445010	KYB	83233	
445020	KYB	G56161	
445026	KYB	G56164	
445034	KYB	G56164	
445035	KYB	G56246	G578029
445036	KYB	G56247	G578030



445038

PARTS FINDER

Shocks, Struts & Cartridges

Part #	Manufacturer	Gabriel	
		Primary	Alternative
445038	KYB	G56180	
551013	KYB	61902	
551018	KYB	61202	
551019	KYB	36849	
551022	KYB	69066	
551061	KYB	69966	
551805	KYB	42826	
551807	KYB	69928	
		62035	
551900	KYB	G51217	
551921	KYB	69444	
553060	KYB	G56116	
553074	KYB	69677	
553085	KYB	G45523	
553137	KYB	61252	
553177	KYB	69744	
553183	KYB	61253	
553185	KYB	61254	
553200	KYB	69966	
553206	KYB	61262	
553218	KYB	69922	
553219	KYB	69938	
553225	KYB	69989	
553237	KYB	69956	
553241	KYB	62019	
553243	KYB	69507	
553245	KYB	69957	
553306	KYB	62092	
		62004	
553308	KYB	61299	
553337	KYB	42942	
553338	KYB	G56268	
553340	KYB	62030	
553356	KYB	62013	
553365	KYB	62011	
554003	KYB	36761	
554004	KYB	55208	
554006	KYB	G45423	
554017	KYB	G45078	
554036	KYB	G56119	
554038	KYB	G56168	
554063	KYB	G56173	

Part #	Manufacturer	Gabriel	
		Primary	Alternative
554094	KYB	G63720	
554095	KYB	G56176	
554338	KYB	61287	
555004	KYB	G56165	
555608	KYB	61292	
632004	KYB	55804	
632005	KYB	55804	
632040	KYB	55816	
632073	KYB	55855	
632116	KYB	35955	
632117	KYB	35956	
633004	KYB	44221	
633041	KYB	69095	
633137	KYB	55825	
633138	KYB	55825	
633179	KYB	70519	
		55896	
633181	KYB	70545	
		70521	
		55895	
		55901	
633182	KYB	70544	
		70522	
		55894	
		55902	
633204	KYB	35952	
633205	KYB	35951	
633274	KYB	55833	
633712	KYB	55811	
633718	KYB	G35421	
633730	KYB	70540	
633744	KYB	70682	
633807	KYB	35824	
633827	KYB	70511	
633831	KYB	55858	
634001	KYB	35836	
634026	KYB	G55601	
634073	KYB	G56518	
634100	KYB	35944	
634101	KYB	35943	
634102	KYB	35946	
634103	KYB	35945	

Be safe. Be sure



Part #	Manufacturer	Gabriel	
		Primary	Alternative
634810	KYB	55841	
662001	KYB	44227	
663016	KYB	44532	
663017	KYB	44225	
663018	KYB	44535	
664003	KYB	44510	
664007	KYB	44604	
664010	KYB	44564	
665011	KYB	44608	
665015	KYB	G44869	
665020	KYB	44612	
		44502	
665037	KYB	G44939	
665038	KYB	44613	
665042	KYB	44615	
665050	KYB	44601	
665058	KYB	61915	
700060	Gabriel India	61281	
700168	Gabriel India	36860	
700177	Gabriel India	36861	
700178	Gabriel India	36862	
700184	Gabriel India	61283	
700193	Gabriel India	61282	
700979	Gabriel India	36863	
721001	Gabriel Europe	14016	
721002	Gabriel Europe	14017	
721050	Gabriel Europe	14011	
721051	Gabriel Europe	14021	
721052	Gabriel Europe	14022	
721053	Gabriel Europe	14023	
721054	Gabriel Europe	14024	
721057	Gabriel Europe	14032	
721058	Gabriel Europe	14033	
721063	Gabriel Europe	14040	
721583	Gabriel Europe	55872	
722870	Gabriel Europe	42314	
723212	Gabriel Europe	35117	
723501	Gabriel Europe	51006	
723527	Gabriel Europe	51026	
723534	Gabriel Europe	51160	
723538	Gabriel Europe	51310	
723617	Gabriel Europe	G35146	

Part #	Manufacturer	Gabriel	
		Primary	Alternative
731085	Gabriel Europe	G51059	
731102	Gabriel Europe	G51217	
731103	Gabriel Europe	G51216	
731133	Gabriel Europe	G51275	
733256	Gabriel Europe	G55760	
733303	Gabriel Europe	G55757	
733306	Gabriel Europe	G55760	
733313	Gabriel Europe	G55774	
733321	Gabriel Europe	G51186	
733329	Gabriel Europe	G55723	
733335	Gabriel Europe	G55795	
733341	Gabriel Europe	G55805	
733460	Gabriel Europe	G51227	
734372	Gabriel Europe	G55723	
734404	Gabriel Europe	G44706	
734409	Gabriel Europe	G44735	
734420	Gabriel Europe	G44705	
734425	Gabriel Europe	G44733	
734514	Gabriel Europe	G44773	
734534	Gabriel Europe	G44782	
734602	Gabriel Europe	G44869	
734607	Gabriel Europe	G44850	
734609	Gabriel Europe	G44895	
734650	Gabriel Europe	G44938	
734651	Gabriel Europe	G44939	
736001	Gabriel Europe	G51195	
736002	Gabriel Europe	G51196	
736020	Gabriel Europe	G51059	
736055	Gabriel Europe	G51082	
736551	Gabriel Europe	G44450	
736558	Gabriel Europe	G44461	
736701	Gabriel Europe	G56504	
736721	Gabriel Europe	G56504	
736722	Gabriel Europe	G55516	
736727	Gabriel Europe	G55514	
737519	Gabriel Europe	G63410	
737522	Gabriel Europe	G63414	
737532	Gabriel Europe	G63422	
737533	Gabriel Europe	G63423	
737535	Gabriel Europe	G63425	
737904	Gabriel Europe	G63423	
739457	Gabriel Europe	G51255	



739605

PARTS FINDER

Shocks, Struts & Cartridges

Part #	Manufacturer	Gabriel	
		Primary	Alternative
739605	Gabriel Europe	G51089	
739607	Gabriel Europe	G51099	
739608	Gabriel Europe	G51100	
739609	Gabriel Europe	G51101	
739614	Gabriel Europe	G51097	
739617	Gabriel Europe	G51269	
746540	Gabriel Europe	G35216	
746541	Gabriel Europe	G35217	
746545	Gabriel Europe	G35220	
746546	Gabriel Europe	G35225	
746561	Gabriel Europe	G35222	
746566	Gabriel Europe	G35256	
746567	Gabriel Europe	G35261	
746568	Gabriel Europe	G35227	
746569	Gabriel Europe	G35228	
746570	Gabriel Europe	G35214	
746573	Gabriel Europe	G35221	
746578	Gabriel Europe	G35234	
746594	Gabriel Europe	G35288	
746598	Gabriel Europe	G35279	
746631	Gabriel Europe	G35289	
746632	Gabriel Europe	G35290	
746634	Gabriel Europe	G35292	
746635	Gabriel Europe	G35284	
746640	Gabriel Europe	G35295	
746641	Gabriel Europe	G35296	
746644	Gabriel Europe	G35299	
746645	Gabriel Europe	G35300	
746646	Gabriel Europe	G35301	
746650	Gabriel Europe	G35305	
746678	Gabriel Europe	G35326	
746705	Gabriel Europe	G55586	
746713	Gabriel Europe	G55592	
746721	Gabriel Europe	G55601	
746724	Gabriel Europe	G55600	
746773	Gabriel Europe	G55614	
746874	Gabriel Europe	G55652	
746875	Gabriel Europe	G55653	
746879	Gabriel Europe	G35037	
746880	Gabriel Europe	G35038	
746941	Gabriel Europe	G55614	

Part #	Manufacturer	Gabriel	
		Primary	Alternative
746962	Gabriel Europe	G55673	
746971	Gabriel Europe	G35013	
746994	Gabriel Europe	G55679	
746995	Gabriel Europe	G55680	
747021	Gabriel Europe	G35101	
747030	Gabriel Europe	G35112	
747036	Gabriel Europe	G35118	
747037	Gabriel Europe	G35119	
747038	Gabriel Europe	G35120	
747046	Gabriel Europe	G35128	
747086	Gabriel Europe	G35146	
747090	Gabriel Europe	G35150	
747110	Gabriel Europe	G55697	
747115	Gabriel Europe	G35185	
747123	Gabriel Europe	G55910	
747157	Gabriel Europe	G35160	
747171	Gabriel Europe	G35177	
747187	Gabriel Europe	G35189	
747188	Gabriel Europe	G35190	
747191	Gabriel Europe	G35193	
747192	Gabriel Europe	G35194	
747196	Gabriel Europe	G35199	
747512	Gabriel Europe	G63508	
747552	Gabriel Europe	G63612	
747567	Gabriel Europe	G63626	
747576	Gabriel Europe	G63636	
747584	Gabriel Europe	G63659	
747588	Gabriel Europe	G63663	
747603	Gabriel Europe	G63679	
747613	Gabriel Europe	G63694	
747620	Gabriel Europe	G63737	
747939	Gabriel Europe	G63679	
747943	Gabriel Europe	G63690	
747968	Gabriel Europe	G63720	
747969	Gabriel Europe	G63721	
747970	Gabriel Europe	G63722	
748120	Gabriel Europe	G63914	
748141	Gabriel Europe	G63920	
748217	Gabriel Europe	G63935	
748242	Gabriel Europe	G63940	
748609	Gabriel Europe	G63914	

PARTS FINDER

Shocks, Struts & Cartridges

750803



Part #	Manufacturer	Gabriel	
		Primary	Alternative
750803	Gabriel Europe	G35337	
750804	Gabriel Europe	G35338	
750809	Gabriel Europe	G35343	
750810	Gabriel Europe	G35344	
750813	Gabriel Europe	G35347	
750814	Gabriel Europe	G35348	
750827	Gabriel Europe	G35361	
750828	Gabriel Europe	G35362	
750982	Gabriel Europe	G35412	
750983	Gabriel Europe	G35413	
750993	Gabriel Europe	G35361	
750994	Gabriel Europe	G35362	
755539	Gabriel Europe	G55514	
755560	Gabriel Europe	G35347	
755574	Gabriel Europe	G35365	
755580	Gabriel Europe	G35369	
755581	Gabriel Europe	G35370	
755586	Gabriel Europe	G35421	
756574	Gabriel Europe	G35226	
757002	Gabriel Europe	69425	
757046	Gabriel Europe	69512	
757157	Gabriel Europe	G35146	
800375	Gabriel India	55232	
800391	Gabriel India	55233	
800398	Gabriel India	55234	
911123	Monroe	G63690	
931964	Monroe	G55697	
93599614	Gabriel OE	4277	
0C970	Monroe	44611	
15-0202	Monroe	69664	
150804R	Monroe	G56269	
16-0132	Monroe	G56119	
16-0300	Monroe	46005	
		G578019	
16-0366	Monroe	G56169	G556233
16-0367	Monroe	G56170	G578014
16-0369	Monroe	EG63659	
16-0460	Monroe	G56246	G578029
16-0461	Monroe	G56247	G578030
16-0466	Monroe	G56239	

Part #	Manufacturer	Gabriel	
		Primary	Alternative
16-0500	Monroe	G56230	
		G578011	
16-0630	Monroe	G56205	
		G546009	
16-0640	Monroe	G56236	G556259
16-1712	Monroe	G56168	
333492/3	KYB	62086	
35-0550	Monroe	70557	
35-0551	Monroe	70556	
35-0552	Monroe	70559	
35-0553	Monroe	70558	
37289ST	Monroe	62014	
5003211-0301	Gabriel mnf #	76113	
5621ST	Monroe	62016	
5622ST	Monroe	62085	
5645ST	Monroe	62073	
5799ST	Monroe	62015	
66107MM	Monroe	76151	
66626MM	Monroe	76186	
72143ST	Monroe	70612	
72144ST	Monroe	70613	
72219ST	Monroe	70638	
72220ST	Monroe	70637	
72246ST	Monroe	70620	
72247ST	Monroe	70621	
72275ST	Monroe	70673	
72276ST	Monroe	70674	
72295ST	Monroe	35942	
72296ST	Monroe	35941	
72305ST	Monroe	70793	
72306ST	Monroe	70794	
72367ST	Monroe	70711	
72368ST	Monroe	70712	
72401ST	Monroe	69117	
72491ST	Monroe	70718	
72492ST	Monroe	70719	
72497ST	Monroe	69120	
72522ST	Monroe	70771	
72523ST	Monroe	70772	
74076MM	Monroe	77000	
83816A	Monroe	62058	



Part #	Manufacturer	Gabriel	
		Primary	Alternative
83833EA	Monroe	G56255	
84751EA	Monroe	70759	
		G56254	
94144A-B	Monroe	70583	
94176A	Monroe	70594	
94185A	Monroe	70715	
94186A	Monroe	70716	
B0001	Monroe	76017	
B0004	Monroe	76041	
B0005	Monroe	77011	
D0003	Monroe	70614	
		70615	
D0009	Monroe	70523	
		70524	
D0011	Monroe	70628	
		70629	
D0019	Monroe	70556	
		70557	
D0021	Monroe	70558	
		70559	
D0023	Monroe	70661	
		70662	
D0027	Monroe	70663	
		70664	
D0201	Monroe	G56518	
D0202	Monroe	44532	
D0405	Monroe	70642	
		70643	
D0407	Monroe	70542	
		70543	
D0801	Monroe	G44782	
		51309	
D2653	Monroe	G45398	
D4003	Monroe	61292	
D4005	Monroe	62021	
D4044	Monroe	G56126	
		G56163	
D4426	Monroe	G56219	
		G578010	
D4445	Monroe	G56167	
D4462	Monroe	G56171	
D4463	Monroe	G45872	

Part #	Manufacturer	Gabriel	
		Primary	Alternative
D4473	Monroe	G556260	
D4482	Monroe	G56185	
D4484	Monroe	G56174	
D4484	Monroe	G56113	
D4486	Monroe	G56171	
D5467	Monroe	G56158	
D5470	Monroe	46004	
D5471	Monroe	46005	
D5475	Monroe	36761	
D5476	Monroe	G63935	
D6415	Monroe	G56112	
		G56162	
D6437	Monroe	G56164	
D6643	Monroe	G56165	
D7003	Monroe	G56274	
D7004	Monroe	G63720	
D7005	Monroe	G51255	
D7006	Monroe	G51256	
D7007	Monroe	G51227	
D7018	Monroe	62026	
D7019	Monroe	62033	
D7021	Monroe	62038	
D7029	Monroe	G45122	
D7561	Monroe	G45432	
D7633	Monroe	G63799	
		G63940	
		36865	
D7694	Monroe	62020	
D7703	Monroe	G56184	
D7705	Monroe	G45901	
D7706	Monroe	G45902	
D7841	Monroe	G51227	
D8005	Monroe	G56237	
D8014	Monroe	61287	
D8015	Monroe	61288	
D8016	Monroe	G56239	
D8019	Monroe	G56227	
		G578017	
D8020	Monroe	61289	
D8022	Monroe	83455	

PARTS FINDER

Shocks, Struts & Cartridges

D8023



Part #	Manufacturer	Gabriel	
		Primary	Alternative
D8023	Monroe	G56231	
		83456	
		G578012	
D8024	Monroe	G56218	
		G546007	
		G56226	
D8026	Monroe	G45898	
		G45899	
D8028	Monroe	G56266	
D8070	Monroe	46003	GS46010
D8343	Monroe	83454	
		46002	
D8344	Monroe	46001	
		51240	
D8443	Monroe	G45054	
D8465	Monroe	G56173	
D8467	Monroe	G56167	
D8483	Monroe	G56105	
D8641	Monroe	G56180	
D8902	Monroe	G56184	
D9014	Monroe	G56293	
E1007	Monroe	69050	
E1008	Monroe	69068	
E1020	Monroe	61248	
E1042	Monroe	69901	
E1071	Monroe	69081	
E1089	Monroe	G51023	
E1095	Monroe	61256	
E1104	Monroe	69927	
E1115	Monroe	36857	
		61239	
E1162	Monroe	G51089	
E1166	Monroe	G51023	
E1192	Monroe	G51213	
E1203	Monroe	69948	
E1233	Monroe	69425	
E1239	Monroe	69095	
		69082	
		G51235	
E1259	Monroe	69507	
E1274	Monroe	G45879	
E1276	Monroe	G51238	

Part #	Manufacturer	Gabriel	
		Primary	Alternative
E1278	Monroe	G51239	
E1284	Monroe	61298	
E1285	Monroe	61298	
E1286	Monroe	69924	
E1289	Monroe	G51275	
E1292	Monroe	69093	
E1293	Monroe	69415	
E1295	Monroe	G45900	
E1312	Monroe	69092	
E1319	Monroe	69538	
E1325	Monroe	69109	
E1331	Monroe	69512	
E1335	Monroe	69506	
E1336	Monroe	69507	
E1337	Monroe	61293	
		62002	
E1338	Monroe	69987	
E1340	Monroe	70584	
E1341	Monroe	62018	
E1342	Monroe	62023	
E1354	Monroe	62044	
E1355	Monroe	61298	
E1356	Monroe	62003	
E2001	Monroe	62353	
E2020	Monroe	69087	
E2029	Monroe	69926	
E2034	Monroe	G51101	
E2040	Monroe	G51216	
E2041	Monroe	G51216	
E2042	Monroe	69087	
E2048	Monroe	69087	
E2051	Monroe	69946	
E2055	Monroe	69101	
E2056	Monroe	G56214	
E2058	Monroe	G56213	
E2068	Monroe	69102	
E3411	Monroe	44085	
E3454	Monroe	G44461	
E3802	Monroe	61302	
E4201	Monroe	55811	
E4211	Monroe	55854	
E4273	Monroe	55863	



E4341

PARTS FINDER

Shocks, Struts & Cartridges

Part #	Manufacturer	Gabriel	
		Primary	Alternative
E4341	Monroe	55816	
E4342	Monroe	55817	
E4364	Monroe	55858	
E4370	Monroe	70511	
E4386	Monroe	G35296	
E4390	Monroe	G35365	
E4410	Monroe	55815	
E4424	Monroe	55840	
E4489	Monroe	55861	
E4493	Monroe	G35112	
E4499	Monroe	G35128	
		G35292	
E4508	Monroe	EG35115	
E4513	Monroe	55841	
E4555	Monroe	G35160	
E4562	Monroe	G35190	
E4583	Monroe	G35216	
E4585	Monroe	G35189	
E4622	Monroe	G35228	
E4624	Monroe	G35228	
E4628	Monroe	G35227	
E4630	Monroe	70602	
E4631	Monroe	70808	
E4642	Monroe	70633	
		70634	
E4644	Monroe	70814	
		70815	
E4712	Monroe	70710	
E4719	Monroe	70500	
E4733	Monroe	70519	
		70520	
E4743	Monroe	G35300	
E4749	Monroe	G35451	
E4750	Monroe	G35421	
E4879	Monroe	G35288	
E4882	Monroe	70505	
E4886	Monroe	G35199	
E4908	Monroe	61918	
		70505	
E4910	Monroe	70508	
		70509	

Part #	Manufacturer	Gabriel	
		Primary	Alternative
E4912	Monroe	70508	
		70509	
E4963	Monroe	G35289	
		G35290	
E4972	Monroe	69922	
E4973	Monroe	G35348	
		G35412	
		G35413	
E4991	Monroe	70540	
		G35347	
E4997	Monroe	70503	
E5005	Monroe	69965	
E5026	Monroe	61253	
E5027	Monroe	61254	
E5038	Monroe	69919	
E5065	Monroe	69966	
E5066	Monroe	69423	
E5067	Monroe	69952	
E5068	Monroe	69966	
E5069	Monroe	62035	
E5083	Monroe	69956	
E5084	Monroe	69957	
E5090	Monroe	69444	
E5091	Monroe	G51217	
		G51231	
E5098	Monroe	62004	
E5099	Monroe	69446	
E5109	Monroe	61299	
E5116	Monroe	62030	
E5117	Monroe	62032	
E5303	Monroe	69460	
E5309	Monroe	42826	
E5317	Monroe	69938	
E5609	Monroe	69928	
E5615	Monroe	62082	
E7008	Monroe	55892	
		55893	
E7029	Monroe	70546	
E7030	Monroe	70546	
E7032	Monroe	55834	
		55835	
		55835	



Part #	Manufacturer	Gabriel	
		Primary	Alternative
E7036	Monroe	70587	
		70588	
E7038	Monroe	EG35046	
		EG35047	
E7045	Monroe	70631	
E7047	Monroe	70631	
		70632	
E7057	Monroe	70581	
E7068	Monroe	70708	
		70709	
E7070	Monroe	70577	
		70578	
E7082	Monroe	70679	
		70680	
E7808	Monroe	62057	
E8502	Monroe	69119	
G0169	Gabriel India	35934	
G0170	Gabriel India	35935	
G0176	Gabriel India	51168	
G1037	Monroe	62044	
G1055	Monroe	62003	
G1074	Monroe	G45890	
G1084	Monroe	G45897	62089
		62089	
G1095	Monroe	62022	
G1102	Monroe	62000	
G1111	Monroe	62053	
G16289	Monroe	70751	
G16385	Monroe	70567	
G16386	Monroe	70568	
G16387	Monroe	G35421	
G2097	Monroe	G45896	
G2101	Monroe	62018	
G2108	Monroe	62046	
G21659	Monroe	61285	
G7019	Monroe	70723	
G7020	Monroe	70724	
G7203	Monroe	70639	
G72072	Monroe	G45413	
G7265	Monroe	G35370	
G7266	Monroe	G35369	
G7271	Monroe	70611	

Part #	Manufacturer	Gabriel	
		Primary	Alternative
G7272	Monroe	70610	
G7273	Monroe	70689	
G7274	Monroe	70690	
G7275	Monroe	70611	
G7276	Monroe	70610	
G7277	Monroe	70682	
G7288	Monroe	70566	
G7289	Monroe	70565	
G7292	Monroe	70576	
G7293	Monroe	70575	
G7298	Monroe	70545	
G7302	Monroe	G35326	
G7303	Monroe	70600	
G7304	Monroe	70601	
G8005	Monroe	70546	
G8006	Monroe	70560	
G8063	Monroe	70708	
G8064	Monroe	70709	
G8089	Monroe	70564	
G8090	Monroe	70563	
G8091	Monroe	70701	
G8092	Monroe	70702	
G8119	Monroe	70561	
G8120	Monroe	70562	
G8121	Monroe	70618	
G8122	Monroe	70619	
G8126	Monroe	69106	
G8195	Monroe	70806	
G8196	Monroe	70807	
G8801	Monroe	70584	
G8802	Monroe	70585	
G8803	Monroe	70593	
G8804	Monroe	70592	
GA2006	Monroe	G45051	
GA2007	Monroe	G45078	
GA2008	Monroe	G45006	
		G56116	
GA2009	Monroe	G45535	
		G56176	
GA2010	Monroe	G45398	
GA2011	Monroe	G45419	
GA2012	Monroe	G45466	



Part #	Manufacturer	Gabriel	
		Primary	Alternative
GA2015	Monroe	G45813	
		G45841	
GA2016	Monroe	G56160	
GA2018	Monroe	G45875	
GA2019	Monroe	G56161	
GA2020	Monroe	G45877	
GA2021	Monroe	G45844	
GA2022	Monroe	61212	
GA2023	Monroe	G45862	
		G56178	
GA2024	Monroe	G45870	
		G56103	
		G56186	
GA2025	Monroe	G45869	G56172
		G56172	
GA2041	Monroe	G45469	
		69069	
GA2054	Monroe	G45001	
GA2056	Monroe	G45399	
GA2057	Monroe	G45841	
		G45399	
GA2058	Monroe	G45417	
GA2062	Monroe	G45447	
GA2063	Monroe	G45212	
		G56104	
GA2064	Monroe	G45503	
		G45837	
		G56153	
GA2065	Monroe	G45520	
		G56156	
GA2066	Monroe	G45523	
GA2067	Monroe	G45255	
		G45532	
GA2072	Monroe	G45742	
GA2074	Monroe	18727	
GA2075	Monroe	G45812	
GA2077	Monroe	G45810	
GA2078	Monroe	G45838	
GA2080	Monroe	G56159	
GA2081	Monroe	G56177	
GA2097	Monroe	G45470	

Part #	Manufacturer	Gabriel	
		Primary	Alternative
GA72073	Monroe	G45715	
GT0102	Monroe	44602	
GT0104	Monroe	44614	
		44614	
GT0106	Monroe	44608	
GT0107	Monroe	44510	
GT0111	Monroe	44606	
GT0112	Monroe	44615	
GT0114	Monroe	61915	
GT0115	Monroe	44603	
GT0116	Monroe	44611	
GT0117	Monroe	61909	
		44607	
GT0118	Monroe	61914	
GT0119	Monroe	61918	
GT0120	Monroe	44603	
		61903	
		44613	
GT0401	Monroe	44217	
GT0402	Monroe	44535	
GT0701	Monroe	44505	
GT0702	Monroe	44085	
GT0720	Monroe	61903	
GT1001	Monroe	G51023	
GT1002	Monroe	61262	
GT1003	Monroe	G45879	
GT1004	Monroe	69082	
		G51235	
GT1006	Monroe	61298	
		62024	
GT1008	Monroe	G45859	
GT1011	Monroe	69050	
		51006	
GT1012	Monroe	69068	
GT1013	Monroe	69092	
GT1014	Monroe	19022	
GT1015	Monroe	19021	
GT1016	Monroe	69081	
GT1017	Monroe	G51082	
GT1018	Monroe	69082	
GT1021	Monroe	61257	



Part #	Manufacturer	Gabriel	
		Primary	Alternative
GT1024	Monroe	G45839	
GT1025	Monroe	G45874	
GT1026	Monroe	61241	
GT1027	Monroe	G45874	
GT1028	Monroe	61252	
GT1029	Monroe	61256	
GT1030	Monroe	G45881	
GT1033	Monroe	69075	
GT1034	Monroe	55820	
GT1035	Monroe	69093	
GT1059	Monroe	69089	
GT1069	Monroe	G45891	
GT1072	Monroe	62094	
		62006	
GT2001	Monroe	G45878	
GT2002	Monroe	G45869	
GT2026	Monroe	55088	
		55211	
GT2027	Monroe	36857	
GT2028	Monroe	G45466	
GT2030	Monroe	G45871	
GT2031	Monroe	G56116	
GT2032	Monroe	G45876	
GT2033	Monroe	36859	
GT2035	Monroe	G56178	
GT2036	Monroe	G45008	
GT2039	Monroe	G56172	
GT2042	Monroe	G45489	
		61230	
		G45138	
GT2043	Monroe	61248	
GT2044	Monroe	G56103	
GT2045	Monroe	G56189	
GT2046	Monroe	G56167	
GT2050	Monroe	69073	
GT2051	Monroe	69079	
GT2082	Monroe	G56224	
GT2083	Monroe	G45860	
GT2084	Monroe	G45535	
		G56244	
GT2085	Monroe	36767	

Part #	Manufacturer	Gabriel	
		Primary	Alternative
GT2090	Monroe	69074	
GT2091	Monroe	G45889	
GT2092	Monroe	G45888	
GT2093	Monroe	G56208	
GT2094	Monroe	G56211	
GT2096	Monroe	G45873	
		G56175	
GT2102	Monroe	G56209	
		G56245	
GT2107	Monroe	G56212	
GT2109	Monroe	G56252	
GT2202	Monroe	69101	
GT2203	Monroe	51309	
		62350	
GT2213	Monroe	61293	
GT7001	Monroe	35847	
GT7002	Monroe	35847	
GT7005	Monroe	55813	
GT7006	Monroe	55813	
GT7007	Monroe	55813	
GT7008	Monroe	55813	
GT7101	Monroe	55881	
GT7206	Monroe	55865	
GT7207	Monroe	70510	
GT7208	Monroe	70504	
GT7209	Monroe	70504	
GT7210	Monroe	55858	
GT7211	Monroe	35832	
		55803	
GT7216	Monroe	55806	
GT7217	Monroe	55807	
GT7218	Monroe	55812	
GT7219	Monroe	55812	
GT7220	Monroe	35830	
GT7226	Monroe	55812	
GT7227	Monroe	55812	
GT7228	Monroe	55825	
GT7229	Monroe	55804	35833
GT7230	Monroe	35816	
		35844	
GT7231	Monroe	55817	



GT7232

PARTS FINDER

Shocks, Struts & Cartridges

Part #	Manufacturer	Gabriel	
		Primary	Alternative
GT7232	Monroe	55816	
GT7233	Monroe	55854	
GT7234	Monroe	55840	
GT7235	Monroe	55855	
GT7236	Monroe	35816	
		55801	
GT7237	Monroe	35817	
		55802	
GT7238	Monroe	35842	
GT7239	Monroe	55838	
		55839	
GT7240	Monroe	55839	
GT7241	Monroe	G35146	
GT7242	Monroe	55819	
GT7243	Monroe	55819	
GT7244	Monroe	55863	
GT7245	Monroe	55863	
GT7249	Monroe	55811	
GT7251	Monroe	55825	
		35848	
GT7252	Monroe	35927	
GT7255	Monroe	55804	
GT7259	Monroe	70501	
GT7260	Monroe	70500	
GT7263	Monroe	70527	
GT7264	Monroe	70527	
GT7278	Monroe	55833	
		35849	
GT7279	Monroe	70590	
GT7280	Monroe	70589	
GT7292	Monroe	70575	
GT7298	Monroe	70531	
GT8020	Monroe	55872	
GT8021	Monroe	55893	
GT8022	Monroe	55892	
GT8023	Monroe	70503	
GT8026	Monroe	55856	
GT8028	Monroe	55844	
GT8029	Monroe	55843	
GT8030	Monroe	55845	
GT8031	Monroe	55840	

Part #	Manufacturer	Gabriel	
		Primary	Alternative
GT8032	Monroe	55855	
GT8033	Monroe	55848	
GT8034	Monroe	55849	
GT8035	Monroe	55846	
GT8036	Monroe	55847	
GT8037	Monroe	55841	
GT8038	Monroe	55886	
GT8039	Monroe	55887	
GT8042	Monroe	55861	
GT8043	Monroe	55861	
GT8044	Monroe	55818	
GT8046	Monroe	55818	
GT8047	Monroe	55818	
GT8050	Monroe	55835	
		70588	
GT8051	Monroe	70587	
GT8057	Monroe	70560	
GT8058	Monroe	70546	
GT8059	Monroe	35937	
GT8060	Monroe	35936	
GT8061	Monroe	35939	
GT8062	Monroe	35938	
GT8123	Monroe	70714	70503
M0201	Monroe	G56518	
M1971	Monroe	61902	
M315	Monroe	61303	
M4434	Monroe	G56179	
M4441	Monroe	G45008	
		G45870	
		G56103	
		G56186	
M4445	Monroe	G56167	
M4462	Monroe	G45844	
		G56171	
		G45842	
M4463	Monroe	G56116	G45872
M4464	Monroe	55088	
		76132	
M4465	Monroe	G63612	
M4479	Monroe	EG63659	



Part #	Manufacturer	Gabriel	
		Primary	Alternative
M5454	Monroe	G56158	
		GS78000	
		G56173	
		G56244	
M5468	Monroe	G56178	
		G56251	
M5470	Monroe	46004	
M6409	Monroe	G56240	
M6432	Monroe	G56189	
M6433	Monroe	G56231	
M6440	Monroe	G56165	
M6628	Monroe	GS78007	
M6629	Monroe	GS78008	
M6902	Monroe	G56184	
		36860	
		G56250	
M7299	Monroe	46004	
M7300	Monroe	46005	
M7366	Monroe	55231	
		G56249	
M8029	Monroe	G56190	
M8030	Monroe	G56171	
M8031	Monroe	G56214	
		G556225	
M8032	Monroe	G56213	
		G56215	
		GS78006	
M8034	Monroe	G56123	
M8035	Monroe	G56155	
M8036	Monroe	G56112	
		G56162	
M8037	Monroe	G56163	
M8038	Monroe	G45006	
		G56102	
		G56116	G45006
M8039	Monroe	G56102	
M8041	Monroe	55227	
M8042	Monroe	G56103	
M8046	Monroe	G45869	
		G56172	G45869
M8047	Monroe	G56211	

Part #	Manufacturer	Gabriel	
		Primary	Alternative
M8048	Monroe	G56175	G45873
M8049	Monroe	G45432	
		G56157	
M8050	Monroe	G56172	
M8052	Monroe	GS78003	
M8055	Monroe	G56218	
M8056	Monroe	G56207	
M8056	Monroe	GS78009	
M8058	Monroe	G45871	
M8059	Monroe	G56116	
M8067	Monroe	G56219	
M8073	Monroe	G56223	
M8074	Monroe	G56209	
		G56245	
MG310	Monroe	61303	
MG971	Monroe	44601	
		61906	
MG998	Monroe	61914	
ML0023	Monroe	4081	
ML0250	Monroe	4501	
		4312	
ML0265	Monroe	4321	
ML0299	Monroe	4324	
ML1133	Monroe	4332	
ML1233	Monroe	4320	
ML1250	Monroe	4260	
ML1361	Monroe	4328	
ML1413	Monroe	4063	
ML1418	Monroe	4333	
ML1485	Monroe	4064	
ML1514	Monroe	4221	
ML1653	Monroe	4277	
		4308	
ML1881	Monroe	4079	
ML2029	Monroe	4272	
ML2125	Monroe	4291	
ML2173	Monroe	4330	
ML2209	Monroe	4076	
ML2231	Monroe	4289	
ML2417	Monroe	4325	
ML2469	Monroe	4082	



ML2477

PARTS FINDER

Shocks, Struts & Cartridges

Part #	Manufacturer	Gabriel	
		Primary	Alternative
ML2477	Monroe	4065	
ML2489	Monroe	4314	
ML2670	Monroe	4329	
ML2800	Monroe	4316	
ML2841	Monroe	4327	
ML3007	Monroe	4331	
ML3095	Monroe	4313	
ML3397	Monroe	4298	
ML3657	Monroe	4270	
ML4149	Monroe	4284	
		4325	
ML4257	Monroe	4060	
MR819	Monroe	44225	
MR839	Monroe	44564	
MR916	Monroe	44604	
MR937	Monroe	44612	
MR951	Monroe	44614	
MR969	Monroe	G44850	
MR993	Monroe	44615	
PL15001	Autocom	55818	
PL15002	Autocom	55819	
PL15003	Autocom	G45869	
PL15004	Autocom	G45873	
PL15005	Autocom	G56211	
PL15006	Autocom	G56209	
PL15008	Autocom	G45871	
PL15009	Autocom	G45872	
PL15010	Autocom	55861	
PL15011	Autocom	55863	
PL15012	Autocom	55833	
PL15013	Autocom	69050	
PL15014	Autocom	69068	
PL15015	Autocom	G45862	
PL15016	Autocom	G45008	
PL15018	Autocom	G56190	
PL15021	Autocom	G45466	
PL15022	Autocom	70714	
PL15023	Autocom	G45879	
PL15024	Autocom	70527	
PL15025	Autocom	G56224	
PL15026	Autocom	G45844	

Part #	Manufacturer	Gabriel	
		Primary	Alternative
PL15027	Autocom	G45870	
PL15028	Autocom	G56189	
PL15029	Autocom	55893	
PL15030	Autocom	55892	
PL15031	Autocom	69092	
PL15032	Autocom	G56169	
PL15033	Autocom	G56170	
PL15034	Autocom	G56214	
PL15035	Autocom	G56215	
R1000	Monroe	G45006	
R1581	Monroe	G45418	
		G63423	
R1610	Monroe	G56175	
R1611	Monroe	G56119	
		G56168	
R1613	Monroe	G45871	
R1643	Monroe	36875	
R2029	Monroe	36760	
R2030	Monroe	36761	
R2592	Monroe	G45417	
R2602	Monroe	G45651	
R2605	Monroe	44516	
R2632	Monroe	61252	
R2646	Monroe	61256	
R2659	Monroe	G45535	
R2713	Monroe	69050	
R2714	Monroe	69068	
R2715	Monroe	14032	
R2716	Monroe	14011	
		14013	
R2719	Monroe	51016	
R2720	Monroe	51168	
R2721	Monroe	G56203	G556264
R2722	Monroe	G56204	G556265
R2724	Monroe	61202	
R2773	Monroe	61283	
		G45885	
R2775	Monroe	G45886	
		36862	
R2778	Monroe	61281	



Part #	Manufacturer	Gabriel	
		Primary	Alternative
R3216	Monroe	G56118	
		G45533	
R3269	Monroe	36849	
R3277	Monroe	19289	
		44227	
R3282	Monroe	36853	
R3405	Monroe	G45861	
R3410	Monroe	G45858	
R3469	Monroe	70532	
		70533	
R3472	Monroe	69921	
R3724	Monroe	36851	
R3737	Monroe	G55723	
R3750	Monroe	69076	
R3758	Monroe	G45861	
		G51059	
R3759	Monroe	55810	
R3769	Monroe	G55910	
R3776	Monroe	G51186	
R4434	Monroe	G56179	
		G56166	
R5410	Monroe	G45258	
R5522	Monroe	61282	
R6507	Monroe	51310	
R6519	Monroe	51310	
R7001	Monroe	55870	
R7002	Monroe	55870	
R7101	Monroe	55869	
R7202	Monroe	55811	
R7203	Monroe	35935	
R7204	Monroe	35934	
R7210	Monroe	55833	
R8001	Monroe	G35348	
R8002	Monroe	G35347	
RS5602	Monroe	G556234	
RS999010	Monroe	G578003	
RS999039	Monroe	G556233	
RS999113	Monroe	G578018	
		G578021	
RS999116	Monroe	G578016	
		G556225	

Part #	Manufacturer	Gabriel	
		Primary	Alternative
RS999129	Monroe	G556261	
RS999136	Monroe	G578000	
		G578001	
		G578004	
		G578009	
RS999144	Monroe	G578005	
		G556232	
		G578002	
RS999158	Monroe	G578002	
RS999188	Monroe	G556221	
RS999202	Monroe	G56240	
		G578013	
RS999207	Monroe	G578011	
RS999213	Monroe	G578019	
RS999223	Monroe	G556220	
RS999284	Monroe	G556267	G56263
RS999311	Monroe	G556259	G56236
RS999321	Monroe	G578014	
RS999328	Monroe	G556289	
RS999352	Monroe	G578015	
RS999357	Monroe	G578017	
RS999360	Monroe	G578029	G56246
RS999361	Monroe	G578030	G56247
RS999365	Monroe	G578020	
RS999764	Monroe	G56263	
RS999766	Monroe	G546008	
		G546007	
RS999777	Monroe	G56226	
		G546010	46003
RS999787	Monroe	G546010	46003
RS999802	Monroe	G546006	
S1003	Monroe	G45874	
S1007	Monroe	69050	
S1042	Monroe	69901	
S1043	Monroe	61252	
S1047	Monroe	G45860	
S1148	Monroe	G45893	
S1203	Monroe	69948	
S1233	Monroe	69989	
S1242	Monroe	69422	
S1251	Monroe	69431	
S1264	Monroe	61262	
S3009	Monroe	55811	



S3404

PARTS FINDER

Shocks, Struts & Cartridges

Part #	Manufacturer	Gabriel	
		Primary	Alternative
S3404	Monroe	61918	
S3405	Monroe	61909	
S3804	Monroe	61302	
S4010	Monroe	55868	
S4031	Monroe	G35279	
S4032	Monroe	55870	
S4252	Monroe	55813	
S4255	Monroe	55856	
S4277	Monroe	55812	
		55861	
S4299	Monroe	55807	
S4334	Monroe	55869	
S4342	Monroe	55817	
S4343	Monroe	G45859	
S4386	Monroe	G35301	
S4388	Monroe	G35295	
S4424	Monroe	55840	
S4441	Monroe	G55592	
S4545L	Monroe	55846	
S4547	Monroe	55848	
S4562	Monroe	G35190	
S4571	Monroe	G55601	
S4572	Monroe	55843	
S4596	Monroe	EG35046	
S4853	Monroe	G55673	
S4858	Monroe	55872	
S4865	Monroe	55844	
S4886	Monroe	G35193	
S4910	Monroe	70509	
S4914	Monroe	70508	
S5017	Monroe	61202	
S5057	Monroe	69677	
S5082	Monroe	G45078	
S5085	Monroe	69401	
S5087	Monroe	69946	
SA1942	Monroe	14023	
SC2914	Monroe	14021	
SC2946	Monroe	14023	
SC2947	Monroe	14033	
SF4004T	Titan	G45871	
SF4005T	Titan	G56169	

Part #	Manufacturer	Gabriel	
		Primary	Alternative
SF4006T	Titan	70510	
SF4009T	Titan	55825	
SF4010T	Titan	G56222	
SF4501T	Titan	70527	
SF4502T	Titan	55858	
SF4506T	Titan	61918	
SF4602T	Titan	G56173	
SF4605T	Titan	G56214	
SF4606T	Titan	G45844	
SF4611T	Titan	G56176	
SF5402T	Titan	G56178	
SF6001T	Titan	G56172	
SF6003T	Titan	44217	
SF6004T	Titan	G56171	
SF8001T	Titan	G45869	G56172
SF8002T	Titan	55818	
SF8005T	Titan	G45862	
SF8006T	Titan	G56211	
SF8007T	Titan	G45466	
SF8011T	Titan	55861	
SF8013T	Titan	G56189	
SF8014T	Titan	55893	
SF8015T	Titan	55892	
SF8016T	Titan	G56218	
SF8019T	Titan	G56185	
SF8301T	Titan	55833	
SF8302T	Titan	70503	
SF8306T	Titan	55841	
SF8308T	Titan	55811	
SH136001	Femo	61909	
SH136555	Femo	61918	
SH140521	Femo	44217	
SH141571	Femo	61903	
SH151720	Femo	G45051	
SH155210	Femo	61256	
SH155490	Femo	G45879	
SH185515	Femo	61248	
SH186060	Femo	69050	
SH186066	Femo	69068	
SH186132	Femo	69089	
SH186578	Femo	69092	



Part #	Manufacturer	Gabriel	
		Primary	Alternative
SH205510	Femo	G56211	
SH212020	Femo	55865	
SH212030	Femo	70510	
SH235623	Femo	55858	
SH236569	Femo	70503	
SH236625	Femo	55812	
SH236626	Femo	55813	
SH236737	Femo	55825	
SH236797	Femo	55854	
SH236811	Femo	55839	
SH236812	Femo	55838	
SH237245	Femo	55804	
SH237338	Femo	55811	
SH237339	Femo	55818	
SH237340	Femo	55819	
SH237341	Femo	55833	
SH237344	Femo	55861	
SH237345	Femo	55863	
SH237384	Femo	55841	
SH241850	Femo	35927	
SH255430	Femo	55088	
SH255730	Femo	G56116	
SH865690	Femo	G45873	
SH865700	Femo	G45869	
SH865710	Femo	G45535	
SH866530	Femo	G45813	
SH866550	Femo	G45844	
SH866730	Femo	G45870	
SH866735	Femo	G45871	
SH866740	Femo	G45872	
SH866750	Femo	G45878	
SH867510	Femo	G45008	
SH872080	Femo	G56172	
SH872085	Femo	G56171	
SH872090	Femo	G56173	
SH872100	Femo	G56178	
SH876510	Femo	G45862	
		G56103	
SH876715	Femo	G45466	
		G56102	
SH876720	Femo	G56167	

Part #	Manufacturer	Gabriel	
		Primary	Alternative
SH876725	Femo	G56158	
SH876730	Femo	G56169	
SH876735	Femo	G56170	
SH876745	Femo	G56175	
SH876750	Femo	G56186	
SH876755	Femo	G56184	
SH876760	Femo	G56190	
SH876765	Femo	G56189	
SR2401T	Titan	61248	
SR4001T	Titan	G45051	
SR4002T	Titan	G45872	
SR4003T	Titan	G45878	
SR4007T	Titan	55804	
SR4008T	Titan	G56170	
SR4011T	Titan	G56223	
SR4503T	Titan	61256	
SR4504T	Titan	G56224	
SR4505T	Titan	G45874	
SR4601T	Titan	G56116	
SR4603T	Titan	G45870	
SR4604T	Titan	G45008	
SR4607T	Titan	G56186	
SR4608T	Titan	G45006	
SR4609T	Titan	G56215	
SR4610T	Titan	G56213	
SR4801T	Titan	G56102	
SR5401T	Titan	G56103	
SR6005T	Titan	G56184	
SR8002T	Titan	G56190	
SR8003T	Titan	55819	
SR8004T	Titan	G45873	
SR8008T	Titan	55863	
SR8009T	Titan	G56209	
SR8010T	Titan	G56167	
SR8012T	Titan	69092	
SR8017T	Titan	G56207	
SR8018T	Titan	G45891	
SR8303T	Titan	G45879	
SR8304T	Titan	69068	
SR8305T	Titan	69050	
SR8307T	Titan	69081	

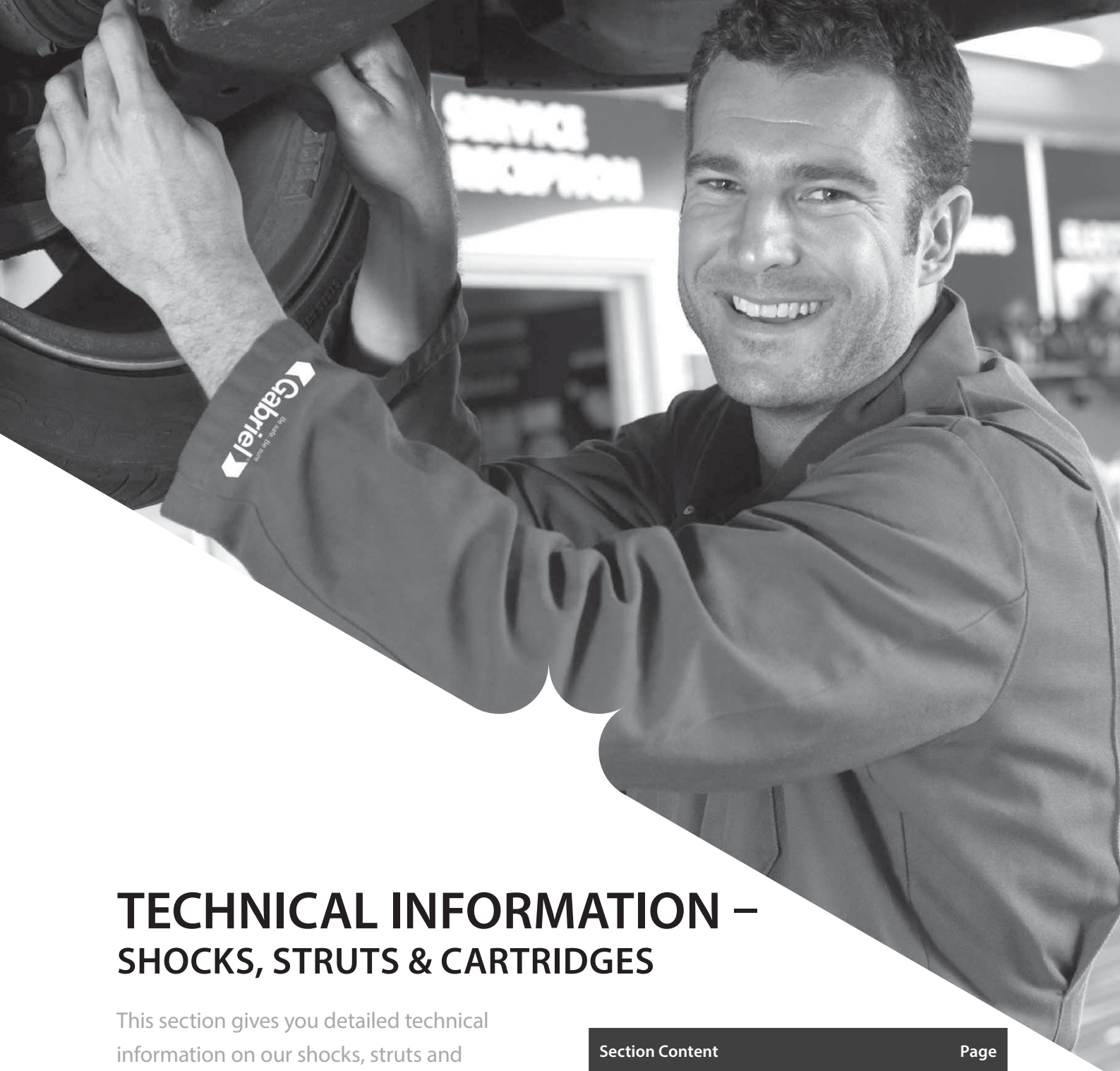

TECHNICAL INFORMATION – SHOCKS, STRUTS & CARTRIDGES

This section gives you detailed technical information on our shocks, struts and cartridges. This includes technical guides, drawings, and end mounting details, all of which is referenced to and from the vehicle listing and the parts listing.

Included in this section is a Fitment Guide which provides additional information on the removal, fitment and disposal of our products, as well as a section on extended and collapsed lengths that gives you the dimensions of our products as well as the end mountings and accessory packs that come with the product.

Section Content	Page
Key to Mounting Codes	154
How to Measure Extended and Collapsed Lengths	154
How to Protect your Struts	154
Technical guide to drawings	155
Removal and fitment of shocks	156
Removal and fitment of struts	157
Parts Listing	158



KEY TO MOUNTING CODES

Rubber Eyes		Sleeved Eyes		Other	
RE 16 = 16 mm I.D	SE 9 = 9 mm I.D	SE 16 = 16 mm I.D	B = Bracket	P = Plate	
RE 17 = 17 mm I.D	SE 10 = 10 mm I.D	SE 19 = 19 mm I.D	BP = Bar Pin	S = Stud	
RE 20 = 20 mm I.D	SE 11 = 11 mm I.D	SE 20 = 20 mm I.D	BT = Bolt	SM = Special Mounting	
RE 22 = 22 mm I.D	SE 12 = 12 mm I.D	SE 22 = 22 mm I.D	C = Cartridge	SS = Spring Seat Stud	
RE 25 = 25 mm I.D	SE 13 = 13 mm I.D	SE 24 = 24 mm I.D	DS = Dual Stud	SSE = Spring Seat Sleeved Eye	
	SE 14 = 14 mm I.D	SE 25 = 25 mm I.D	I.D = Inner Diameter	UB = U Bracket	
	SE 15 = 15 mm I.D	SE 31 = 31 mm I.D			

HOW TO MEASURE EXTENDED AND COLLAPSED LENGTHS

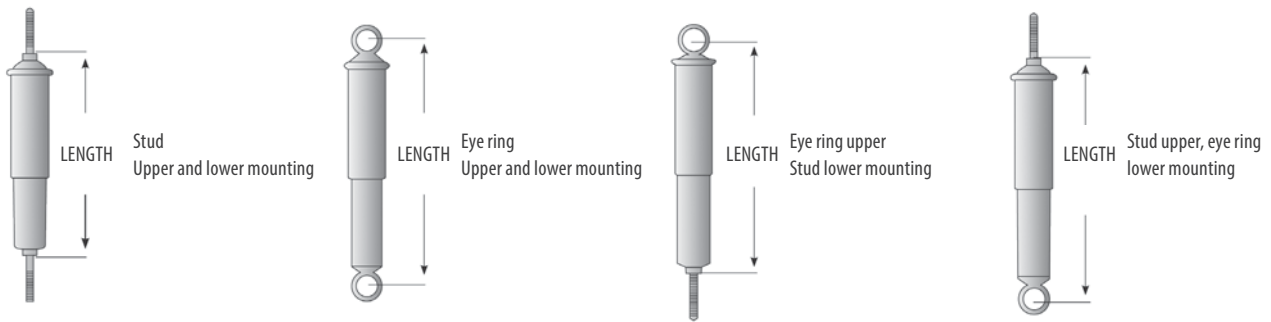

HOW TO PROTECT YOUR STRUTS

PART NO: 143057



GABRIEL STRUT CUSHION

Torre Parts and Components wants to emphasize the importance of renewing damaged or missing strut cushions (bump rubbers).

Damaged or missing strut cushions that are not replaced during strut and cartridge fitments can cause premature strut failure.

A strut cushion consists of a convoluted rubber boot or gaiter and a urethane compression bumper. These fit together and slide over the piston rod to rest on the strut's body.

The gaiter protects the strut's chrome piston rod from damage, keeps dirt out of the seal, pitting from stone chippings and corrosion from whatever the road may throw up.

The compression bumper, which fits into the boot, avoids internal damage being caused by preventing metal-to-metal contact under severe compression of the piston rod.



TECHNICAL GUIDE TO DRAWINGS

FIG 1 MacPherson Struts		FIG 2 MacPherson Cartridges		FIG 3 Spring Seat Shock			
FIG 1.1	FIG 1.2	FIG 2		FIG 3.1	FIG 3.2	FIG 3.3	FIG 3.4
With spring seat	Without spring seat	MacPherson Cartridges		With Bracket	With Sleeved Eye With/Without Seat	With U Bracket	With Sleeved Eye & Sleeved Eye
FIG 4 Stud & Barpin Shock		FIG 5 Stud & Stud Shock		FIG 6 Stud & Eye Shock (With or Without Dust Cover)		FIG 7 Stud & Special Mounting Shock	
FIG 4		FIG 5		FIG 6.1	FIG 6.2	FIG 7	
Stud & Barpin Shock Absorbers		Stud & Stud Shock Absorbers		Stud & Rubber Eye	Stud & Sleeved Eye	NB: Special mountings come in numerous forms. e.g with special bracket as illustrated.	
FIG 8 Eye & Eye Shock					FIG 9 Eye & Stud Shock		FIG 10 Eye & Barpin Shock
FIG 8.1	FIG 8.2	FIG 8.3	FIG 8.4	FIG 8.5	FIG 9.1	FIG 9.2	FIG 10
Bolt & Sleeved eye	Rubber Eye & Rubber Eye	Rubber eye & Sleeved eye	Sleeved Eye & Rubber Eye	Sleeved Eye & Sleeved Eye	Rubber Eye & Stud	Sleeved Eye & Stud	Sleeved Eye & Barpin
FIG 11 Eye & Special Mounting Shock		FIG 12 Barpin & Stud Shock		FIG 13 Barpin & Eye Shock		FIG 14 Gaslifts	FIG 15 Steering Dampers
FIG 11.1	FIG 11.2	FIG 12		FIG 13.1	FIG 13.2	FIG 14	FIG 15
NB: Special mountings come in numerous forms. e.g with special bracket as illustrated.		Barpin & Stud Shock Absorbers		Rubber eye	Sleeved eye	Gaslifts	Steering Dampers



REMOVAL AND FITMENT OF SHOCKS

REMOVAL OF SHOCKS

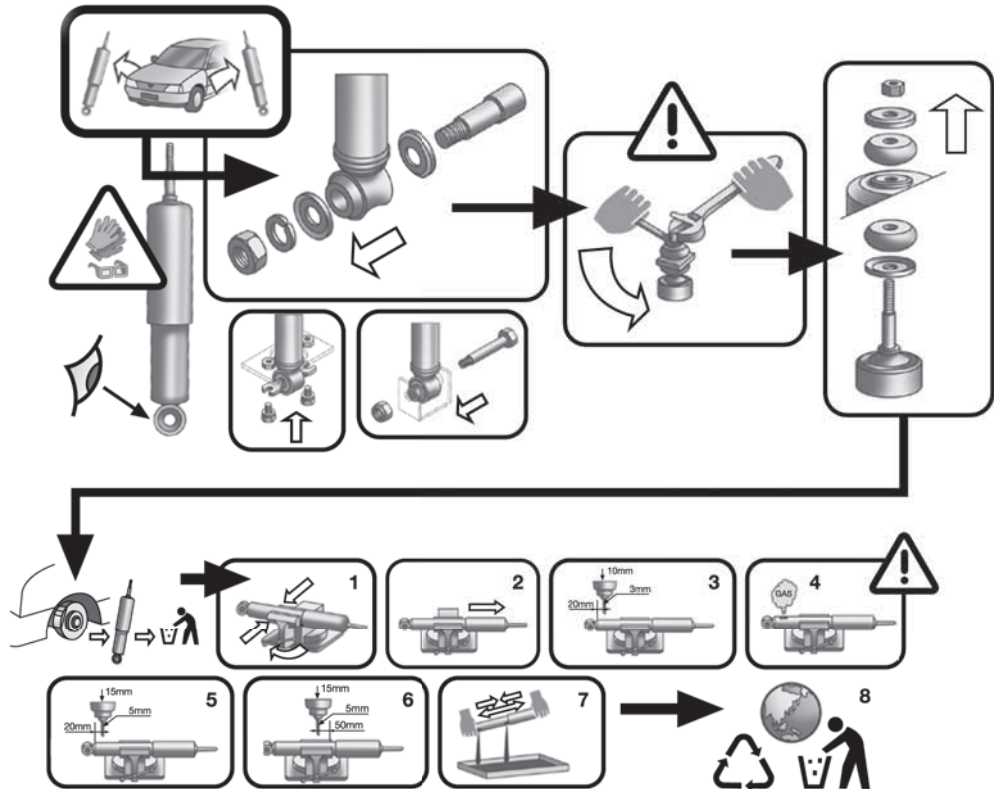

DISPOSAL OF SHOCKS

FITMENT OF SHOCKS

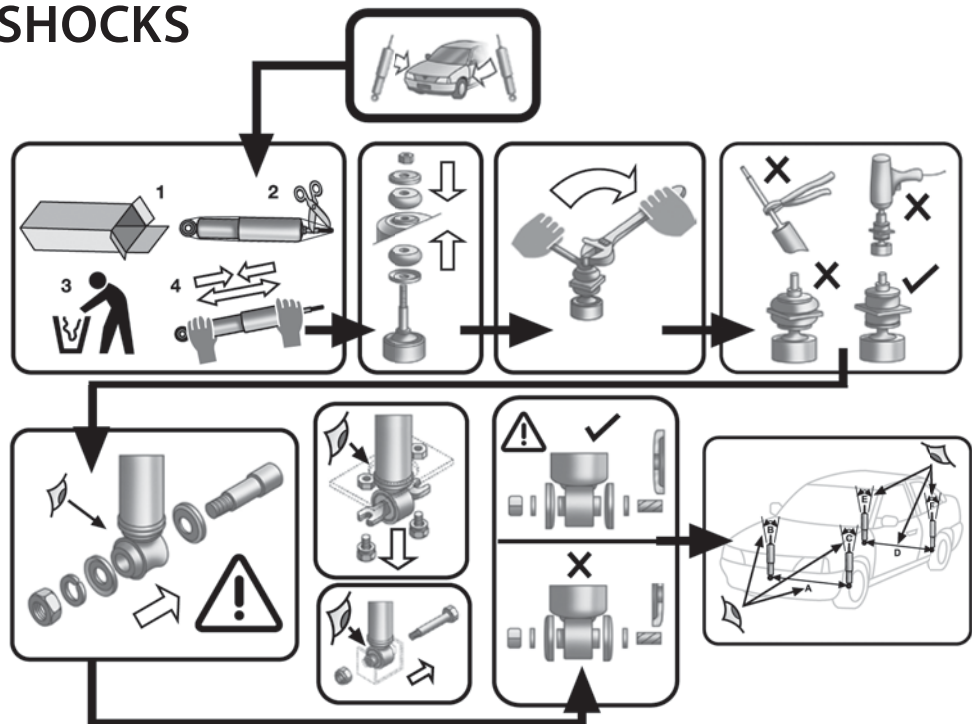

DISCLAIMER: Gabriel cannot be held liable in the event of injury or damage to property during assembly/disassembly/disposal process, if the product is not assembled/disassembled/disposed of at a fitment centre by a trained professional. This is a generic representation, and not all vehicles will have this type of shock configuration.



REMOVAL OF STRUTS

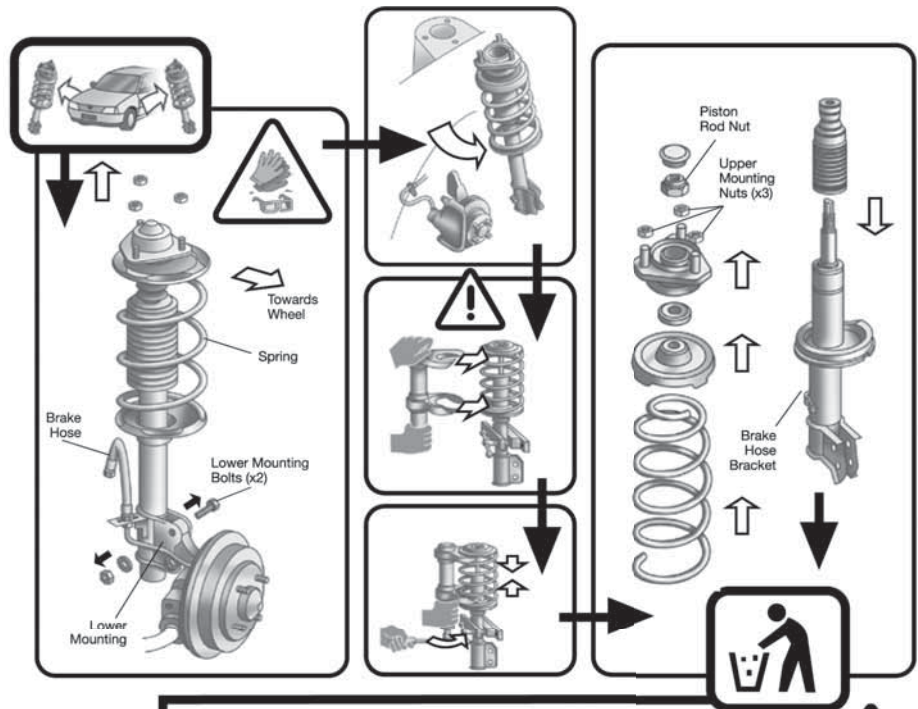

DISPOSAL OF STRUTS

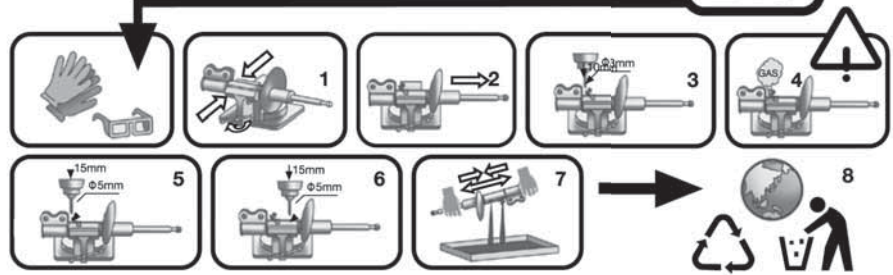

FITMENT OF STRUTS

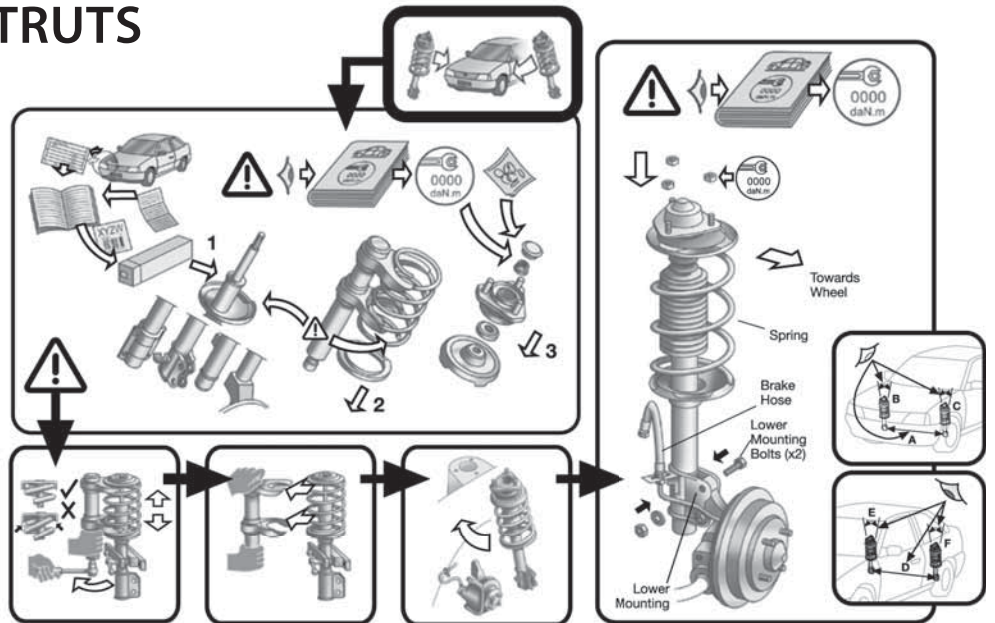

DISCLAIMER: Gabriel cannot be held liable in the event of injury or damage to property during assembly/disassembly/disposal process, if the product is not assembled/disassembled/disposed of at a fitment centre by a trained professional. This is a generic representation, and not all vehicles will have this type of shock configuration.



PARTS LISTING

Collapsed Length	Extended Length	Upper Mounting	Lower Mounting	Accessory Pack Part No.	Shock Type			Part #
					Icon	Fig	Code	
GABRIEL GAS RYDER								
SHOCK ABSORBERS – STUD UPPER, BAR PIN LOWER								
222	335	S	BPx70.0	...	⊥	4	S/BP	61283
235	467	S	BPx75.0	...	⊥	4	S/BP	61243
312	516	S	BPx64.0	...	⊥	4	S/BP	G63721
314	510	S	BPx63.5	...	⊥	4	S/BP	G63424
343	458	S	BPx63.5	...	⊥	4	S/BP	G63678
SHOCK ABSORBERS – STUD UPPER AND LOWER								
243	383	S	S	...	⊥	5	S/S	G63920
262	390	S	S	...	⊥	5	S/S	G63799
287	486	S	S	...	⊥	5	S/S	69742
308	522	S	S	...	⊥	5	S/S	61702
401	560	S	S	...	⊥	5	S/S	69102
406	611	S	S	...	⊥	5	S/S	69654
SHOCK ABSORBERS – STUD UPPER, RUBBER EYE LOWER								
291	474	S	RE16	...	⊕	6.1	S/RE	69069
295	469	S	RE16	...	⊕	6.1	S/RE	G63410
302	477	S	RE16	...	⊕	6.1	S/RE	G63508
333	557	S	RE16	...	⊕	6.1	S/RE	61235
355	601	S	RE16	144070	⊕	6.1	S/RE	61228
358	615	S	RE16	...	⊕	6.1	S/RE	G63940
362	620	S	RE16	...	⊕	6.1	S/RE	62020
371	633	S	RE16	144069	⊕	6.1	S/RE	61212
396	648	S	RE12	...	⊕	6.1	S/RE	62044
396	684	S	RE16	144069	⊕	6.1	S/RE	61230
SHOCK ABSORBERS – STUD UPPER, SLEEVED EYE LOWER								
228	348	S	SE12x32	...	⊕	6.2	S/SE	61287
231	348	S	SE12x34.0	...	⊕	6.2	S/SE	G63933
244	386	S	SE12x38.0	...	⊕	6.2	S/SE	G63935
246	367	S	SE12x32.0	...	⊕	6.2	S/SE	G63612
255	378	S	SE13x38.0	...	⊕	6.2	S/SE	G63414
258	392	S	SE12x32.0	...	⊕	6.2	S/SE	G63737
262	390	S	SE8x58.0	...	⊕	6,2	S/SE	G63799
265	432	S	SE14x41.0	...	⊕	6.2	S/SE	69901
272	439	S	SE10x36.0	...	⊕	6.2	S/SE	61256
286	456	S	SE12x74.0	...	⊕	6,2	S/SE	62082
288	400	S	SE14x44.5	...	⊕	6.2	S/SE	69104
288	468	S	SE11x32.5	144073	⊕	6.2	S/SE	69677
294	473	S	SE12x38.0	...	⊕	6.2	S/SE	G63663



Collapsed Length	Extended Length	Upper Mounting	Lower Mounting	Accessory Pack Part No.	Shock Type			Part #
					Icon	Fig	Code	
GABRIEL GAS RYDER (CONT...)								
SHOCK ABSORBERS – STUD UPPER, SLEEVED EYE LOWER (CONT...)								
297	496	S	SE10x40.0	144152		6.2	S/SE	61241
299	458	S	SE16x36.0	...		6.2	S/SE	G63930
309	551	S	SE10x36.0	...		6.2	S/SE	69891
312	525	S	SE13x53.0	...		6.2	S/SE	69633
313	510	S	SE20x42	...		6.2	S/SE	61288
315	502	S	SE10x40.0	144151		6.2	S/SE	61254
315	505	S	SE10x40.0	144153		6.2	S/SE	69744
321	486	S	SE11x56.0	...		6.2	S/SE	69664
324	543	S	SE	...		6.2	S/SE	69948
325	537	S	SE12x32.0	...		6.2	S/SE	69674
326	514	S	SE10x40.0	...		6.2	S/SE	61296
326	553	S	SE10x36.0	...		6.2	S/SE	61242
327	543	S	SE13x32.0	...		6.2	S/SE	G63720
331	551	S	SE12x32.0	...		6.2	S/SE	61233
335	550	S	SE12x40.0	...		6.2	S/SE	61239
339	575	S	SE14x37	...		6.2	S/SE	69507
342	576	S	SE10x36.0	...		6.2	S/SE	61200
348	598	S	SE14x40		6,2	S/SE	62043
351	575	S	SE16	...		6.2	S/SE	G63636
354	567	S	SE12x40.0	...		6.2	S/SE	69989
356	577	S	SE16x58.0	...		6.2	S/SE	G63483
359	535	S	SE12x40.0	...		6.2	S/SE	69425
359	595	S	SE14x37	...		6.2	S/SE	69506
359	608	S	SE14x40		6,2	S/SE	62025
362	608	S	SE 12.2		6.2	S/SE	62022
362	608	S	SE12.2x60	...		6.2	S/SE	61297
363	583	S	SE15.6		6.2	S/SE	62024
363	600	S	SE14x40	...		6.2	S/SE	62001
364	553	S	SE15	...		6.2	S/SE	62003
364	612	S	SE12x38.0	...		6.2	S/SE	G63936
365	471	S	SE15,5x65,5	...		6.2	S/SE	61292
368	617	S	SE12x40.0	...		6.2	S/SE	61248
369	569	S	SE10x40.0	...		6.2	S/SE	61270
370	604	S	SE12x55		6.2	S/SE	62016
372	586	S	SE14x40	...		6.2	S/SE	62002
372	586	S	SE14x40		6,2	S/SE	62018
372	587	S	SE14x40	...		6.2	S/SE	61293
374	569	S	SE10.2x40		6.2	S/SE	62005
374	585	S	SE14.2x36.9		6.2	S/SE	62018



PARTS LISTING

Collapsed Length	Extended Length	Upper Mounting	Lower Mounting	Accessory Pack Part No.	Shock Type			Part #
					Icon	Fig	Code	
GABRIEL GAS RYDER (CONT...)								
SHOCK ABSORBERS – STUD UPPER, SLEEVED EYE LOWER (CONT...)								
375	532	S	SE10x40.0	144151		6.2	S/SE	61253
375	538	S	SE12x40	...		6.2	S/SE	62006
375	605	S	SE	...		6.2	S/SE	69942
375	605	S	SE10	...		6.2	S/SE	69946
381	565	S	SE12x55	...		6.2	S/SE	62000
385	603	S	SE15.6	...		6.2	S/SE	61298
386	646	S	SE12x55	...		6.2	S/SE	61286
388	673	S	SE	...		6.2	S/SE	69460
389	595	S	SE16x38	...		6.2	S/SE	61289
390	470	S	SE10x40.0	...		6.2	S/SE	69957
393	588	S	SE12x60.0	...		6.2	S/SE	69926
394	656	S	SE10x45.0	Nut 413049		6.2	S/SE	61262
396	648	S	SE12x52		6,2	S/SE	62044
397	634	S	SE12x55	...		6.2	S/SE	61285
398	659	S	SE16x40		6,2	S/SE	62060
399	610	S	SE12x35.0	...		6.2	S/SE	69422
400	585	S	SE10x48	144303		6,2	S/SE	62032
402	492	S	SE10x40	144303		6,2	S/SE	62030
403	588	S	SE12x60.0	...		6.2	S/SE	69940
406	583	S	SE10x48	144303		6,2	S/SE	62013
411	468	S	SE	...		6.2	S/SE	69928
411	637	S	SE10x41.0	...		6.2	S/SE	69964
413	673	S	SE22x40		6,2	S/SE	62061
414	536	S	SE10x41.0	...		6.2	S/SE	G63914
416	529	S	SE10x41.0	...		6.2	S/SE	69723
425	672	S	SE12x40		6.2	S/SE	62009
432	672	S	SE12x45.5	...		6.2	S/SE	61299
437	557	S	SE12x39.5		6.2	S/SE	62011
437	665	S	SE14x37		6,2	S/SE	62057
440	604	S	SE 12x43		6.2	S/SE	62021
446	473	S	SE10x40.0	...		6.2	S/SE	69956
465	569	S	SE10x40		6.2	S/SE	62004
467	545	S	SE10x40.0	...		6.2	S/SE	69952
467	545	S	SE10x40.0	...		6.2	S/SE	69966
467	566	S	SE10	...		6.2	S/SE	69953
469	700	S	SE12x36		6.2	S/SE	62023
481	624	S	SE15.5x40		6.2	S/SE	62012



Collapsed Length	Extended Length	Upper Mounting	Lower Mounting	Accessory Pack Part No.	Shock Type			Part #
					Icon	Fig	Code	
GABRIEL GAS RYDER (CONT...)								
SHOCK ABSORBERS – STUD UPPER, U-BRACKET LOWER (CONT...)								
389	470	S	B	...			S/B	62035
382	572	S	B			S/B	62036
SHOCK ABSORBERS – STUD UPPER, SPECIAL MOUNTING LOWER								
283	462	S	SM	144014		7.1	S/SM	61202
353	483	S	SM	144014		7.1	S/SM	61201
SHOCK ABSORBERS – RUBBER EYE UPPER, SLEEVED EYE LOWER								
339	537	RE16	SE13x35.0	...		8.3	RE/SE	G63683
339	550	RE16	SE12x38.0	...		8.3	RE/SE	G63626
383	643	RE16	SE12x38.0	...		8.3	RE/SE	G63461
SHOCK ABSORBERS – SLEEVED EYE UPPER, RUBBER EYE LOWER								
271	386	SE10x34	RE16	...		8.4	SE/RE	69938
318	490	SE14x40	RE19x40	144031		8.4	SE/RE	EG63659
SHOCK ABSORBERS – SLEEVED EYE UPPER AND LOWER								
205	339	SE10x38.0	SE10x38.0	...		8.5	SE/SE	69921
219	323	SE10x38.0	SE12x35.0	...		8.5	SE/SE	69934
219	323	SE10	SE12	...		8.5	SE/SE	69935
224	321	SE10x38.0	SE12x36.0	...		8.5	SE/SE	69919
240	333	SE12x40.0	SE14x40.0	...		8.5	SE/SE	69965
255	405	SE12	SE12	...		8.5	SE/SE	69769
256	392	SE12x48.0	SE14x40.0	...		8.5	SE/SE	69986
258	397	SE12x32.0	SE12x32.0	...		8.5	SE/SE	69431
259	373	SE12x48	SE12x40	...		8.5	SE/SE	61284
259	370	SE14x40	SE14x40		8,5	SE/SE	62086
260	360	SE12x40	SE14x62	...		8.5	SE/SE	69446
260	365	SE12x40.0	SE14x62.0	...		8.5	SE/SE	69401
261	401	SE12x48.0	SE14x40.0	...		8.5	SE/SE	69415
261	403	SE12x32.0	SE12x32		8,5	SE/SE	62037
262	383	SE12x35.0	SE12x36.0	...		8.5	SE/SE	69412
268	403	SE12x60.0	SE12x32.0	...		8.5	SE/SE	69689
269	416	SE12x48.0	SE14x40.0	...		8.5	SE/SE	69987
270	385	SE12x46.0	SE12x46.0	...		8.5	SE/SE	69914
271	421	SE12.4x48	SE14.2x40		8.5	SE/SE	62019
271	422	SE12x42.0	SE12x48.0	...		8.5	SE/SE	69616
272	418	SE13x42.5	SE13x42.5	...		8.5	SE/SE	G63423
283	449	SE12x32.0	SE12x32		8,5	SE/SE	62089
289	456	SE10x36.0	SE10x36.0	...		8.5	SE/SE	61257



PARTS LISTING

Collapsed Length	Extended Length	Upper Mounting	Lower Mounting	Accessory Pack Part No.	Shock Type			Part #
					Icon	Fig	Code	
GABRIEL GAS RYDER (CONT...)								
SHOCK ABSORBERS – SLEEVED EYE UPPER AND LOWER (CONT...)								
290	433	SE12.2x44	SE12.2x44	...	☉	8.5	SE/SE	62014
291	457	SE12x42.0	SE12x42.0	...	☉	8.5	SE/SE	G63690
309	449	SE12x55.0	SE14x41.0	...	☉	8.5	SE/SE	69922
309	495	SE12x32.0	SE12x36.0	...	☉	8,5	SE/SE	62038
310	509	SE10x32.0	SE12x32.0	...	☉	8.5	SE/SE	61214
311	473	SE12x40.0	SE12x40.0	...	☉	8.5	SE/SE	62007
313	343	SE10	SE12	...	☉	8.5	SE/SE	69444
318	503	SE14x39.5	SE14x39.0	...	☉	8.5	SE/SE	G63738
320	413	SE12x42.0	SE14x35.0	...	☉	8.5	SE/SE	69760
321	471	SE14x40	SE12x40	...	☉	8.5	SE/SE	62010
323	508	SE12.5x65	SE12.3x44.5	...	☉	8.5	SE/SE	62033
326	477	SE12.5x65	SE12.3x44.5	...	☉	8.5	SE/SE	62026
330	472	SE10x55	SE12x48.0	...	☉	8,5	SE/SE	62046
330	519	SE14x40.0	SE14x40.0	...	☉	8.5	SE/SE	62008
339	526	SE12x40.0	SE14x39.5	...	☉	8.5	SE/SE	69924
346	570	SE12x28	SE12x32	...	☉	8,5	SE/SE	62040
362	497	SE14x40	SE14x40	...	☉	8.5	SE/SE	61294
380	464	SE14x40.0	SE13x52.0	...	☉	8,5	SE/SE	69932
387	640	SE10x32.0	SE10x51.0	...	☉	8.5	SE/SE	61238
389	470	SE	SE	...	☉	8.5	SE/SE	62035
390	468	SE14.5x59.0	SE12.5x61.0	...	☉	8.5	SE/SE	69928
400	465	SE14.5x34.0	SE14.5x59.0	...	☉	8.5	SE/SE	69927
SHOCK ABSORBERS – SLEEVED EYE UPPER, STUD LOWER								
290	479	SE10x40.0	S	144216	☉	9.2	SE/S	61252
340	563	SE19x39.5	S	...	☉	9.2	SE/S	G63694
381	628	SE16x40.0	S	...	☉	9.2	SE/S	G63482
SHOCK ABSORBERS – SLEEVED EYE UPPER, BAR PIN LOWER								
232	345	SE10x58.0	BPx86.5	...	☉	10	SE/BP	61232
232	345	SE10x75.0	BPx86.5	...	☉	10	SE/BP	61213
SHOCK ABSORBERS – SLEEVED EYE UPPER, SPECIAL MOUNTING LOWER								
234	324	SE10x38.0	SM	...	☉	11	SE/SM	69983
244	355	SE12x46.0	SM	...	☉	11	SE/SM	62053
259	370	SE12x47	SM	...	☉	11	SE/SM	62086
311	479	SE10.3x75	SM	...	☉	11	SE/SM	69538
323	478	SE10.3x75	SM	...	☉	11	SE/SM	69512
SHOCK ABSORBERS – BAR PIN UPPER, RUBBER EYE LOWER								
320	516	BPx79.0	RE16	...	☉	13.1	BP/RE	G63425



Collapsed Length	Extended Length	Upper Mounting	Lower Mounting	Accessory Pack Part No.	Shock Type			Part #
					Icon	Fig	Code	
GABRIEL GAS RYDER (CONT...)								
SHOCK ABSORBERS – BAR PIN UPPER, SLEEVED EYE LOWER								
264	605	BPx73.0	SE14x41.0	...		13.2	BP/SE	G63422
301	482	BPx75.0	SE12x32.0	...		13.2	BP/SE	69423
302	482	BPx75.0	SE12x32.0	...		13.2	BP/SE	69875
311	495	BPx80.0	SE13x35.0	...		13.2	BP/SE	G63722
353	561	BPx76.0	SE12x42		13.2	BP/SE	62015
353	569	BPx76.0	SE12x42	...		13.2	BP/SE	61295
380	762	BPx73.0	SE12x38.0	...		13.2	BP/SE	G63679
GABRIEL® SAFARI™								
SPRING SEAT SHOCK ABSORBERS – STUD UPPER, BAR PIN LOWER								
219	331	S	BPx55.9	144073		4	S/BP	G56104
231	352	S	BPx66.5	144068		4	S/BP	G56185
235	363	S	BPx72.5	144068		4	S/BP	G56178
238	375	S	BPx81	144068		4	S/BP	G56251
SHOCK ABSORBERS – STUD UPPER AND LOWER								
268	441	S	S	144073, 144073		5	S/S	G56119
294	492	S	S	144073, 144073		5	S/S	G56105
303	511	S	S	144073, 144074		5	S/S	G56154
312	483	S	S	144287		5	S/S	G56239
326	552	S	S	144071, 144071		5	S/S	G56164
332	568	S	S	144073, 144074		5	S/S	G56120
340	591	S	S	144071, 144071		5	S/S	G56230
345	590	S	S	144071, 144071		5	S/S	G56180
SHOCK ABSORBERS – STUD UPPER, RUBBER EYE LOWER								
324	535	S	RE20	144068, 144031		6.1	S/RE	G56166
326	537	S	RE20	144282, 144031		6.1	S/RE	46002
328	555	S	RE16	144073		6.1	S/RE	55088
332	555	S	RE20	144068, 144031		6.1	S/RE	G56219
344	582	S	RE20	144071, 144031		6.1	S/RE	G56231
348	581	S	RE20	144071, 144031		6.1	S/RE	G56179
352	599	M10x1.25	RE20	144068, 144031		6.1	S/RE	55238
353	606	S	RE16	144037		6.1	S/RE	55211
375	646	S	RE19.5x44.2	144068, 144031		6,1	S/RE	55243



PARTS LISTING

Collapsed Length	Extended Length	Upper Mounting	Lower Mounting	Accessory Pack Part No.	Shock Type			Part #
					Icon	Fig	Code	
GABRIEL® SAFARI™ (CONT...)								
SHOCK ABSORBERS – STUD UPPER, SLEEVED EYE LOWER								
211	314	S	SE12x32.0	144068		6.2	S/SE	G56171
218	333	S	SE12	144068		6.2	S/SE	G56241
221	333	S	SE12x32.0	144068		6.2	S/SE	G56172
230	350	S	SE12	144069		6.2	S/SE	46004
231	352	S	SE12x32.0	144068		6.2	S/SE	G56176
232	350	S	SE16x38.0	144068		6.2	S/SE	G56189
233	363	S	SE 12	...		6.2	S/SE	G56235
234	359	S	SE12x40.0	144068		6.2	S/SE	G56169
234	365	S	SE 12	144068		6.2	S/SE	G56244
237	371	S	SE12.2x32	144068		6.2	S/SE	G56211
239	364	S	SE12.2x40	...		6.2	S/SE	G56249
240	372	S	SE12x32.0	144068		6.2	S/SE	G56173
240	377	S	SE12x32	...		6.2	S/SE	G56203
241	347	S	SE12x40	...		6.2	S/SE	55231
243	364	S	SE12x40	144068		6.2	S/SE	G56222
252	382	S	SE14x80.0	...		6.2	S/SE	55227
259	416	S	SE12	144068		6.2	S/SE	G56214
272	434	S	SE13x37.5	144074		6.2	S/SE	G56123
272	435	S	SE12x32.0	144068		6.2	S/SE	G56158
297	486	S	SE13x37.5	144021		6.2	S/SE	G56118
300	458	S	SE16	144069		6.2	S/SE	46005
342	578	S	SE14		6.2	S/SE	G56274
348	587	S	SE13x37.5	144021		6.2	S/SE	G56155
354	574	S	SE19x45		6.2	S/SE	G56293
355	578	S	SE19.2	144282		6.2	S/SE	G56227
365	590	S	SE14	...		6.2	S/SE	G56238
428	555	S	SE14x41.0	144071, 144274		6.2	S/SE	G56292
SHOCK ABSORBERS – STUD UPPER, SPECIAL MOUNTING LOWER								
257	417	M14x1.5	SM	...		7.1	S/SM	G56258
SHOCK ABSORBERS – BOLT UPPER, SLEEVED EYE LOWER								
249	379	BT	SE13x35.0	144028		8.1	BT/SE	G56106
250	378	BT	SE13x35.0	144028		8.1	BT/SE	G56106
355	589	BT	SE14.5x42.5	144028		8.1	BT/SE	G56147



Collapsed Length	Extended Length	Upper Mounting	Lower Mounting	Accessory Pack Part No.	Shock Type			Part #
					Icon	Fig	Code	
GABRIEL® SAFARI™ (CONT...)								
SHOCK ABSORBERS – RUBBER EYE UPPER AND LOWER								
278	432	RE20	RE20	144031 144031		8.2	RE/RE	G56112
279	436	RE16	RE16	...		8.2	RE/RE	G56177
281	431	RE20	RE20	144031 144031		8.2	RE/RE	G56112
283	440	RE16	RE20	144031		8.2	RE/RE	G56175
306	482	RE20	RE20	144031		8.2	RE/RE	G56162
307	489	RE31	RE31		8.2	RE/RE	55241
308	489	RE19	RE19	...		8.2	RE/RE	55237
314	505	RE16	RE16	...		8.2	RE/RE	G56102
322	514	RE20	RE20	144031		8.2	RE/RE	G56126
326	533	RE16	RE19	...		8.2	RE/RE	G56245
327	538	RE16	RE16	...		8.2	RE/RE	G56213
330	537	RE16	RE16	...		8.2	RE/RE	G56116
335	551	RE16	RE16	144072		8.2	RE/RE	G56210
336	550	RE16	RE16		8.2	RE/RE	55222
336	550	RE16	RE16	...		8.2	RE/RE	G56186
337	550	RE 19.5x44.2	RE 19.5x44.2	144031		8.2	RE/RE	55240
337	548	RE16	RE20		8.2	RE/RE	G56187
341	561	RE16	RE19	...		8.2	RE/RE	G56209
343	549	RE20	RE20	144242, 144242		8.2	RE/RE	G56208
348	558	RE19	RE19	...		8.2	RE/RE	G56252
349	575	RE16	RE16	...		8.2	RE/RE	G56190
349	582	RE16	RE16	...		8.2	RE/RE	G56215
351	571	RE20	RE20	144031, 144031		8.2	RE/RE	G56167
353	575	RE20	RE20	144242		8.2	RE/RE	G56281
353	575	RE20	RE20	144242, 144242		8.2	RE/RE	G56207
355	588	RE16	RE16	...		8.2	RE/RE	G56103
361	582	RE12.2x43.5	RE12.2x43.5	...		8.2	RE/RE	G56247
365	607	RE16	RE16	...		8.2	RE/RE	G56184
365	611	RE16	RE16	...		8.2	RE/RE	G56250
376	622	RE20	RE20	144031, 144031		8.2	RE/RE	G56174
376	629	RE20x44.2	RE 19.5x44.2		8.2	RE/RE	55239
387	651	RE20x44.2	RE 19.5x44.2	144031		8.2	RE/RE	55242
394	640	RE20	RE20	144031		8.2	RE/RE	G56240
SHOCK ABSORBERS – RUBBER EYE UPPER, SLEEVED EYE LOWER								
317	511	RE16	SE16 x 38		8,3	RE/SE	G56269
346	572	RE16	SE14	...		8.3	RE/SE	G56236
355	588	RE16	SE13x37.5	...		8.3	RE/SE	G56121



PARTS LISTING

Collapsed Length	Extended Length	Upper Mounting	Lower Mounting	Accessory Pack Part No.	Shock Type			Part #
					Icon	Fig	Code	
GABRIEL® SAFARI™ (CONT...)								
SHOCK ABSORBERS – SLEEVED EYE UPPER, RUBBER EYE LOWER								
330	538	SE12x40	RE16	...	☉	8.4	SE/RE	G56204
SHOCK ABSORBERS – SLEEVED EYE UPPER AND LOWER								
262	394	SE 14x46	SE 14x40	...	☉	8.5	SE/SE	G56268
277	427	SE12x48	SE15x40	☉	8,5	SE/SE	G56278
278	429	SE12	SE15x40	...	☉	8.5	SE/SE	G56224
285	448	SE13x57.0	SE13x35.0	...	☉	8.5	SE/SE	G56149
306	478	SE14.1	SE14.1	...	☉	8.5	SE/SE	G56266
317	512	SE13x35.0	SE13x35.0	...	☉	8.5	SE/SE	G56107
327	528	SE12x42.0	SE12x42.0	...	☉	8.5	SE/SE	G56161
341	540	SE20x40	SE16x48	144272	☉	8.5	SE/SE	G56228
351	565	SE12x45.5	SE12x40.0	...	☉	8.5	SE/SE	G56263
354	577	SE20x40.0	SE12x40	144272	☉	8,5	SE/SE	G56291
355	588	SE15x42.0	SE15x42.0	...	☉	8.5	SE/SE	G56148
362	582	SE12x40.0	SE12x40.0	☉	8,5	SE/SE	G56254
363	583	SE12x40.0	SE12x40.0	☉	8,5	SE/SE	G56255
369	600	SE12	SE15	144272	☉	8.5	SE/SE	G56223
369	612	SE20x43.0	SE12x40.0	...	☉	8.5	SE/SE	G56170
373	617	SE20x40	SE12x40	☉	8,5	SE/SE	G56277
373	633	SE14x40.0	SE14x40.0	...	☉	8.5	SE/SE	55210
381	619	SE16x40	SE14x40	...	☉	8.5	SE/SE	55234
386	623	SE16x52	SE16x52	...	☉	8.5	SE/SE	55232
424	705	SE16x40	SE16x40	...	☉	8.5	SE/SE	55233
425	717	SE16x40.0	SE16x40.0	...	☉	8.5	SE/SE	55224
SHOCK ABSORBERS – RUBBER EYE UPPER, STUD LOWER								
290	466	RE20	S	144031	☽	9.1	RE/S	G56113
291	473	RE16	S	144068	☽	9.1	RE/S	G56157
309	504	RE20	S	144031, 144071	☽	9.1	RE/S	G56163
329	549	RE16	S	144068	☽	9.1	RE/S	G56168
SHOCK ABSORBERS – SLEEVED EYE UPPER, STUD LOWER								
300	492	SE12x32.0	S	144073	☽	9.2	SE/S	G56156
300	492	SE14x32.0	S	144073	☽	9.2	SE/S	G56159
335	555	SE19x44.5	S	144031, 144071	☽	9.2	SE/S	G56165
SHOCK ABSORBERS – SLEEVED EYE UPPER, BAR PIN LOWER								
232	344	SE10x58.0	BPx86.5	...	☽	10	SE/BP	G56160
232	344	SE10x75.0	BPx86.5	...	☽	10	SE/BP	G56153
354	584	SE12x45	BP	...	☽	10	SE/BP	G56246



Collapsed Length	Extended Length	Upper Mounting	Lower Mounting	Accessory Pack Part No.	Shock Type			Part #
					Icon	Fig	Code	
GABRIEL® SAFARI HDP™								
SPRING SEAT SHOCK ABSORBERS – STUD UPPER, SLEEVED EYE LOWER								
258	386	S	SE14x40	...	‡	3.2	SS/SE	GS46010
297	427	S	SE14x48	144274	‡	3.2	SS/SE	GS46009
325	470	S	SE14	NUT 413053	‡	3.2	SS/SE	GS46006
340	470	S	SE14	144274 144288	‡	3.2	SS/SE	GS46008
410	573	S	SE14	144071	‡	3.2	SS/SE	GS46007
SPRING SEAT SHOCK ABSORBERS – STUD UPPER, BAR PIN LOWER								
228	351	S	BP	144274 144277	⊥	4	S/BP	GS56234
340	555	S	BP	144274	⊥	4	S/BP	GS56261
SHOCK ABSORBERS – STUD UPPER AND LOWER								
318	538,6	S	S	144274	‡	5	S/S	GS78002
327	553	S	S	144071, 144071	‡	5	S/S	GS78007
359	616	S	S	144071, 144071	‡	5	S/S	GS78011
SHOCK ABSORBERS – STUD UPPER, RUBBER EYE LOWER								
329	539	S	RE19	144282 144274	⊕	6.1	S/RE	GS78015
348	582	S	RE19	144068	⊕	6.1	S/RE	GS78010
368	619	S	RE19	144282	⊕	6.1	S/RE	GS78017
368	620	S	RE19	144071	⊕	6.1	S/RE	GS78012
SHOCK ABSORBERS – STUD UPPER, SLEEVED EYE LOWER								
210	314	S	SE12	144068	⊕	6.2	S/SE	GS56221
228	351	S	SE12	144068	⊕	6.2	S/SE	GS56220
239	372	S	SE12x40	144277 144274	⊕	6.2	S/SE	GS56233
244	380	S	SE16	144068	⊕	6.2	S/SE	GS56232
244	381	S	SE12	144068	⊕	6.2	S/SE	GS56225
244	387	S	SE12.2x32	144277 144274	⊕	6.2	S/SE	GS56264
297	485	S	SE12	144068	⊕	6.2	S/SE	GS78000
303	494	S	SE16	144068	⊕	6.2	S/SE	GS78019
350	575	S	SE14	144068	⊕	6.2	S/SE	GS78020
SHOCK ABSORBERS – RUBBER EYE UPPER AND LOWER								
351	577	RE16	RE16	...	⊕	8.2	RE/RE	GS78018
355	585	RE16	RE16	144274	⊕	8.2	RE/RE	GS78021
359	585	RE19	RE19	...	⊕	8.2	RE/RE	GS78001
361	596	RE16	RE16	...	⊕	8.2	RE/RE	GS78006
365	594	RE19	RE19	...	⊕	8.2	RE/RE	GS78009
380	631	RE16	RE16	144274	⊕	8.2	RE/RE	GS78016
381	626	RE19	RE19	...	⊕	8.2	RE/RE	GS78004
381	639	RE16	RE16	...	⊕	8.2	RE/RE	GS78003
394	653	RE19	RE19	...	⊕	8.2	RE/RE	GS78005
395	657	RE19	RE19	...	⊕	8.2	RE/RE	GS78013



PARTS LISTING

Collapsed Length	Extended Length	Upper Mounting	Lower Mounting	Accessory Pack Part No.	Shock Type			Part #
					Icon	Fig	Code	
GABRIEL® SAFARI™ (CONT...)								
SHOCK ABSORBERS – RUBBER EYE UPPER, SLEEVED EYE LOWER								
350	572	RE16	SE14	144274	☉	8.3	RE/SE	GS56259
SHOCK ABSORBERS – SLEEVED EYE UPPER, RUBBER EYE LOWER								
338	554	SE13.2x40	RE16	144274	☉	8.4	SE/RE	GS56265
SHOCK ABSORBERS – SLEEVED EYE UPPER AND LOWER								
314	501	SE12x32.0	SE12x32.0	☉	8,5	SE/SE	GS56284
359	577	SE12x46	SE 12x37.0	144274	☉	8.5	SE/SE	GS56267
361	587	SE12.2x43.5	SE12.2x43.5	144274	☉	8.5	SE/SE	GS78030
381	632	SE12x40	SE12x40	144274	☉	8.5	SE/SE	GS78014
382	627	SE20x40	SE12x40	144274, 144272	☉	8,5	SE/SE	GS78032
SHOCK ABSORBERS – RUBBER EYE UPPER, STUD LOWER								
344	563	RE19	S	...	☉	9.1	RE/S	GS78008
SHOCK ABSORBERS –SLEEVED EYE UPPER, BAR PIN LOWER								
360	586	SE	BP	144274	☉	10	SE/BP	GS78029
SHOCK ABSORBERS –BAR PIN UPPER, SLEEVED EYE LOWER								
338	553	BP	SE12x37	144274		13	BP/SE	GS78026
373	617	BP	SE13x40	144274		13	BP/SE	GS56289
GABRIEL® TECHNOMATIC™								
SHOCK ABSORBERS – STUD UPPER, BAR PIN LOWER								
213	326	S	BPx58.5	144069	⊥	4	S/BP	G45532
219	339	S	BPx49.0	144070	⊥	4	S/BP	G45523
219	339	S	BPx56.0	144076	⊥	4	S/BP	G45212
226	352	S	BPx58.5	144070	⊥	4	S/BP	G45398
226	352	S	BPx60.5	144070	⊥	4	S/BP	G45466
228	357	S	BPx66.5	144070	⊥	4	S/BP	36859
232	364	S	BPx72.5	144070	⊥	4	S/BP	G45862
238	377	S	BPx60.5	144076	⊥	4	S/BP	G45876
241	383	S	BPx58.5	144070	⊥	4	S/BP	G45255
258	403	S	BPx75.0	144138	⊥	4	S/BP	G45858
266	430	S	BPx85.0	144078	⊥	4	S/BP	G45651
267	424	S	BPx60.5	144069	⊥	4	S/BP	19289
270	441	S	BPx67.0	144070	⊥	4	S/BP	G45666



Collapsed Length	Extended Length	Upper Mounting	Lower Mounting	Accessory Pack Part No.	Shock Type			Part #
					Icon	Fig	Code	
GABRIEL® TECHNOMATIC™ (CONT...)								
SHOCK ABSORBERS – STUD UPPER AND LOWER								
214	340	S	S	144070	†	5	S/S	G45001
290	493	S	S	144070, 144070	†	5	S/S	G45078
316	544	S	S	144070, 144070	†	5	S/S	G45258
328	556	S	S	144070, 144070	†	5	S/S	G45667
402	598	S	S	144077	†	5	S/S	36764
SHOCK ABSORBERS – STUD UPPER, RUBBER EYE LOWER								
263	424	S	RE16	144070	⊕	6.1	S/RE	G45122
209	316	S	SE12x32.0	144068	⊕	6.2	S/SE	G45842
212	322	S	SE12x32.0	144070	⊕	6.2	S/SE	G45844
213	314	S	SE10x53.0	144070	⊕	6.2	S/SE	45410
218	335	S	SE12x32.0	144070	⊕	6.2	S/SE	G45869
219	334	S	SE12x32.0	144068	⊕	6.2	S/SE	G45893
228	354	S	SE12x32.0	144070	⊕	6.2	S/SE	G45535
228	358	S	SE 12x32	...	⊕	6.2	S/SE	G45885
232	367	S	SE10x24.0	144029	⊕	6.2	S/SE	19022
237	373	S	SE12x32.0	144070	⊕	6.2	S/SE	G45871
244	378	S	SE12x32	...	⊕	6.2	S/SE	61282
246	392	S	SE12x32	144068	⊕	6.2	S/SE	36868
259	404	S	SE12x59.5	144070	⊕	6.2	S/SE	G45459
272	430	S	SE12x74.0	144023	⊕	6.2	S/SE	G45450
279	400	S	SE12x32	144076	⊕	6,2	S/SE	G45901
286	338	S	SE10x32.0	144075	⊕	6.2	S/SE	36850
291	481	S	RE16	144069	⊕	6.1	S/RE	G45469
291	481	S	SE12x32.0	144069	⊕	6.2	S/SE	G45861
294	487	S	SE13x33.0	144021	⊕	6.2	S/SE	G45742
297	493	S	RE16	144069	⊕	6.1	S/RE	G45533
304	506	S	RE16	144070	⊕	6.1	S/RE	G45399
310	519	S	RE16	144070	⊕	6.1	S/RE	G45138
320	452	S	SE12x66.0	...	⊕	6.2	S/SE	36844
324	545	S	RE16	144015	⊕	6.1	S/RE	36761
326	534	S	RE19.5x44	"144031, 144288				
"	2	6.1	S/RE	36872				
326	551	S	SE12x32.0	144069	⊕	6.2	S/SE	G45859
329	554	S	SE12x32.0	144078	⊕	6.2	S/SE	G45838
332	563	S	RE16	144070	⊕	6.1	S/RE	G45841
335	554	S	SE12x40.0	...	⊕	6.2	S/SE	36857
339	576	S	SE10x36.0	144069	⊕	6.2	S/SE	G45839
339	576	S	SE10x36.0	...	⊕	6.2	S/SE	G45874



PARTS LISTING

Collapsed Length	Extended Length	Upper Mounting	Lower Mounting	Accessory Pack Part No.	Shock Type			Part #
					Icon	Fig	Code	
GABRIEL® TECHNOMATIC™ (CONT...)								
SHOCK ABSORBERS – STUD UPPER, RUBBER EYE LOWER (CONT...)								
340	579	S	RE16	...		6.1	S/RE	G45908
343	516	S	SE12x32.0	144070		6.2	S/SE	36767
345	576	S	RE16	144076		6.1	S/RE	G45423
345	493	S	SE12x66.0	...		6.2	S/SE	36826
351	601	S	RE16	144070		6.1	S/RE	G45813
354	588	S	RE16	144076		6.1	S/RE	36876
362	617	S	RE16	144076		6.1	S/RE	36865
363	597	S	SE10x51	...		6.2	S/SE	36866
367	633	S	SE10x36.0	144069		6.2	S/SE	G45489
368	528	S	SE12x32.0	144065		6.2	S/SE	36854
369	562	S	SE10x36.0	...		6.2	S/SE	G45897
370	620	S	SE10	...		6.2	S/SE	G45890
371	541	S	SE13x32.0	...		6.2	S/SE	36748
388	540	S	SE9x38.0	144030		6.2	S/SE	36855
394	631	S	SE10x36	...		6.2	S/SE	G45900
395	631	S	SE10x45.0	...		6.2	S/SE	G45879
404	560	S	SE14x32.0	144075		6.2	S/SE	36851
427	608	S	SE10x50.0	...		6.2	S/SE	36853
433	624	S	SE9x32.0	144030		6.2	S/SE	36849
479	674	S	SE12.2x51	...		6.2	S/SE	G45892
479	709	S	SE12.2x36	...		6.2	S/SE	G45894
SHOCK ABSORBERS – STUD UPPER, SPECIAL MOUNTING LOWER								
317	467	S	SM	...		7.1	S/SM	36847
330	557	S	SM	144014		7.1	S/SM	36760
331	477	S	SM	...		7.1	S/SM	36759
SHOCK ABSORBERS – RUBBER EYE UPPER AND LOWER								
280	441	RE16	RE16	...		8.2	RE/RE	G45054
281	431	RE16	RE20	144031		8.2	RE/RE	G45873
305	499	RE16	RE16	...		8.2	RE/RE	G45909
306	482	RE16	RE16	144031		8.2	RE/RE	G45051
306	498	RE16x36	RE16x36	144245		8.6	RE/RE	36874
314	514	RE16	RE16	...		8.2	RE/RE	61281
322	514	RE16	RE16	144031		8.2	RE/RE	G45006
327	526	RE16	RE16	...		8.2	RE/RE	G45872
336	558	RE16	RE16	...		8.2	RE/RE	G45870
341	549	RE16	RE16	...		8.2	RE/RE	G45905
349	583	RE16	RE16	...		8.2	RE/RE	G45008
379	633	RE20	RE20	144031		8.2	RE/RE	36873
SHOCK ABSORBERS – RUBBER EYE UPPER, SLEEVED EYE LOWER								
295	475	RE16	SE12x32	...		8.3	RE/SE	36869



Collapsed Length	Extended Length	Upper Mounting	Lower Mounting	Accessory Pack Part No.	Shock Type			Part #
					Icon	Fig	Code	
GABRIEL® TECHNOMATIC™ (CONT...)								
SHOCK ABSORBERS – SLEEVED EYE UPPER, RUBBER EYE LOWER								
304	494	SE12x59.5	RE16	...	☉	8.4	SE/RE	G45810
308	504	SE12x40	RE16	...	☉	8.4	SE/RE	G45886
315	517	SE11x65.5	RE16	...	☉	8.4	SE/RE	G45534
318	524	SE12x49.5	RE16	...	☉	8.4	SE/RE	G45538
368	609	SE12x49.5	RE16	...	☉	8.4	SE/RE	G45812
SHOCK ABSORBERS – SLEEVED EYE UPPER AND LOWER								
216	317	SE11x61.5	SE11x32.5	...	☉	8.5	SE/SE	G45447
218	328	SE10x24.0	SE10x24.0	...	☉	8.5	SE/SE	19021
254	393	SE12x32.0	SE12x32.0	...	☉	8.5	SE/SE	18727
254	393	SE12x32.0	SE12x32.0	...	☉	8.5	SE/SE	G45419
256	392	SE12x48.0	SE10x40.0	...	☉	8.5	SE/SE	G45881
260	405	SE12x59.5	SE12x32.0	...	☉	8.5	SE/SE	G45824
261	390	SE12 (Flares to 15)	SE12	...	☉	8.5	SE/SE	36867
263	405	SE12x32.0	SE12x32	☉	8,5	SE/SE	36875
266	418	SE12x32.0	SE12x32.0	144044	☉	8.5	SE/SE	G45417
270	390	SE14x40	SE14x40	...	☉	8.5	SE/SE	42942
279	443	SE10x32.0	SE10x32.0	...	☉	8.5	SE/SE	G45877
283	454	SE12.2X32	SE12.2X32	...	☉	8.5	SE/SE	G45896
284	445	SE16x38.0	SE16x38.0	...	☉	8.5	SE/SE	42772
286	456	SE10x32.0	SE10x58.0	...	☉	8.5	SE/SE	G45715
286	456	SE13x32.0	SE13x32.0	...	☉	8.5	SE/SE	G45413
297	466	SE12x32.0	SE12x32	☉	8,5	SE/SE	G45902
298	482	SE12x30.0	SE12x30.0	...	☉	8.5	SE/SE	G45470
301	488	SE10x32.0	SE10x50.0	...	☉	8.5	SE/SE	G45878
317	520	SE10x32.0	SE12x32.0	...	☉	8.5	SE/SE	G45520
318	502	SE12x32.0	SE12x36.0	...	☉	8.5	SE/SE	G45891
323	524	SE14x40.0	SE12x40.0	...	☉	8.5	SE/SE	42864
327	539	SE12x40	SE12x40	...	☉	8.5	SE/SE	36862
330	545	SE10x32.0	SE10x32.0	...	☉	8.5	SE/SE	G45875
352	589	SE12x32.0	SE12x32.0	...	☉	8.5	SE/SE	G45418
361	586	SE16x38.0	SE16x38.0	...	☉	8.5	SE/SE	42773
363	617	SE14x30.0	SE14x30.0	...	☉	8.5	SE/SE	G45468
366	606	SE16x40	SE16x40	...	☉	8.5	SE/SE	36860
374	621	SE14x40	SE14x40	...	☉	8.5	SE/SE	36863
377	464	SE14x40.0	SE12X49	...	☉	8.5	SE/SE	42826
397	660	SE10x32.0	SE10x51.0	...	☉	8.5	SE/SE	G45860
SHOCK ABSORBERS – RUBBER EYE UPPER, STUD LOWER								
285	468	RE16	S	144068	☉	9.1	RE/S	G45432



PARTS LISTING

Collapsed Length	Extended Length	Upper Mounting	Lower Mounting	Accessory Pack Part No.	Shock Type			Part #
					Icon	Fig	Code	
GABRIEL® TECHNOMATIC™ (CONT...)								
SHOCK ABSORBERS – SLEEVED EYE UPPER, STUD LOWER								
266	430	SE13x32.00	S	...		9.2	SE/S	42447
SHOCK ABSORBERS – SLEEVED EYE UPPER, BAR PIN LOWER								
229	346	SE10x58.0	BPx86.5	...		10	SE/BP	645837
229	346	SE10x75.0	BPx86.5	...		10	SE/BP	645503
SHOCK ABSORBERS – BAR PIN UPPER, SLEEVED EYE LOWER								
285	461	BPx58.5	SE12x25.0	...		13.2	BP/SE	19290
GABRIEL® HEAVY DUTY								
SHOCK ABSORBERS – STUD UPPER, RUBBER EYE LOWER								
318	506	S	RE20	...		6.1	S/RE	83454
SHOCK ABSORBERS – STUD UPPER, SLEEVED EYE LOWER								
201	287	S	SE14x55.0	...		6.2	S/SE	83373
291	439	S	SE20	...		6.2	S/SE	83455
354	564	S	SE19x60.0	...		6.2	S/SE	85319
362	588	S	SE19	...		6.2	S/SE	83456
437	589	S	SE14x35.0	...		6.2	S/SE	82606
SHOCK ABSORBERS – RUBBER EYE UPPER AND LOWER								
415	664	RE25	RE25	...		8.2	RE/RE	85320
SHOCK ABSORBERS – SLEEVED EYE UPPER AND LOWER								
187	238	SE11x35.0	SE11x35.0	...		8.5	SE/SE	83021
291	518	SE14x55.0	SE14x40.0	...		8.5	SE/SE	83450
368	579	SE19x96.5	SE19x81.5	...		8.5	SE/SE	85724
370	583	SE19x60.0	SE19x60.0	...		8.5	SE/SE	85918
SHOCK ABSORBERS – SLEEVED EYE UPPER, STUD LOWER								
223	322	SE12x52.0	S	...		9.2	SE/S	83367
SHOCK ABSORBERS – BAR PIN UPPER, RUBBER EYE LOWER								
337	562	BPx72.9	RE16	...		13.1	BP/RE	81514
GABRIEL® FLEET RYDER®								
SHOCK ABSORBERS – STUD UPPER AND LOWER								
298	486	S	S	144036		5	S/S	76003
311	514	S	S	144036		5	S/S	76041
327	546	S	S		5	S/S	76133
336	565	S	S	144036		5	S/S	76009
349	590	S	S	144036		5	S/S	76020



Collapsed Length	Extended Length	Upper Mounting	Lower Mounting	Accessory Pack Part No.	Shock Type			Part #
					Icon	Fig	Code	
GABRIEL® FLEET RYDER® (CONT...)								
SHOCK ABSORBERS – STUD UPPER AND LOWER (CONT...)								
365	600	S	S	144036, 144036	†	5	S/S	77000
368	628	S	S	†	5	S/S	76006
380	633	S	S	144036, 144036	†	5	S/S	77012
395	682	S	S	144036	†	5	S/S	76206
406	683	S	S	144067, 144067	†	5	S/S	77004
419	730	S	S	144036	†	5	S/S	76034
448	767	S	S	144067, 144067	†	5	S/S	77006
SHOCK ABSORBERS – STUD UPPER, RUBBER EYE LOWER								
334	547	S	RE16	144068	⊕	6.1	S/RE	76132
335	538	S	RE22	144036, 144000	⊕	6.1	S/RE	76043
360	599	S	RE20	144037, 144031	⊕	6.1	S/RE	76102
360	599	S	RE20	⊕	6.1	S/RE	76155
373	614	S	RE22	144036, 144000	⊕	6.1	S/RE	76016
375	617	S	RE20	142095 144000	⊕	6.1	S/RE	76205
381	637	S	RE20	142095 144031	⊕	6.1	S/RE	76204
382	643	S	RE20	⊕	6.1	S/RE	76153
392	652	S	RE25	144067, 144011	⊕	6.1	S/RE	76103
399	646	S	RE22	...	⊕	6.1	S/RE	77011
408	652	S	RE20	144068	⊕	6.1	S/RE	76108
430	729	S	RE25	144067, 144011	⊕	6.1	S/RE	76035
430	729	S	RE25	...	⊕	6.1	S/RE	76112
SHOCK ABSORBERS – STUD UPPER, SLEEVED EYE LOWER								
326	513	S	SE20x46.0	144036	⊕	6.2	S/SE	76151
384	645	S	SE14x40.0	144037	⊕	6.2	S/SE	76037
392	659	S	SE16x48.0	144036	⊕	6.2	S/SE	76131
430	725	S	SE16x50.0	144036	⊕	6.2	S/SE	76156
487	823	S	SE20x62.0	144067	⊕	6.2	S/SE	77001
SHOCK ABSORBERS – RUBBER EYE UPPER AND LOWER								
327	514	RE20	RE20	144031	⊕	8.2	RE/RE	76015
345	546	RE20	RE20	...	⊕	8.2	RE/RE	76135
362	565	RE22	RE22	144011	⊕	8.2	RE/RE	76007
383	612	RE25	RE25	144011	⊕	8.2	RE/RE	76207
384	613	RE22	RE22	144000	⊕	8.2	RE/RE	76042
390	641	RE20	RE20	144031	⊕	8.2	RE/RE	76110
404	610	RE25	RE25	144011	⊕	8.2	RE/RE	77002
435	730	RE20	RE20	144031	⊕	8.2	RE/RE	76100
441	727	RE22	RE22	144000	⊕	8.2	RE/RE	76008



PARTS LISTING

Collapsed Length	Extended Length	Upper Mounting	Lower Mounting	Accessory Pack Part No.	Shock Type			Part #
					Icon	Fig	Code	
GABRIEL® FLEET RYDER® (CONT...)								
SHOCK ABSORBERS – SLEEVED EYE UPPER AND LOWER								
284	343	SE16x38.0	SE16x38	...	☉	8,5	SE/SE	76208
307	448	SE20x55.0	SE20x55.0	...	☉	8.5	SE/SE	77013
310	439	SE24x59.5	SE24x59.5	...	☉	8.5	SE/SE	77020
326	476	SE24x55.0	SE24x55.0	...	☉	8.5	SE/SE	77019
330	515	SE20x46.0	SE20x46.0	...	☉	8.5	SE/SE	76152
346	549	SE16x40.0	SE14x40.0	...	☉	8.5	SE/SE	76039
346	549	SE20x46.0	SE20x46.0	...	☉	8.5	SE/SE	76150
351	567	SE16x38.0	SE16x38	...	☉	8,5	SE/SE	76209
384	626	SE16x40.0	SE14x40.0	...	☉	8.5	SE/SE	76038
396	650	SE20x52.0	SE20x52.0	...	☉	8.5	SE/SE	76017
400	635	SE20x46.0	SE20x46.0	...	☉	8.5	SE/SE	77018
418	660	SE20x55.0	SE20x55.0	...	☉	8.5	SE/SE	76014
429	715	SE16x48.0	SE16x48.0	...	☉	8.5	SE/SE	76021
429	715	SE16x48.0	SE16x48.0	...	☉	8.5	SE/SE	76149
430	695	SE16x48.0	SE16x48.0	...	☉	8.5	SE/SE	77010
430	695	SE16x50.0	SE16x50.0	...	☉	8.5	SE/SE	77003
437	714	SE20x50	SE20x50	...	☉	8.5	SE/SE	76185
442	719	SE20x46.0	SE20x46.0	...	☉	8.5	SE/SE	77022
443	739	SE16x50.0	SE16x50.0	...	☉	8.5	SE/SE	76019
443	739	SE20x55.0	SE20x55.0	...	☉	8.5	SE/SE	76157
463	755	SE20x50	SE20x50	...	☉	8.5	SE/SE	76186
463	784	SE20x46.0	SE20x46.0	...	☉	8.5	SE/SE	76040
466	752	SE16x50.0	SE16x50.0	...	☉	8.5	SE/SE	77005
473	794	SE20x62.0	SE16x63.0	...	☉	8.5	SE/SE	76036
475	785	SE16x50.0	SE16x50.0	...	☉	8.5	SE/SE	77007
475	805	SE16x50.0	SE16x50.0	...	☉	8.5	SE/SE	76033
476	797	SE22x55.0	SE22x55.0	...	☉	8.5	SE/SE	76109
480	801	SE20x62.0	SE20x62.0	...	☉	8.5	SE/SE	76022
519	894	SE16x50.0	SE16x50.0	...	☉	8.5	SE/SE	76106
534	909	SE20x62.0	SE20x62.0	...	☉	8.5	SE/SE	76104
542	903	SE20x62.0	SE20x62.0	...	☉	8.5	SE/SE	77008
SHOCK ABSORBERS – SLEEVED EYE UPPER, STUD LOWER								
345	564	SE20x45.0	S	...	☉	9.2	SE/S	76134
SHOCK ABSORBERS – SLEEVED EYE UPPER, BAR PIN LOWER								
421	653	SE20x62.0	BPx100.0	...	☉	10	SE/BP	77009
472	758	SE20x62.0	BPx100.0	...	☉	10	SE/BP	77023

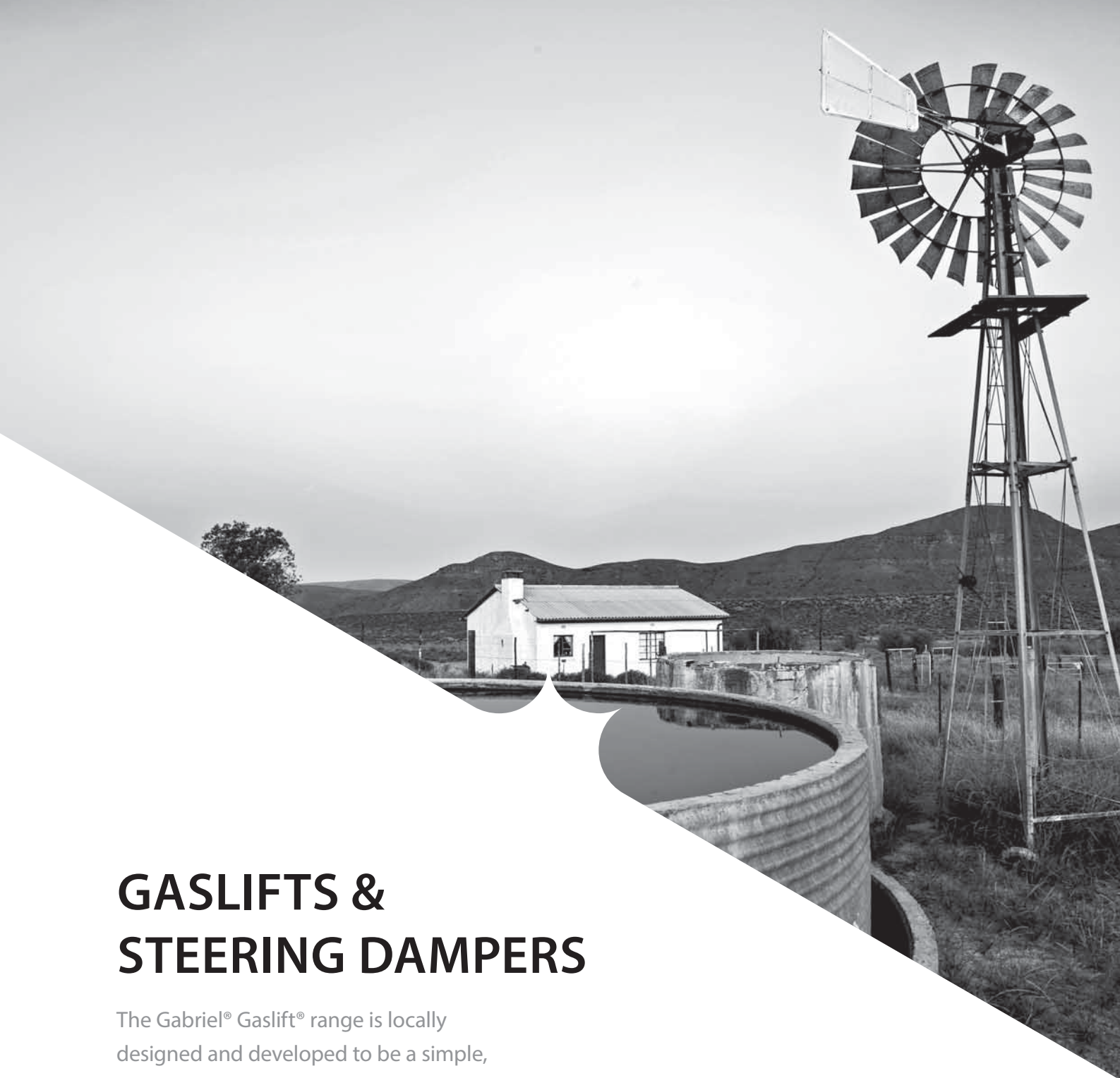

GASLIFTS & STEERING DAMPERS

The Gabriel® Gaslift® range is locally designed and developed to be a simple, hassle free, cost effective and customisable solution, that will allow you to take the lift out of lifting.

Used to open and close various items, the Gabriel® Gaslift® range is used on vehicle bonnets and -boots, doors, canopies, trailers, sunbeds, windows and many more applications.

Available in both an extensive automotive and industrial range, the Gabriels® Gaslift solution via a variety of high quality, long lasting end fittings that will best suite your application and lift angle. Also through our national gas filling solution, you can fill the differing units to the specific pressure that you will need to meet the required weight, angle and application.

Section Content	Page
Product Range and General Information	176
Gas Filling Machine	178
Gaslifts Custom Range	179
Vehicle Listing	180
Parts Listing	182
Parts Finder	185
Technical Information	185
• Universal Gaslifts	185
• Extended & Collapsed Lengths	186
Steering Dampers	191



PRODUCT RANGE

Gabriel® Gaslift®

Takes the lift out of lifting.

The Gabriel® Gaslift® series is designed to be a hassle free and customisable solution to assist in many various applications from, bonnet and boot applications, opening, holding open and closing doors to canopies, sun beds and window solution.

The Gabriel® Gaslift® range is also available in extensive automotive and industrial applications.

The range is supported through a variety of connection end fittings. Further, there is a national gas filling solution to fill units to a specific pressure to meet the required weight, angle and solution.

All of the range is covered by the Gabriel warranty and delivers up to its historical South African pedigree and provides for total peace of mind.



Gabriel® Gaslift®



Gabriel® Gaslift®

Product Features

- Ø16 and Ø19 Bore working cylinder
- Designed to be used to a pressure of up to 1000N (rod size applicable)
- Uses specific oil infused with nitrogen which is designed to work in South African and African climates
- Single lip rod seals
- Sintered metal rod guides
- NBR rod seals
- Gabriel® 12 month warranty

Product Benefits

- A hassle-free ready to use solution for both industrial and automotive requirements
- The industrial range can be customised for particular applications:
 - 4000 Series can be pressurised to 500N
 - 4100 Series can be pressurised to 1000N
- Plastic or metal end fittings to suit specific applications and cost options
- Universal canopy replacements
- Manufactured locally to the highest quality standards using premium quality components

The Gaslift® spring consists of a cylinder, piston and rod assembly able to extend and contract telescopically. The cylinder is filled with nitrogen gas at a very high pressure. It is this gas pressure which creates the lifting ability of the Gaslift® and the force exerted is proportional to the gas pressure.

A measured quantity of oil inside the Gaslift® lubricates the piston assembly and provides damping at the end of the extension movement. The damping imparts a more gentle action to the object being moved. Therefore, the Gaslift® should always be mounted with the rod in a downward position, when the door is fully opened.

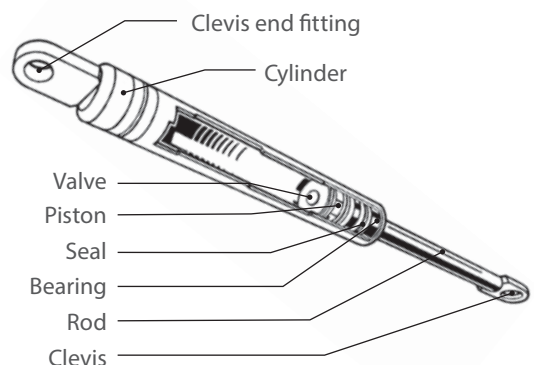



CALCULATING THE FORCE (F1)

Required to hold the lid in the Open position
Refer to the diagram:

- F1 – Force exerted by Gaslift® in Fully Extended Condition
- U – Upper Mounting Point
- L – Lower Mounting Point
- P – Pivot Point
- CG – Centre of Gravity
- A – Horizontal Distance from CG to Pivot Point P
- B – Perpendicular Distance from axis U-L to Pivot Point P
- W – Weight/Mass of lid

If the position of the CG of the lid is not known, then a spring balance or similar can be used to measure the force required to hold the door open. If the force is measured at the upper mounting point U this force plus 10 – 15% safety factor is the F1 required. If the force is measured at any other point, use the perpendicular distance from the pivot point P to the attachment point of the spring balance as A and the spring balance reading as W in the formula.

DIAGRAM OF TYPICAL APPLICATION

(*Refer formula to calculate)

$$* F1 = \frac{W \times A}{B} + 10 \text{ to } 15\% \text{ safety factor}$$

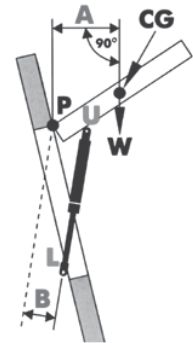

NOTE:

By changing the Gaslift® axis U - L the lid can be made to open automatically once the catch is released, or stay closed so that no catch is required. The calculated force is only enough to balance the mass – add more to keep the flap firmly in place. Work to low side of the calculated pressure at first because additional gas can be added, but pressure cannot be reduced.

GASLIFT APPLICATION (A SELECTION OF EXAMPLES)

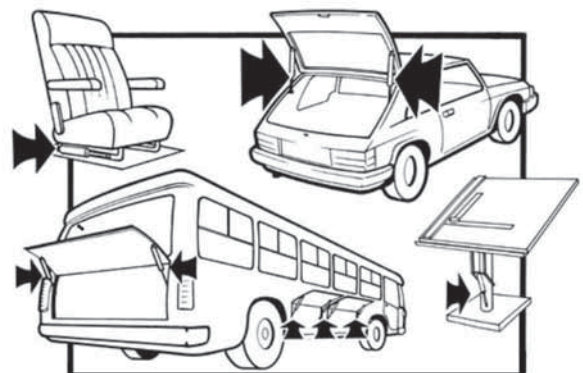
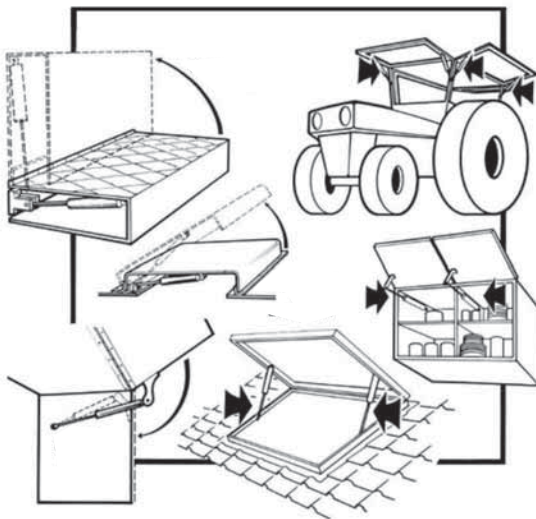



GASLIFTS

Custom Range

GAS FILLING MACHINE

Part #	Model	Derivative
144273	Gas Filling Machine	Gaslifts
144283	Hoses, Fittings & Trigger Valve	Gaslifts
144284	Harris High Pressure Regulator 987-170 Series	Gaslifts
144285	Harris Medium Pressure Regulator 987-100 Series	Gaslifts
144301	19mm gas springs. 8mm rods, 16mm seals	Black seals
144302	22mm gas springs. 10mm rods, 19mm seals	Black seals
S6-9-18306	19mm gas springs. 8mm rods, 16mm seals	Red seals
S6-9-21.5346	22mm gas springs. 10mm rods, 19mm seals	Red seals

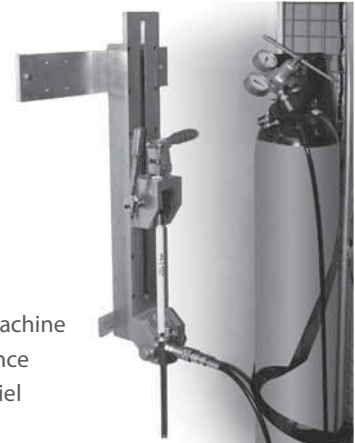

The Gabriel gas filling machine offers you the convenience of pressurizing the Gabriel industrial Gaslift to the application force required.

The gas filling machine may be purchased complete with regulators, hoses and fittings or these accessories may be bought separately.

GASLIFTS

CUSTOM RANGE

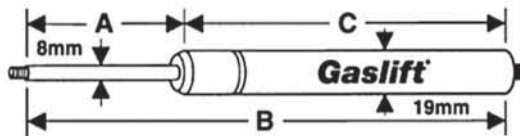

4000 Series 6mm End Fittings*

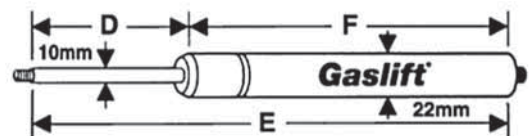
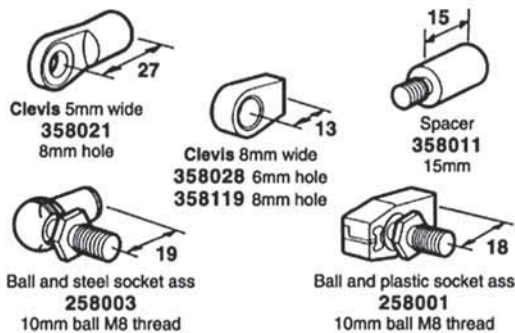

4100 Series 8mm End Fittings*

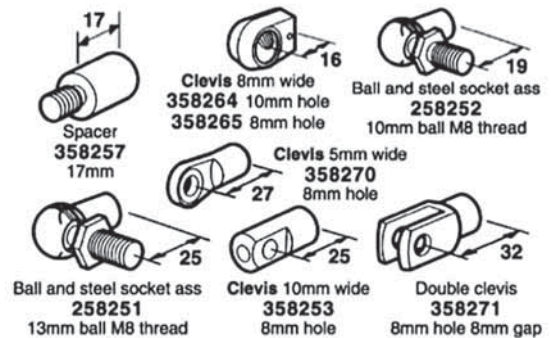



GASLIFTS CUSTOM RANGE

4000 series 6mm End Threads				
Can be pressurised as required up to 500N				
Gas Lift	A	B	C	Force
Part #	Stroke	Ext Length	Coll Length	Newtons
4040	82	200	118	50
4041	107	250	143	50
4042	132	300	168	50
4043	157	350	193	50
4044	182	400	218	50
4045	204	450	246	50
4046	230	500	270	50
4047	257	550	293	50
4048	282	600	318	50
4049	307	650	343	50
4050	332	700	368	50
4051	357	750	393	50
4052	382	800	418	50

4100 series 8mm End Threads				
Can be pressurised as required up to 1000N				
Gas Lift	D	E	F	Nominal Force
Part #	Stroke	Ext Length	Coll Length	Newtons
4140	157	350	193	50
4141	182	400	218	50
4142	207	450	243	50
4143	232	500	268	50
4144	257	550	293	50
4145	282	600	318	50
4146	307	650	343	50
4147	332	700	368	50
4148	357	750	393	50
4149	382	800	418	50
4150	407	850	443	50
4151	432	900	468	50
4152	457	950	493	50
4153	482	1000	518	50
4164	86	209	123	50

4000 series – 8mm Rod			
Required Force (N)	Pressure Settings (kPa)	mPa	Bar
100	1989	2.0	20
150	2983	3.0	30
200	3977	4.0	40
250	4972	5.0	50
300	5966	6.0	60
350	6960	7.0	70
400	7955	8.0	80
450	8949	8.9	89
500	9943	9.9	99

4100 series – 10mm Rod			
Required Force (N)	Pressure Settings (kPa)	mPa	Bar
100	1273	1.3	12.7
150	1909	1.9	19.1
200	2545	2.5	25.5
250	3182	3.2	31.8
300	3818	3.8	38.2
400	5091	5.1	50.9
450	5727	5.7	57.3
500	6364	6.4	63.6
550	7000	7.0	70.0
600	7636	7.6	76.4
650	8273	8.3	82.7
700	8909	8.9	89.1
750	9545	9.5	95.5
800	10182	10.2	101.8
850	10818	10.8	108.2
900	11455	11.5	114.5
950	12091	12.1	120.9
1000	12727	12.7	127.3



Model	Derivative	Vehicle Type	Year	Front	Rear	Side	Status
AUDI							
400, 500	(C3, C4)		83-94	4081			
A4	1.8, 2.4, 2.8 (8D2)		94-01		4284		
BMW							
3 Series	E30 Series, Sedan		83-92	4060			
3 Series (With end-fittings)	E36 Series (excl. M3)		92-99		4269		
3 Series (Without end-fittings)	E36 Series (excl. M3)		92-99		4285		
3 Series	E36 Series (excl. M3)		92-99	4270			
7 Series	E32 Series, Sedan		87-94	4060			
7 Series	E23 Series, Sedan		78-87	4061			
FIAT							
Uno	All Incl. Turbo		90-04		4063		
FORD							
Escort	FWD L, GL, GLE P/C		81-86		4063		
Escort	FWD XR3, Sport		81-86		4064		
Escort	Mk V, Estate		95-99		4272		
Fiesta	All		97-03		4063		
Fiesta	Hatchback		97-03		4063		
Fiesta	Mk V, Tailgate		04-08		4322		
Focus	Mk I		98-04		4316		
Laser, Meteor, Tracer	Sedan		86-01		4087		
Sierra, Sapphire	2300, 2000, 1600, Sedan		83-93		4080		
Sierra, Sapphire	2300, 2000, 1600 Estate		83-93		4080		
Sierra, Sapphire	3000 (Incl. XR6) PC		83-93		4127		
Spectron	Minibus		91-03		4131		
Telstar	Sedan		93-99		4502		
HONDA							
Civic	Hatchback		96-01		4289		
ISUZU							
WFR, Relay	Panel van, Bus		84-95		4129		
LAND ROVER							
Range Rover	Mk I		76-96		4205		
MAZDA							
323	(excl. S, EGi, Sport)		81-91		4071		
323	(S, EGi, Sport)		81-91		4087		
323	(Incl. Midge)		91-04		4087		
626	(Mk II, Mk III)		83-93		4071		
626	Mk IV		92-98		4271		
Marathon	Minibus, Van		91-03		4131		
Soho	Hatchback		97-99		4063		
MERCEDES-BENZ							
A Class	(W168) A160, A190, 170CDi		00-04		4329		



Model	Derivative	Vehicle Type	Year	Front	Rear	Side	Status
NISSAN							
E20	Ekonovan, Ekonowagon		73-95		4162		
Langley, Pulsar	Incl. Panache (N10)		80-83		4099		
Sabre	160,2		92-01		4515	Right	
Sabre	160,2		92-01		4516	Left	
Sentra	140, 160, 200		78-83		4268		
Stanza, Resort	1600J, 1800J		70-81		4068		
OPEL							
Astra	(G)		99-03		4272		
Astra	Estate (F)		94-01		4221		
Chevair, Ascona	(C)		82-86		4080		
Corsa	(B)		96-02		4277		
Corsa	Corsa Lite (B)		02-07		4277		
Corsa	Excl. Corsa Lite (C)		03-07		4308		
Kadett	(Astra)		93-99		4260		
Kadett	Hatchback		80-85		4069		
Kadett	T-car (E)		85-93		4079		
PEUGEOT							
206	Estate		02-on		4333		
306	Estate		98-02		4332		
307	Hatchback		02-on		4331		
504	Estate		74-85		4065		
RENAULT							
Clio	Clio II		00-06		4298		
TOYOTA							
Camry	(XV10), (XV20)		93-01	4165			
Carri	(E90)		98-05		4273		
Condor	MPV Mk IV		00-05		4521	Right	
Condor	MPV Mk IV		00-05		4522	Left	
Conquest, Tazz	FWD (E80)		85-89		4063		
Conquest, Tazz	FWD (E90)		89-05		4273		
Corolla	Estate (E70)		80-85		4207		
Cressida	MX63 (Mk II)		81-93		4083		
Cressida	Mk II Sedan, Wagon		81-93	4084			
Hi-Ace	Super T (Minibus, Van)		69-02		4163		
Venture	(KF40)		91-00		4199		
VOLKSWAGEN							
Citi	All		84 on		4065		
Golf	Mk I,		84 on		4065		
Golf	Mk II		84-92		4082		
Golf	Mk III		93-99		4082		
Golf	Mk IV		99-04		4314		
Golf	Mk V		04-09	4312	4313		
Jetta	Mk III		93-99		4501		
Kombi	Microbus		80-02		4076		
Passat	(B2)		82-87	4067	4068		
Polo	Classic		96-02		4291		



Part #	Range	Product Type	Position	Year	Make	Model	Derivative
4060	Gaslift®	14	Front	83-92	BMW	3 Series	E30 Series, Sedan
			Front	87-94	BMW	7 Series	E32 Series, Sedan
4061	Gaslift®	14	Front	78-87	BMW	7 Series	E23 Series, Sedan
4063	Gaslift®	14	Rear	90-04	Fiat	Uno	All Incl. Turbo
			Rear	81-86	Ford	Escort	FWD L, GL, GLE P/C
			Rear	97-03	Ford	Fiesta	All
			Rear	97-03	Ford	Fiesta	Hatchback
			Rear	97-99	Mazda	Soho	Hatchback
			Rear	85-89	Toyota	Conquest, Tazz	FWD (E80)
4064	Gaslift®	14	Rear	81-86	Ford	Escort	FWD XR3, Sport
4065	Gaslift®	14	Rear	74-85	Peugeot	504	Estate
			Rear	84 on	Volkswagen	Citi	All
			Rear	78-84	Volkswagen	Golf	Mk I,
4067	Gaslift®	14	Front	82-87	Volkswagen	Passat	B2
4068	Gaslift®	14	Rear	78-83	Nissan	Stanza, Resort	1600J, 1800J
			Rear	82-87	Volkswagen	Passat	B2
4069	Gaslift®	14	Rear	80-85	Opel	Kadett	Hatchback
4071	Gaslift®	14	Rear	81-91	Mazda	323	Excl. S, EGi, Sport
			Rear	83-93	Mazda	626	Mk II, Mk III
4076	Gaslift®	14	Rear	80-02	Volkswagen	Kombi	Microbus
4079	Gaslift®	14	Rear	85-93	Opel	Kadett	T-car (E)
4080	Gaslift®	14	Rear	83-93	Ford	Sierra, Sapphire	2300, 2000, 1600, Sedan
			Rear	83-93	Ford	Sierra, Sapphire	2300, 2000, 1600 Estate
			Rear	82-86	Opel	Chevaïr, Ascona	C
4081	Gaslift®	14	Front	83-94	Audi	400, 500	C3, C4
4082	Gaslift®	14	Rear	93-99	Volkswagen	Golf	Mk III
			Rear	84-92	Volkswagen	Golf	Mk II
4083	Gaslift®	14	Rear	81-93	Toyota	Cressida	X30, X32 (Mk I)
4084	Gaslift®	14	Front	81-93	Toyota	Cressida	X35, X36 (Mk I)
4087	Gaslift®	14	Rear	86-01	Ford	Laser, Meteor, Tracer	Sedan
			Rear	81-91	Mazda	323	S, EGi, Sport
			Rear	91-04	Mazda	323	Incl. Midge
4098	Gaslift®	14	Lid	N-A	Venter	Trailer	All
4099	Gaslift®	14	Rear	80-83	Nissan	Langley, Pulsar	Incl. Panache (N10)
4127	Gaslift®	14	Rear	83-93	Ford	Sierra, Sapphire	3000 (Incl. XR6) PC
4129	Gaslift®	14	Rear	84-95	Isuzu	Wfr, Relay	Panel van, Bus
4131	Gaslift®	14	Rear	91-03	Ford	Spectron	Minibus
			Rear	91-03	Mazda	Marathon	Minibus, Van
4162	Gaslift®	14	Rear	73-95	Nissan	E20	Ekonovan, Ekonowagon
4163	Gaslift®	14	Rear	69-02	Toyota	Hi-Ace	Super T (Minibus, Van)
4165	Gaslift®	14	Front	93-01	Toyota	Camry	XV10, XV20



Part #	Range	Product Type	Position	Year	Make	Model	Derivative
4199	Gaslift®	14	Rear	91-00	Toyota	Venture	KF40
4205	Gaslift®	14	Rear	76-96	Land Rover	Range Rover	Mk I
4207	Gaslift®	14	Rear	80-85	Toyota	Corolla	Estate (E70)
4221	Gaslift®	14	Rear	94-01	Opel	Astra	Estate (F)
4260	Gaslift®	14	Rear	93-99	Opel	Kadett	Astra
4268	Gaslift®	14	Rear	92-01	Nissan	Sentra	140, 160, 200
4269	Gaslift®	14	Rear	92-99	Bmw	3 Series	E36 Series (excl. M3)
4270	Gaslift®	14	Front	92-99	Bmw	3 Series	E36 Series (excl. M3)
4271	Gaslift®	14	Rear	92-98	Mazda	626	Mk IV
4272	Gaslift®	14	Rear	95-99	Ford	Escort	Mk V, Estate
			Rear	99-03	Opel	Astra	G
4273	Gaslift®	14	Rear	98-05	Toyota	Carri	E90
			Rear	89-05	Toyota	Conquest, Tazz	FWD (E90)
4277	Gaslift®	14	Rear	96-02	Opel	Corsa	B
			Rear	02-07	Opel	Corsa	Corsa Lite (B)
4284	Gaslift®	14	Rear	96-01	Audi	A4	1.8, 2.4, 2.8 (8D2)
4285	Gaslift®	15	Rear	91-99	Bmw	3 Series	E36 Series
4289	Gaslift®	14	Rear	96-01	Honda	Civic	Hatchback
4291	Gaslift®	14	Rear	96-02	Volkswagen	Polo	Classic
4294	Gaslift®	14	Universal	N-A	Universal	Canopies	& Trailers
4295	Gaslift®	14	Universal	N-A	Universal	Canopies	& Trailers
4296	Gaslift®	14	Universal	N-A	Universal	Canopies	& Trailers
4297	Gaslift®	14	Universal	N-A	Universal	Canopies	& Trailers
4298	Gaslift®	14	Rear	00-06	Renault	Clio	CLIO II
4308	Gaslift®	14	Rear	03-07	Opel	Corsa	Excl. Corsa Lite (C)
4312	Gaslift®	14	Front	04-09	Volkswagen	Golf	Mk V
4313	Gaslift®	14	Rear	04-09	Volkswagen	Golf	Mk V
4314	Gaslift®	14	Rear	99-04	Volkswagen	Golf	Mk IV
4316	Gaslift®	14	Rear	98-04	Ford	Focus	Mk I
4319	Gaslift®	14	Rear	96-03	Renault	Scenic	Mk I (Rear Window)
4322	Gaslift®	14	Rear	04-08	Ford	Fiesta	Mk V, Tailgate
4329	Gaslift®	14	Rear	00-04	Mercedes-Benz	A Class	(W168) A160, A190, 170CDI
4331	Gaslift®	14	Rear	02 on	Peugeot	307	Hatchback
4332	Gaslift®	14	Rear	98-02	Peugeot	306	Estate
4333	Gaslift®	14	Rear	02 on	Peugeot	206	Estate
4501	Gaslift®	14	Rear	93-99	Volkswagen	Jetta	Mk III
4502	Gaslift®	14	Rear	93-99	Ford	Telstar	Sedan
4515	Gaslift®	14	Rear Right	92-01	Nissan	Sabre	160,2
4516	Gaslift®	14	Rear Left	92-01	Nissan	Sabre	160,2
4521	Gaslift®	14	Rear Right	00-05	Toyota	Condor	MPV Mk IV
4522	Gaslift®	14	Rear Left	00-05	Toyota	Condor	MPV Mk IV



Part #	Range	Product Type	Position	Year	Make	Model	Derivative
PACK							SINGLE PART NUMBER
144221	Gaslift®	End Fittings	Top/Bottom	...	Custom	10 of	258251
144222	Gaslift®	End Fittings	Top/Bottom	...	Custom	10 of	358265
144223	Gaslift®	End Fittings	Top/Bottom	...	Custom	10 of	358264
144224	Gaslift®	End Fittings	Top/Bottom	...	Custom	10 of	258252
144225	Gaslift®	End Fittings	Top/Bottom	...	Custom	10 of	358270
144226	Gaslift®	End Fittings	Top/Bottom	...	Custom	10 of	358253
144227	Gaslift®	End Fittings	Top/Bottom	...	Custom	10 of	358271
144228	Gaslift®	End Fittings	Top/Bottom	...	Custom	10 of	358011
144229	Gaslift®	End Fittings	Top/Bottom	...	Custom	10 of	358257
144230	Gaslift®	End Fittings	Top/Bottom	...	Custom	10 of	258001
144231	Gaslift®	End Fittings	Top/Bottom	...	Custom	10 of	358028
144232	Gaslift®	End Fittings	Top/Bottom	...	Custom	10 of	258003
144233	Gaslift®	End Fittings	Top/Bottom	...	Custom	10 of	358021
144234	Gaslift®	End Fittings	Top/Bottom	...	Custom	10 of	358119
SINGLE							
258251	Gaslift®	End Fittings	Top/Bottom	...	Custom	144221	258251 x 10
358265	Gaslift®	End Fittings	Top/Bottom	...	Custom	144222	358265 x 10
358264	Gaslift®	End Fittings	Top/Bottom	...	Custom	144223	358264 x 10
258252	Gaslift®	End Fittings	Top/Bottom	...	Custom	144224	258252 x 10
358270	Gaslift®	End Fittings	Top/Bottom	...	Custom	144225	358270 x 10
358253	Gaslift®	End Fittings	Top/Bottom	...	Custom	144226	358253 x 10
358271	Gaslift®	End Fittings	Top/Bottom	...	Custom	144227	358271 x 10
358011	Gaslift®	End Fittings	Top/Bottom	...	Custom	144228	358011 x 10
358257	Gaslift®	End Fittings	Top/Bottom	...	Custom	144229	358257 x 10
258001	Gaslift®	End Fittings	Top/Bottom	...	Custom	144230	258001 x 10
358028	Gaslift®	End Fittings	Top/Bottom	...	Custom	144231	358028 x 10
258003	Gaslift®	End Fittings	Top/Bottom	...	Custom	144232	258003 x 10
358021	Gaslift®	End Fittings	Top/Bottom	...	Custom	144233	358021 x 10
358119	Gaslift®	End Fittings	Top/Bottom	...	Custom	144234	358119 x 10



PARTS FINDER

Manufacturer Part #	Manufacturer	Gabriel® Gaslift®
ML1653	Monroe	4308
ML1881	Monroe	4079
ML2029	Monroe	4272
ML2173	Monroe	4330
ML2231	Monroe	4289
ML2417	Monroe	4325
ML2477	Monroe	4065
ML2489	Monroe	4314
ML2670	Monroe	4329

Manufacturer Part #	Manufacturer	Gabriel® Gaslift®
ML2800	Monroe	4316
ML2841	Monroe	4327
ML2989	Monroe	4316
ML3007	Monroe	4331
ML3095	Monroe	4313
ML3397	Monroe	4298
ML3657	Monroe	4270
ML4149	Monroe	4284
ML4257	Monroe	4060

TECHNICAL INFORMATION

UNIVERSAL GASLIFTS – REPLACEMENT FOR CANOPIES AND TRAILERS

Part # 4294 – at standard force 250N replaces		
4045-104	4045-105	4045-106
4074-104	4074-105	4074-106
4075-104	4075-105	4075-106
4085-104	4085-105	4085-106
Part # 4295 – at standard force 250N replaces		
4023-104	4023-105	4023-106
4035-104	4035-105	4035-106
4043-104	4043-105	4043-106
4283-104	4283-105	4283-106
Part # 4296 – at standard force 350N replaces		
4045-106	4045-107	4045-108
4072-106	4072-107	4072-108
4074-106	4074-107	4074-108
4075-106	4075-107	4075-108
4085-106	4085-107	4085-108
Part # 4297 – at standard force 350N replaces		
4023-107	4023-108	
4035-107	4035-108	
4043-107	4043-108	



GASLIFTS

SORTED BY COLLAPSED AND EXTENDED LENGTHS

Collapsed Length	Extended Length	Body End	Rod End	Stroke	Force in Newtons	Part #
118	200	None	None	82	50	4040
123	209	None	None	86	50	4164
143	250	None	None	107	50	4041
150	227	Clevis	Clevis	77	470	4268
163	258	Clevis	Clevis	95	350	4060
168	258	M6 Stud	M6 Stud	90	480	4285
168	300	None	None	132	50	4042
170	256	Socket	Socket	86	700	4501
181	288	Clevis	Socket	107	500	4284
181	288	Ball Stud	Ball Stud	107	300	4291
193	350	None	None	157	50	4043
193	350	None	None	157	50	4140
206	296	Socket	Socket	90	480	4269
215	353	Clevis	Clevis	138	320	4270
218	400	None	None	182	50	4044
218	400	None	None	182	50	4141
231	388	Ball & Socket Assembly	Ball & Socket Assembly	158	250	4295
231	388	Ball & Socket Assembly	Ball & Socket Assembly	158	350	4297
232	380	Ball Stud	Socket	148	360	4084
240	365	Bracket	Ball/Socket	125	450	4165
243	450	None	None	207	50	4142
244	404	Socket	Socket	160	390	4323
246	450	None	None	204	50	4045
253	388	Ball Stud	Ball Stud	135	350	4298
267	450	Socket	Socket	183	550	4313
268	500	None	None	232	50	4143
270	500	None	None	230	50	4046
272	469	Clevis	Clevis	197	320	4081
274	472	Socket	Socket	198	330	4308
281	488	Ball Stud	Ball Stud	207	750	4127
282	458	Socket	Socket	176	430	4331
282	486	Socket	Socket	204	510	4080
282	486	Ball Stud	Ball Stud	204	250	4205
283	487	Plastic Socket	Metal Socket	205	170	4098
284	488	Ball & Socket Assembly	Ball & Socket Assembly	205	250	4294
284	488	Ball & Socket Assembly	Ball & Socket Assembly	205	350	4296
285	493	Bracket	Ball Stud	208	800	4502
287	497	Ball Stud	Ball Stud	210	150	4271
289	477	Socket	Socket	188	360	4328
289	485	Socket	Socket	196	530	4316
290	496	Socket	Socket	206	500	4314
290	500	Socket	Socket	210	270	4082
291	460	Socket	Socket	169	100	4319
291	500	Clevis	Clevis	209	510	4065
293	550	None	None	257	50	4047
293	550	None	None	257	50	4144



GASLIFTS

SORTED BY COLLAPSED AND EXTENDED LENGTHS (CONT...)

Collapsed Length	Extended Length	Body End	Rod End	Stroke	Force in Newtons	Part #
295	500	Socket	Socket	205	420	4325
295	513	Clevis	Socket	218	560	4076
300	500	Socket	Socket	200	690	4326
300	510	Socket	Socket	210	340	4330
302	500	Clevis	Clevis	198	230	4061
304	514	Ball Stud	Ball Stud	210	550	4221
307	525	Socket	Clevis	218	600	4515
307	525	Socket	Clevis	218	600	4516
310	520	Socket	Socket	210	570	4327
315	525	Socket	Socket	210	140	4333
317	551	Socket	Socket	234	450	4079
318	600	None	None	282	50	4048
318	600	None	None	282	50	4145
322	532	Socket	Socket	210	400	4272
324	549	Clevis	Clevis	225	350	4068
332	543	Socket	Socket	211	340	4277
340	540	Socket	Socket	200	400	4329
343	650	None	None	307	50	4049
343	650	None	None	307	50	4146
345	595	Socket	Socket	250	515	4320
346	597	Socket	Socket	251	350	4260
351	577	Socket	Socket	226	325	4063
351	577	Socket	Socket	226	405	4064
353	578	Bracket	Bracket	225	300	4273
356	638	Ball Stud	Ball Stud	282	400	4207
362	572	Clevis	Clevis	210	250	4099
364	624	Socket	Socket	260	340	4332
368	700	None	None	332	50	4050
368	700	None	None	332	50	4147
372	625	Socket	Socket	253	575	4322
374	625	Clevis	Socket	251	300	4289
386	702	Clevis	Clevis	316	240	4067
393	750	None	None	357	50	4051
393	750	None	None	357	50	4148
397	662	Bracket	Ball Stud	265	500	4162
404	735	Socket	Socket	332	340	4069
407	723	Socket	Socket	316	250	4312
416	722	Socket	Socket	306	280	4324
417	699	Socket	Socket	282	350	4071
418	800	None	None	382	50	4052
418	800	None	None	382	50	4149
442.5	800	Ball Stud	Ball Stud		800	4129
443	669	Socket	Socket	226	390	4087
443	850	None	None	407	50	4150
448	673	Socket	Socket	225	460	4083



GASLIFTS

SORTED BY COLLAPSED AND EXTENDED LENGTHS (CONT...)

Collapsed Length	Extended Length	Body End	Rod End	Stroke	Force in Newtons	Part #
468	900	None	None	432	50	4151
492	713	Clevis	Clevis	221	600	4521
492	713	Clevis	Clevis	221	600	4522
493	950	None	None	457	50	4152
508	700	Clevis	Clevis	192	825	4163
518	1000	None	None	482	50	4153
520	843	Ball Stud	Clevis	323	675	4131
525	777	Socket	Bracket	252	550	4199

GASLIFTS

SORTED BY PART NUMBERS

Part #	Collapsed Length	Extended Length	Body End	Rod End	Stroke	Force in Newtons
4040	118	200	None	None	82	50
4041	143	250	None	None	107	50
4042	168	300	None	None	132	50
4043	193	350	None	None	157	50
4044	218	400	None	None	182	50
4045	246	450	None	None	204	50
4046	270	500	None	None	230	50
4047	293	550	None	None	257	50
4048	318	600	None	None	282	50
4049	343	650	None	None	307	50
4050	368	700	None	None	332	50
4051	393	750	None	None	357	50
4052	418	800	None	None	382	50
4060	163	258	Clevis	Clevis	95	350
4061	302	500	Clevis	Clevis	198	230
4063	351	577	Socket	Socket	226	325
4064	351	577	Socket	Socket	226	405
4065	291	500	Clevis	Clevis	209	510
4067	386	702	Clevis	Clevis	316	240
4068	324	549	Clevis	Clevis	225	350
4069	404	735	Socket	Socket	332	340
4071	417	699	Socket	Socket	282	350
4076	295	513	Clevis	Socket	218	560
4079	317	551	Socket	Socket	234	450
4080	282	486	Socket	Socket	204	510
4081	272	469	Clevis	Clevis	197	320
4082	290	500	Socket	Socket	210	270
4083	448	673	Socket	Socket	225	460
4084	232	380	Ball Stud	Socket	148	360
4087	443	669	Socket	Socket	226	390



Part #	Collapsed Length	Extended Length	Body End	Rod End	Stroke	Force in Newtons
4098	283	487	Plastic Socket	Metal Socket	205	170
4099	362	572	Clevis	Clevis	210	250
4127	281	488	Ball Stud	Ball Stud	207	750
4129	442.5	800	Ball Stud	Ball Stud		800
4131	520	843	Ball Stud	Clevis	323	675
4140	193	350	None	None	157	50
4141	218	400	None	None	182	50
4142	243	450	None	None	207	50
4143	268	500	None	None	232	50
4144	293	550	None	None	257	50
4145	318	600	None	None	282	50
4146	343	650	None	None	307	50
4147	368	700	None	None	332	50
4148	393	750	None	None	357	50
4149	418	800	None	None	382	50
4150	443	850	None	None	407	50
4151	468	900	None	None	432	50
4152	493	950	None	None	457	50
4153	518	1000	None	None	482	50
4162	397	662	Bracket	Ball Stud	265	500
4163	508	700	Clevis	Clevis	192	825
4164	123	209	None	None	86	50
4165	240	365	Bracket	Ball/Socket	125	450
4199	525	777	Socket	Bracket	252	550
4205	282	486	Ball Stud	Ball Stud	204	250
4207	356	638	Ball Stud	Ball Stud	282	400
4221	304	514	Ball Stud	Ball Stud	210	550
4260	346	597	Socket	Socket	251	350
4268	150	227	Clevis	Clevis	77	470
4269	206	296	Socket	Socket	90	480
4270	215	353	Clevis	Clevis	138	320
4271	287	497	Ball Stud	Ball Stud	210	150
4272	322	532	Socket	Socket	210	400
4273	353	578	Bracket	Bracket	225	300
4277	332	543	Socket	Socket	211	340
4284	181	288	Clevis	Socket	107	500
4285	168	258	M6 Stud	M6 Stud	90	480
4289	374	625	Clevis	Socket	251	300
4291	181	288	Ball Stud	Ball Stud	107	300
4294	284	488	Socket	Socket	205	250
4295	231	388	Socket	Socket	158	250
4296	284	488	Socket	Socket	205	350



GASLIFTS

SORTED BY PART NUMBERS (CONT...)

Part #	Collapsed Length	Extended Length	Body End	Rod End	Stroke	Force in Newtons
4297	231	388	Socket	Socket	158	350
4298	253	388	Ball Stud	Ball Stud	135	350
4308	274	472	Socket	Socket	198	330
4312	407	723	Socket	Socket	316	250
4313	267	450	Socket	Socket	183	550
4314	290	496	Socket	Socket	206	500
4316	289	485	Socket	Socket	196	530
4319	291	460	Socket	Socket	169	100
4321	416	722	Clevis	Clevis	306	310
4322	372	625	Socket	Socket	253	575
4323	244	404	Socket	Socket	160	390
4324	416	722	Socket	Socket	306	280
4325	295	500	Socket	Socket	205	420
4326	300	500	Socket	Socket	200	690
4327	310	520	Socket	Socket	210	570
4328	289	477	Socket	Socket	188	360
4329	340	540	Socket	Socket	200	400
4330	300	510	Socket	Socket	210	340
4331	282	458	Socket	Socket	176	430
4332	364	624	Socket	Socket	260	340
4333	315	525	Socket	Socket	210	140
4501	170	256	Socket	Socket	86	700
4502	285	493	Bracket	Ball Stud	208	800
4515	307	525	Socket	Clevis	218	600
4516	307	525	Socket	Clevis	218	600
4521	492	713	Clevis	Clevis	221	600
4522	492	713	Clevis	Clevis	221	600



STEERING DAMPERS PARTS LISTING

Part #	Product	Superseding Part # status	Product Type	Position	Year	Make	Model	Derivative
14004	Steering Damper		Fig 15	Front	52-79	Volkswagen	Beetle	PC
14011	Steering Damper		Fig 15	Front	76-98	Land Rover	Range Rover, Discovery	SUV
14011	Steering Damper		Fig 15	Front	76-94	Land Rover	Range Rover	SUV
14012	Steering Damper		Fig 15	Front	81-84	Audi	100,2	PC
14012	Steering Damper		Fig 15	Front	Mar-81	Isuzu	KB, TF Series	4x2, 4x4
14013	Steering Damper		Fig 15	Front	65-84	Land Rover	Defender	109",110" WB, Series 11, 111
14014	Steering Damper		Fig 15	Front	78-97	Opel	Commodore, Rekord	(Incl. 2500,3800,4100)
14021	Steering Damper		Fig 15	Front	79-98	Toyota	Hilux	4x4
14022	Steering Damper		Fig 15	Front	82-90	Nissan	Patrol	4x4
14022	Steering Damper		Fig 15	Front	82-90	Nissan	Safari	SUV
14023	Steering Damper		Fig 15	Front	71-85	Toyota	Landcruiser	FJ45, BJ45
14024	Steering Damper		Fig 15	Front	90-98	Toyota	Landcruiser	HZJ 80
14024	Steering Damper		Fig 15	Front	83-99	Toyota	Landcruiser	FJ62, BJ60, BJ75
14032	Steering Damper		Fig 15	Front	Jul-84	Land Rover	Defender	90, 110 , 130 (incl. Defender,County)
14033	Steering Damper		Fig 15	Front	May-99	Toyota	Hilux	4x4
14040	Steering Damper		Fig 15	Front	Jan-93	Chrysler	Jeep	Cherokee
14040	Steering Damper		Fig 15	Front	Jun-96	Chrysler	Jeep	Wrangler 4x4 (TJ)

STEERING DAMPERS TECHNICAL INFORMATION

Collapsed Length	Extended Length	Upper Mounting	Lower Mounting	Accessory Kit	Product Type	Part #
287	444	SE	SM	...	Fig. 15	14004
306	525	9.5mm Stud	9.5mm Stud	...	Fig. 15	14011
308	501	RE16	SE10x35	500498	Fig. 15	14040
313	540	11mm Stud	11mm Stud	...	Fig. 15	14013
313	544	9.5mm Stud	9.5mm Stud	140126	Fig. 15	14016
318	539	10mm Stud	SE10x24	...	Fig. 15	14014
322	458	RE16	RE16	...	Fig. 15	14023
328	540	RE16	RE16	...	Fig. 15	14022
335	563	SE10x24	SE10x24	144215	Fig. 15	14012
340	540	9.5mm Stud	RE17	...	Fig. 15	14021
360	609	RE16	RE16	142387	Fig. 15	14017
363	613	SE10x24	RE16	...	Fig. 15	14033
411	674	RE16	RE16	...	Fig. 15	14024
439	677	9.5mm Stud	SE10x26	...	Fig. 15	14032

TERMS & CONDITIONS

WARRANTY POLICY

WARRANTY ON GABRIEL SHOCK ABSORBERS

1. This warranty is expressed in lieu of All other warranties and representations express or implied.
2. Gabriel SA warrants that All products supplied to its customers comply with the relevant industry quality standards.
3. The Gabriel shock absorbers warranty is in accordance to the following schedule, subject to the specific restrictions and or warranty limitations which are detailed below.
 - 3.1 Gabriel® shock absorbers used on passenger cars and light commercial vehicles (up to 1 000 kg load capacity), are warranted for a period of 36 (thirty six) months from the date of purchase. This only applies in South Africa, Botswana, Namibia, Swaziland and Lesotho. Zimbabwe, Zambia, Malawi and Mozambique have a warranty as per 3.2 below on All vehicle types. All other countries terms and conditions are available on enquiry.
 - 3.2 Gabriel® shock absorbers used on All other types of vehicles are warranted for a period of 12 (twelve) months from date of sale to user, or 20 000 km, whichever occurs first.
 - 3.3 Gabriel® gas-springs (Gabriel Gaslift®), both industrial and automotive are warranted for a period of 12 (twelve) months from date of sale to user.
- 3.4 From time to time, Gabriel SA may run promotions or programs that strengthen the standard Gabriel Warranty Policy. In All circumstances, Gabriel SA will clearly state any changes to the Original Warranty in All of its communications. If a warranty is requested under the provisions of one of these programs or promotions, Gabriel SA will always ensure that it is processed in line with the specific terms and conditions stated.
4. The Gabriel SA warranty covers All manufacturing defects, but does not cover normal deterioration of product through normal use. Gabriel SA warrants that the products manufactured and or distributed shall be free from defects in material and workmanship.
5. Any product, in respect of which a manufacturing defect has been found, may be returned to Gabriel SA within its warranty period in order for it to be repaired or replaced or to have the purchase price of the product repaid, at Gabriel SA's discretion. The replacement unit will be similarly warranted but only for the balance of the duration of the original warranty.

CONSUMER PROTECTION ACT WARRANTIES

6. In terms of the Consumer Protection Act No. 68 of 2008 (CPA), in the event that a product supplied by Gabriel SA is unsuitable for its intended purpose, of poor quality, not in a good working order, defective, sub-standard or wears out before the reasonable service life of the product and the product is returned to Gabriel SA within six months after delivery of the product to the buyer, Gabriel SA will:
 - a) Repair the product;
 - b) Replace the product; or
 - c) Refund the price of the product.
7. In terms of the CPA, if Gabriel SA is directed to repair the product and within 3 months after that repair, that repair is ineffective or a further problem with the product is discovered, Gabriel SA will then replace the product or refund the price of the product.
8. Gabriel SA will have the right not to provide the remedies set out above to the extent that the CPA does not oblige Gabriel SA to do so in the circumstances of a particular case.

GENERAL CONDITIONS, RESTRICTIONS AND LIMITATIONS

9. The buyer of the product must make use of Gabriel SA's returns policy and claims procedure, available on the Gabriel website www.gabriel.co.za, or available directly from the company or any of its representatives. Except to the extent impermissible in terms of the CPA, no warranty claims will be approved by Gabriel SA unless these returns policy and claims procedures are followed.
10. Notwithstanding the returns policy but subject to the CPA, Gabriel SA reserves the right to at any stage reject the return of goods, should it feel that the goods have been abused or that the goods have deteriorated through excessive use within the warranty period. Gabriel SA shall then have the option to return the rejected goods to the buyer.
11. Gabriel SA shall not be liable for damages resulting from delays in shipment or inability to ship due to normal production and shipment delays or those resulting from acts of God, fires, floods, wars, sabotage, accidents, labour disputes or shortages, plant shutdown or equipment failure, voluntary or involuntary compliances with any law, order, rule or regulation of governmental agency or authority; or inability to obtain material (including power and fuel), equipment or transportation, or arising from any other contingency, circumstances or event beyond the control of Gabriel SA.
12. All Gabriel products are fit for purpose for which they have been supplied. In the case of products listed in this catalogue, products should only be used on the vehicles described and under operating conditions appropriate to these vehicles. The warranty does not extend to vehicles with lowered or modified suspensions and only to goods where the user can prove that such goods became defective in normal and proper use.
13. Except to the extent permissible in terms of the CPA, Gabriel SA will not be liable for any loss of profit or any consequential loss or damage, from whatever cause arising, including loss of any labour or fitment costs.
14. The above warranty only applies within the warranty period and when proof of purchase can be verified. A copy of the customer's original purchase invoice is required for All warranty claims. The customer's details should be provided with the claim.
15. Under no circumstances will warranty claims be entertained if the piston rod of the faulty unit has sustained any damage that appears to have been inflicted by tools
16. The warranty will be void if bump rubbers are not used.

PROCESSING WARRANTIES

For your ease and convenience, Gabriel SA have created a single telephone number to register either a Warranty or an Extended Warranty.
This number is **0861 GABRIEL (0861 422 7435)**

REGISTERING A NORMAL GABRIEL WARRANTY

- 1) To assist in the quick processing of claims through the Warranty Call Centre, it is important to have the following information with you prior to making the call:
 - a. The vehicle make, model and year that the part was fitted to.
 - b. The claimed product part number
 - c. The claimed manufacturing date code (required unless the product is still fitted)
 - d. The original invoice with date of issue and invoice number
 - e. The type of fault or customer complaint (this relates to the documented fault codes presented in the catalogue)
 - f. The motorist's name and phone number (optional)
 - g. The extended warranty registration number (if applicable)
- 2) Call 0861 GABRIEL (0861 422 7435) and request to log a standard Warranty Claim
- 3) A call centre agent will ask you the questions stated in No.1 above and should the answers fall in line with our warranty policy, a preauthorisation claim number will be issued (RMA Number). It is this number that is to be recorded along with your own request for credit documentation (RFC) back to your product supplier. We advise that this RMA number is physically written on the product with either a Black or White paint pen prior to returning the product back.
- 4) Should an RMA not be issued, the reason will be explained to you by the call center agent.
- 5) Gabriel SA can allow you the option to submit your requests for credit with your supplier, however you must first confirm with your supplier that they are happy to receive a claimed product without an RMA number. Further there are no guarantees that the claim will be honoured, as this is based on an inspection required by a Gabriel Representative who may reject the claim.
- 6) In line with its Warranty Policy, Gabriel honours All of its product from any store that a warranty is claimed from, irrespective of where the customer initially purchased the product from. If you are not the original seller, it is still your responsibility to validate if a customer has a valid claim and to process the claim in line with this procedure. We so advise that you make a copy of the claimed invoice for your records.
- 7) For further enquiries, please feel free to contact our offices or your Gabriel Representative.
- 8) See below for warranty fault codes required for your registration.

GABRIEL WARRANTY FAULT CODES

NO	NAME	DESCRIPTION
0	No fault found	There is nothing functionally wrong With the shocks
1	Fluid leak (Bottom)	Oil leak through bottom mounting/weld (Very rare)
2	Fluid leak (Top)	Oil leak through top seal
3	Mounting Bracket, Spring Seat or Rod broken	Visual inspection to see if one of the three is broken
4	Mounting rubber/sleeve failure	Worn out rubbers or rubber mountings that have moved out of the mounting
5	Loose dust cover/cap	Only applies to metal dust covers that rattle if weld has broken
6	No resistance	The rod will move up & down With no resistance
7	Low resistance/Soft (Check whether gas or non-gas)	It will take a little effort to compress
8	Seized/binding	Shaft will not move at all - in or out
9	Knocking Noise (Lag Effect)	Can only be checked off the vehicle. Takes experience to pick this up.
10	High resistance	Will take a lot of effort to move but could be in spec
11	Gas loss	Rod will not extend on its own
12	Squeaking noise	Dry squeaking sound coming from the shock
13	Grunting noise	More or less same as squeak but deeper
14	Safety critical fault	Anything broken on a strut or spring seat unit only
15	Failed By A Tester	Shocks have been failed by some type of suspension/shock testing equipment

8 SIGNS OF WORN SHOCKS

Be safe. Be sure



www.gabriel.co.za



[GabrielShocksZA](https://www.facebook.com/GabrielShocksZA)



[gabrielshocksza](https://twitter.com/gabrielshocksza)





Core Brands of Torre Parts and Components



Be safe. Be sure



HEAD OFFICE

JOHANNESBURG

Torre Parts and Components

59 Merino Avenue, City Deep, Johannesburg, South Africa

P.O. Box 86222, City Deep, 2049, South Africa

Tel: +27(0)11 627 2500

Fax: +27(0)11 627 2600

Sharecall: 0861 242 886

info@torreparts.com

www.torreparts.com



www.gabriel.co.za



Gabriel Shocks ZA



[gabrielshocksza](https://twitter.com/gabrielshocksza)



3.5M.08.17

Download a recognised QR reader on your mobile device for quick access to the Gabriel web page.